

READ BEFORE USE

Visit www.hamiltonbeach.in for our complete line of products and Use and Care Guides – as well as delicious recipes, tips, and other useful information!

**Questions?
Please call us – our friendly
associates are ready to help.
1.800.42.555.43**

Hamilton Beach®

Panini Press



IMPORTANT SAFEGUARDS

When using electrical appliances, basic safety precautions should always be followed, including the following:

1. Read all instructions.
2. This appliance is intended to be used in household and similar applications such as: staff kitchen areas in shops, offices, and other working environments; farm houses; by clients in hotels, motels, and other residential-type environments; bed and breakfast-type environments.
3. Do not touch hot surfaces. Use handles or knobs.
4. To protect against risk of electrical shock, do not immerse appliance, cord, or plug in water or other liquid.
5. This appliance can be used by children aged from 8 years and above and persons with reduced physical, sensory, or mental capabilities or lack of experience and knowledge if they have been given supervision or instruction concerning use of the appliance in a safe way and understand the hazards involved. Children shall not play with the appliance. Cleaning and user maintenance shall not be made by children without supervision.
6. Close supervision is necessary when any appliance is used by or near children. Keep the appliance and its cord out of reach of children less than 8 years.
7. Unplug from outlet when not in use and before cleaning. Allow to cool before putting on or taking off parts, and before cleaning the appliance.
8. Do not operate any appliance with a damaged supply cord, or after the appliance malfunctions or is dropped or damaged in any manner. Supply cord replacement and repairs must be conducted by the manufacturer, its service agent, or similarly qualified persons in order to avoid a hazard.
9. Do not use outdoors.
10. The use of attachments not recommended or sold by the appliance manufacturer for use with this model may cause fire, electric shock, or injury.
11. Do not let cord hang over edge of table or counter or touch hot surfaces, including stove.
12. Do not place on or near a hot gas or electric burner, or in a heated oven.
13. Extreme caution must be used when moving an appliance containing hot oil or other hot liquids.
14. Do not use appliance for other than intended purpose.
15. Do not operate the appliance by means of an external timer or separate remote-control system.
16. **⚠ CAUTION: HOT SURFACE.** The temperature of accessible surfaces may be high when the appliance is operating.

SAVE THESE INSTRUCTIONS!

Other Consumer Safety Information

To reduce risk of electrical shock, do not immerse the unit in water.

To avoid an electrical circuit overload, do not use another high-wattage appliance on the same circuit with this appliance.

Always use an oven mitt to protect hand when opening the grill.

CAUTION! Burn Hazard: Escaping steam may cause burns.

Parts and Features

BEFORE FIRST USE: Wash the cooking surfaces of the panini press as instructed under "Care and Cleaning."

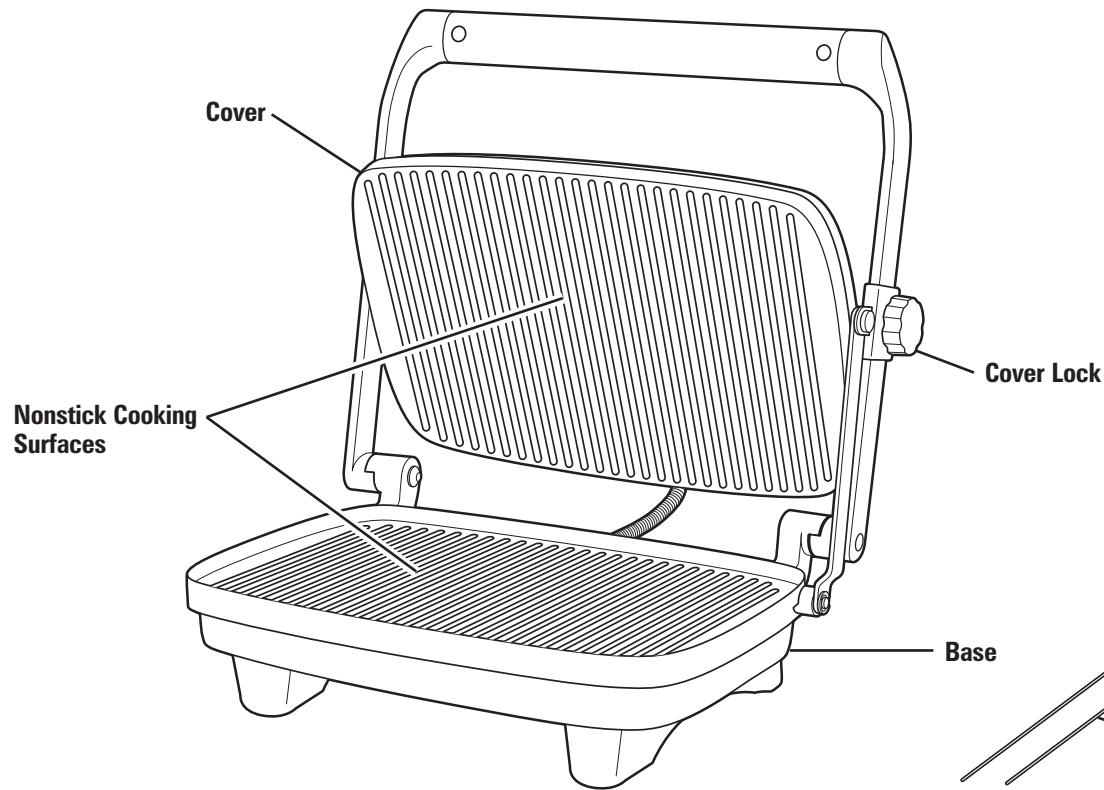

Red Power ON Light

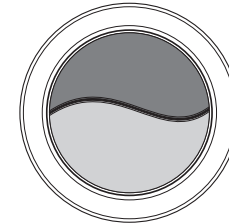

Green Preheat Light

Indicator Lights

Your panini press features two indicator lights. Red indicates that power is on. Green indicates that the unit is preheated and ready to use.

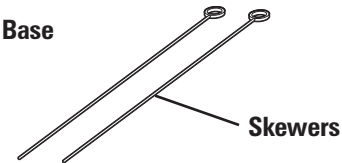

How to Grill

⚠ WARNING Burn Hazard.
Exterior becomes hot. Use an oven mitt when cooking.

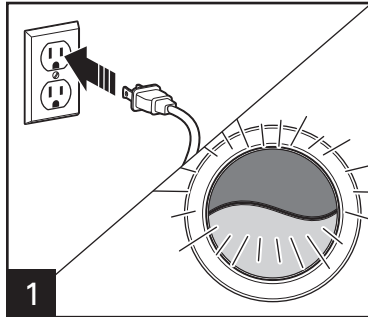

Plug cord into wall outlet. The red light will glow.

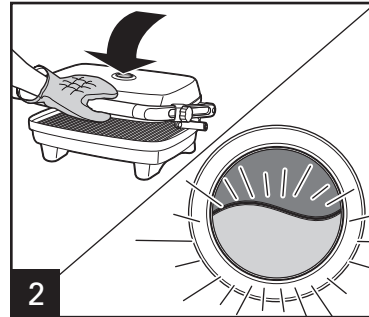

Preheat panini press for 6 minutes with cover closed. Once the grill has reached the proper temperature, the green light will come on.

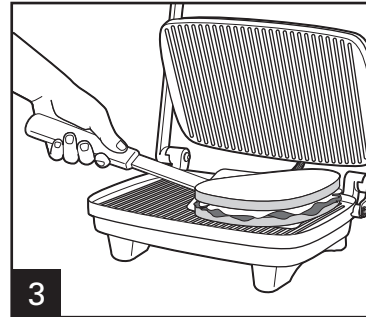

When preheated, raise cover. Place food to be cooked onto cooking surface and lower cover to desired height. Lock the cover at the desired height by turning the cover lock, if desired.

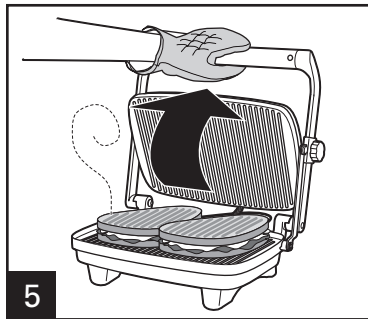
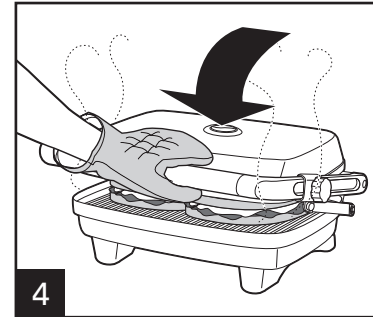

Unlock the cover; then use an oven mitt and carefully lift cover and check food to see if cooked to desired doneness.

Do not cut food on nonstick cooking surface. If additional cooking time is needed, lower cover.

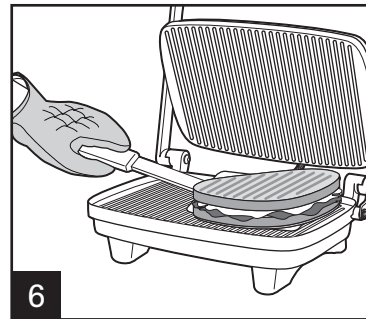

When food is cooked to desired doneness, remove the food and unplug the panini press. Let cool before cleaning.

Panini Press Tips

ALWAYS PREHEAT THE PANINI PRESS FOR 6 MINUTES BEFORE USING.

- Read the Use and Care Guide before using the panini press.
- Brush cooking grids with vegetable oil before preheating to prevent foods from sticking.
- Use plastic utensils on the nonstick cooking surfaces. Do not use metal utensils since they will damage the nonstick surface.
- Thicker sandwiches may shift when being pressed. Use a plastic spatula to reposition. Place sandwich in center of press.
- When a recipe calls for fruit, lock the cover in place above the fruit so that it heats but does not contact the fruit.
- There is no need to press down on the handle. The weight of the cover will grill the top of the sandwich.
- Cleanup is easy! Let panini press cool down. Wipe cooking surfaces with damp paper towel or dishcloth.
- Do not latch the storage latch with anything between the grids—this could break the storage latch.

Care and Cleaning



WARNING

Electrical Shock Hazard.

Disconnect power before cleaning. Do not immerse cord, plug, or base in water or any liquid.

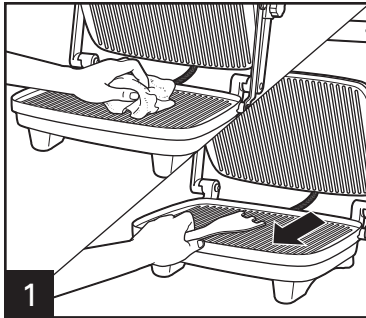

1

Unplug grill from outlet and allow to cool.

Wipe cooking surfaces with a paper towel to remove drippings. Use a plastic spatula to scrape away cooked-on food or grease.

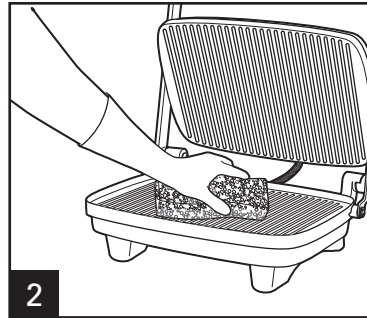

2

Use a damp sponge with a small amount of dishwashing detergent to scrub cooking surfaces. See illustration. Rinse out sponge and wipe surfaces clean. Use a clean, damp cloth to wipe surfaces again.

Do not use steel wool, scouring pads, or abrasive cleansers on any part of the unit. Never use sharp or pointed objects for cleaning.

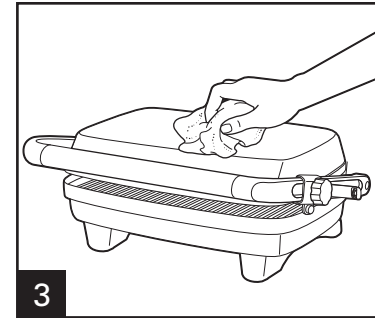

3

Wipe outside of unit with a damp, soapy cloth.

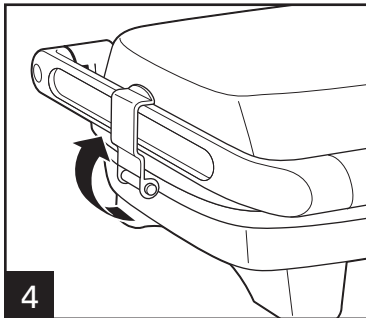

4

The unit can be stored with the lid latch locked, sitting upright on the hinge side.

6

Recipes

Chicken Quesadilla

4 flour tortillas
2 cups (473 ml) chicken, cooked and chopped,
divided into four servings
1/2 cup (118 ml) cheddar cheese, shredded

Directions:

Preheat grill. Fold tortilla in half. Place on cooking grid. Insert chicken and 2 Tablespoons (30 ml) cheese in tortilla. Close cover. Cook 2 to 3 minutes or until cheese melts. Remove from grill and cut into 3 triangles. Repeat with remaining ingredients.

Makes 4 quesadillas.

Quick Pizza

1 can refrigerator pizza crust 8 green pepper rings (optional)
1 cup (237 ml) pizza sauce 4 fresh mushrooms, sliced
1 cup (237 ml) mozzarella cheese, (optional)
shredded

Directions:

Preheat grill. Open refrigerator pizza crust and cut into four oblong pieces. Place 1 piece of pizza crust onto cooking grid. Close cover. Cook 1 to 2 minutes. Open cover and top crust with pizza sauce, mozzarella cheese, and optional toppings. Lower cover and lock hinge to rest above pizza. Cook for 2 to 3 minutes, or until cheese melts. Repeat with remaining ingredients.

Makes 4 servings.

Tomato Bruschetta

2 large ripe red tomatoes (about 1 1/4 pounds [567 g]), cored,
seeded, and diced
1/2 cup (118 ml) extra-virgin olive oil, divided
1/2 cup (118 ml) coarsely chopped fresh basil
2 Tablespoons (30 ml) peeled and diced red onion
2 cloves garlic, peeled and minced
1 teaspoon (5 ml) balsamic vinegar
Salt and pepper, to taste
12 slices crusty French bread, cut diagonally, about 3/4-inch thick

Directions:

Preheat grill to medium-high. In medium bowl, combine the tomatoes, 2 Tablespoons of the olive oil, basil, red onion, garlic, vinegar, salt, and pepper. Cover and let stand at room temperature for at least 30 minutes but not longer than 2 hours. Brush both sides of bread slices with remaining olive oil; place on the grid. Grill for 4 to 5 minutes or until the bread is lightly toasted and golden on both sides, turning once. Stir tomato mixture; top each bread slice with about 1 1/2 Tablespoons of the tomato mixture. Serve immediately.

Makes 6 to 8 servings.

Limited Warranty

CUSTOMER NAME: _____
ADDRESS: _____
PHONE NUMBER: _____
MODEL NUMBER: _____
DATE OF PURCHASE: _____ BILL NUMBER: _____

NAME OF DEALER: _____
DEALER'S SIGNATURE: _____
CUSTOMER'S SIGNATURE: _____
STAMP:

SERIAL NUMBER:

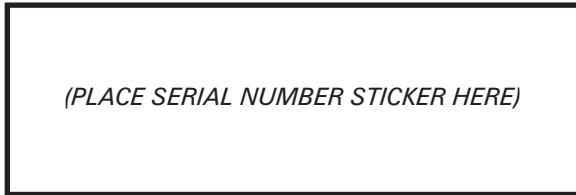

EXPIRY DATE:

SHOULD ANY DEFECT IN MATERIAL OR WORKMANSHIP DEVELOP IN THE PRODUCT,

- CALL 1.800.42.555.43 OR VISIT www.hamiltonbeach.in FOR SERVICE CENTER LOCATIONS OR
- KINDLY TAKE THE PRODUCT TO THE PLACE OF PURCHASE OR
- CALL 1.800.42.555.43 FOR SERVICE AT HOME¹

THE PRODUCT OR ANY COMPONENT OF PRODUCT FOUND TO BE DEFECTIVE WILL BE REPAIRED OR REPLACED FREE OF CHARGE DURING THE WARRANTY PERIOD OF 2 YEARS, FROM THE DATE OF PURCHASE. IF THE PRODUCT OR COMPONENT IS NO LONGER AVAILABLE, WE WILL REPLACE WITH A SIMILAR ONE OF EQUAL OR GREATER VALUE.

¹At-home service is limited to certain geographical areas in India; please call 1.800.42.555.43 for further details.

840234500

VALIDITY:

- THIS WARRANTY IS ISSUED SUBJECT TO THE PRODUCTION AND VERIFICATION OF THE ORIGINAL PROOF OF PURCHASE.
- THIS WARRANTY IS VALID IN INDIA ONLY AND IF PRODUCT HAS BEEN PURCHASED FROM AN AUTHORIZED HAMILTON BEACH DEALER.
- THIS WARRANTY DOES NOT COVER GLASS, FILTERS, WEAR FROM NORMAL USE, USE NOT IN CONFORMITY WITH THE PRINTED DIRECTIONS, OR DAMAGE TO THE PRODUCT RESULTING FROM ACCIDENT, ALTERATION, ABUSE, OR MISUSE. THIS WARRANTY ONLY EXTENDS TO THE ORIGINAL CONSUMER PURCHASER OR THE GIFT RECIPIENT.

THE WARRANTY WILL BE CONSIDERED INVALID IF:

- PRODUCT HAS NOT BEEN USED PER THE MANUFACTURER'S OPERATING INSTRUCTIONS.
- PRODUCT HAS BEEN SERVICED, REPAIRED, OPENED, OR TAMPERED WITH BY ANY UNAUTHORIZED PERSON.
- UNAUTHORIZED CORRECTION/ALTERATIONS IN INVOICE COPY/INSTALLATION NOTE/SERIAL NUMBER OF PRODUCT.
- INCOMPLETE WARRANTY CARD AFTER PURCHASE.
- ANY ATTACHMENTS NOT RECOMMENDED BY THE MANUFACTURER HAVE BEEN USED ON THE PRODUCT.
- PRODUCT IS USED FOR OTHER THAN SINGLE-FAMILY HOUSEHOLD USE OR SUBJECTED TO ANY VOLTAGE AND WAVEFORM OTHER THAN 220-240V~/50Hz.

7/13