



USER MANUAL

WB1100F/WB1101F/WB1102F

Click a topic

This user manual includes detailed usage instructions for your camera. Please read this manual thoroughly.

Basic troubleshooting	Quick reference	Contents
Basic functions	Extended functions	Shooting options
Playback/Editing	Wireless network	Settings
Appendixes	Index	

SHOOT WOW!
SHARE NOW!



Health and safety information

Always comply with the following precautions and usage tips to avoid dangerous situations and ensure peak performance of your camera.



Warning—situations that could cause injury to yourself or others

Do not disassemble or attempt to repair your camera.

You can damage the camera and expose yourself to the risk of an electric shock.

Do not use your camera near flammable or explosive gases and liquids.

This may cause a fire or explosion.

Do not insert flammable materials into the camera or store these materials near the camera.

This may cause a fire or electric shock.

Do not handle your camera with wet hands.

This may result in an electric shock.

Prevent damage to subjects' eyesight.

Do not use the flash in close proximity (closer than 1 m/3 ft) to people or animals. If you use the flash too close to your subject's eyes, this can cause temporary or permanent eyesight damage.

Keep your camera away from small children and pets.

Keep your camera and all accessories out of the reach of small children and animals. Small parts may cause choking or serious injury if swallowed. Moving parts and accessories may present physical dangers as well.

Do not expose the camera to direct sunlight or high temperatures for an extended period of time.

Prolonged exposure to sunlight or extreme temperatures can cause permanent damage to your camera's internal components.

Avoid covering the camera or charger with blankets or clothes.

The camera may overheat, which may distort the camera or cause a fire.

Do not handle the power supply cord or the charger during a thunderstorm.

This may result in electric shock.

If liquid or foreign objects enter your camera, immediately disconnect all power sources, such as the battery or charger, and then contact a Samsung service center.

Comply with any regulations that restrict the use of a camera in a certain area.

- Avoid interference with other electronic devices.
- Turn off the camera when in an aircraft. Your camera can cause interference with aircraft equipment. Follow all airline regulations and turn off your camera when directed by airline personnel.
- Turn off the camera near medical equipment. Your camera can interfere with medical equipment in hospitals or health care facilities. Follow all regulations, posted warnings, and directions from medical personnel.

Avoid interference with pacemakers.

Maintain a safe distance between this camera and all pacemakers to avoid potential interference, as recommended by the manufacturer and research groups. If you have any reason to suspect that your camera is interfering with a pacemaker or other medical device, turn off the camera immediately and contact the manufacturer of the pacemaker or medical device for guidance.



Caution—situations that could cause damage to your camera or other equipment

Remove the batteries from your camera when storing it for an extended period of time.

Installed batteries may leak or corrode over time and cause serious damage to your camera.

Use only authentic, manufacturer-recommended, Lithium-ion replacement batteries. Do not damage or heat the battery.

Inauthentic, damaged, or heated batteries may cause a fire or personal injury.

Use only Samsung-approved batteries, chargers, cables and accessories.

- Using unauthorized batteries, chargers, cables or accessories can cause batteries to explode, damage your camera, or cause injury.
- Samsung is not responsible for damage or injuries caused by unapproved batteries, chargers, cables or accessories.

Use the battery only for its intended purpose.

Misusing the battery may cause a fire or electric shock.

Do not touch the flash while it fires.

The flash is very hot when fired and may burn your skin.

When you use the AC charger, turn off the camera before you disconnect the power to the AC charger.

Failing to do so may result in fire or electric shock.

Disconnect the charger from the wall socket when not in use.

Failing to do so may result in fire or electric shock.

Do not use a damaged power supply cord, plug, or loose outlet when you charge batteries.

This may cause a fire or electric shock.

Do not allow the AC charger to come in contact with the +/- terminals on the battery.

This may cause a fire or electric shock.

Do not drop or subject the camera to strong impacts.

Doing so may damage the screen or external or internal components.

Exercise caution when you connect cables or adapters and install batteries and memory cards.

If you force the connectors, improperly connect cables, or improperly install batteries and memory cards, you can damage ports, connectors, and accessories.

Keep cards with magnetic strips away from the camera case.

Information stored on the card may be damaged or erased.

Never use a damaged charger, battery, or memory card.

This may result in electric shock or camera malfunction or cause a fire.

Do not place the camera in or near magnetic fields.

Doing so may cause the camera to malfunction.

Do not use the camera if the screen is damaged.

If the glass or acrylic parts are broken, visit a Samsung Electronics Service Center to have the camera repaired.

Check that the camera is operating properly before use.

The manufacturer takes no responsibility for any loss of files or damage that may result from camera malfunction or improper use.

You must plug the small end of the USB cable into your camera.

If the cable is reversed, it may damage your files.

The manufacturer is not responsible for any loss of data.

Avoid interference with other electronic devices.

Your camera emits radio frequency (RF) signals that may interfere with unshielded or improperly shielded electronic equipment, such as pacemakers, hearing aids, medical devices, and other electronic devices in homes or vehicles. Consult the manufacturers of your electronic devices to solve any interference problems you experience. To prevent unwanted interference, use only Samsung-approved devices or accessories.

Use your camera in the normal position.

Avoid contact with your camera's internal antenna.

Data transference and your responsibilities

- Data transferred via WLAN could be leaked, so avoid transferring sensitive data in public areas or on open networks.
- The camera manufacturer is not liable for any data transfers that infringe on copyrights, trademarks, intellectual property laws, or public decency ordinances.

Copyright information







- Microsoft Windows and the Windows logo are registered trademarks of the Microsoft Corporation.
- Mac and Apple App Store are registered trademarks of the Apple Corporation.
- Google Play Store is a registered trademark of Google, Inc.
- Wi-Fi®, the Wi-Fi CERTIFIED logo, and the Wi-Fi logo are registered trademarks of the Wi-Fi Alliance.
- Trademarks and trade names used in this manual are the property of their respective owners.

- Camera specifications or contents of this manual may be changed without prior notice due to upgrade of camera functions.
- We recommend using your camera within the country where you purchased.
- Use this camera responsibly and adhere to all laws and regulations concerning its use.
- You are not allowed to reuse or distribute any part of this manual without prior permission.

Outline of the User Manual



Basic functions	19
Learn about your camera's layout, icons, and basic functions for shooting.	
Extended functions	43
Learn how to capture a photo and record a video by selecting a mode.	
Shooting options	53
Learn how to set the options in Shooting mode.	
Playback/Editing	74
Learn how to play back photos or videos, and edit photos or videos. Also, learn how to connect your camera to your computer or TV.	
Wireless network	92
Learn to connect to wireless local area networks (WLANs) and use functions.	
Settings	109
Refer to options to configure your camera's settings.	
Appendixes	115
Get information about error messages, specifications, and maintenance.	

Indicators used in this manual

Shooting mode	Indicator
Smart Auto	
Program	P
Smart	
Panorama	
Magic Plus	
Settings	
Movie	
Wi-Fi	Wi-Fi

Shooting mode icons

These icons appear in the text when a function is available in a mode. See the example below.

Note: The  or  mode may not support functions for all scenes or modes.

For example:

Adjusting the exposure manually (EV) 

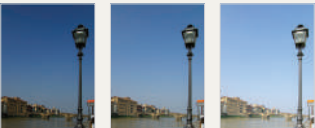

Depending on the intensity of the ambient light, your photos may be too bright or dark. In these cases, you can adjust the exposure to get a better photo.



▲ Darker (-) ▲ Neutral (0) ▲ Brighter (+)

Available in Program and Movie modes

Icons used in this manual

Icon	Function
	Additional information
	Safety warnings and precautions
[]	Camera buttons. For example, [Shutter] represents the shutter button.
()	Page number of related information
→	The order of options or menus you must select to perform a step; for example: Select Face Detection → Normal (represents Select Face Detection , and then select Normal).
*	Annotation

Expressions used in this manual

Pressing the shutter

- Half-press [**Shutter**]: Press the shutter halfway down
- Press [**Shutter**]: Press the shutter all the way down

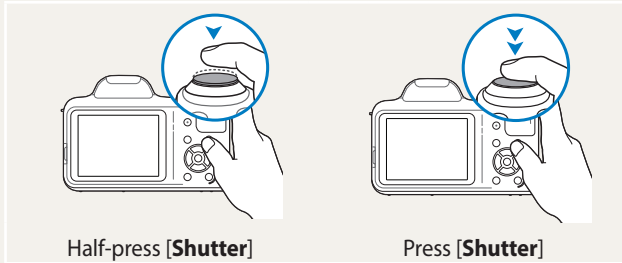

Subject, background, and composition

- **Subject**: The main object in a scene, such as a person, animal, or still life
- **Background**: The objects around the subject
- **Composition**: The combination of a subject and background

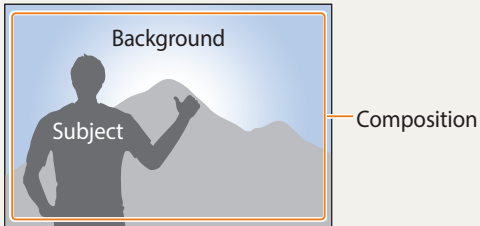

Exposure (Brightness)

The amount of light that enters your camera determines the exposure. You can alter the exposure by changing the shutter speed, aperture value, or ISO sensitivity. By altering the exposure, your photos will be darker or lighter.



▲ Normal exposure

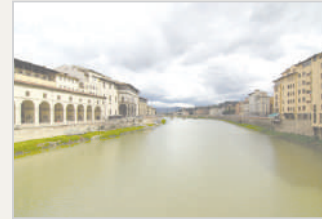

▲ Overexposure (too bright)

Special features of your camera

Using the DIRECT LINK button



Press the DIRECT LINK button to activate the Wi-Fi function that you have designated.

Setting a DIRECT LINK button option

You can select a Wi-Fi function to launch when you press the DIRECT LINK button.

- 1 Access Settings.

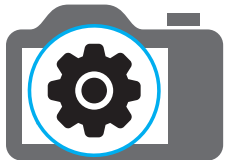

- 2 Access the DIRECT LINK button option.
- 3 Select a Wi-Fi feature from the list.

Reading NFC tag information (Tag & Go)

Install the Samsung SMART CAMERA App on an NFC-enabled device, and then place the device's NFC antenna near the camera's NFC tag. The Samsung SMART CAMERA App launches automatically. If the app is not installed, a prompt to install the app will appear.



Special features of your camera

Using AutoShare

When you capture a photo with your camera, the photo is saved to a smart phone automatically. The camera connects to the smart phone wirelessly.

- 1 Install **Samsung SMART CAMERA App** on the smart phone.

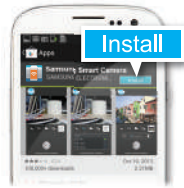

- 2 Turn on the **AutoShare** feature on the camera.



- 3 Launch **Samsung SMART CAMERA App** on the smart phone.



- 4 Select the camera from the list and connect the smart phone to the camera.

- If a pop-up message appears on your camera, allow the smart phone to connect to your camera.



- 5 Capture a photo.

- The captured photo is saved to the camera, and then transferred to the smart phone.

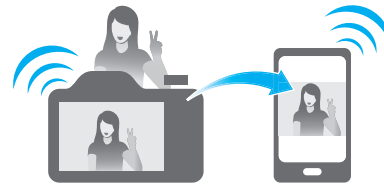

Special features of your camera

Using MobileLink

You can send files easily from your camera to a smart phone. The camera connects wirelessly to smart phones that support the MobileLink feature.

- 1 Install the **Samsung SMART CAMERA App** on the smart phone.



- 2 Access the **MobileLink** mode on the camera.
 - If a pop-up message appears, select an option.

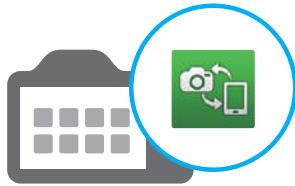

- 3 Launch the **Samsung SMART CAMERA App** on the smart phone.



- 4 Select the camera from the list and connect the smart phone to the camera.
 - If a pop-up message appears on your camera, allow the smart phone to connect to your camera.



- 5 On the smart phone or camera, select files to transfer from the camera.



- 6 On the smart phone, touch the copy button or on the camera, select **Send**.



Special features of your camera

Using Remote Viewfinder

You can remotely control your camera from a smart phone. The camera connects to the smart phone wirelessly. Use the smart phone as a remote shutter release with the Remote Viewfinder feature. The captured photo will appear on the smart phone.

- 1 Install the **Samsung SMART CAMERA App** on the smart phone.



- 2 Access the **Remote Viewfinder** mode on the camera.



- 3 Launch the **Samsung SMART CAMERA App** on the smart phone.



- 4 Select the camera from the list and connect the smart phone to the camera.

- If a pop-up message appears on your camera, allow the smart phone to connect to your camera.



- 5 Touch and hold  to focus, and then release it to capture a photo.



- 6 Touch the thumbnail to view the photo.



Special features of your camera

Shooting samples – Macro

You can capture close up shots of a subject or small subjects, such as flowers or insects.



The example image may differ from the actual photo that you capture.

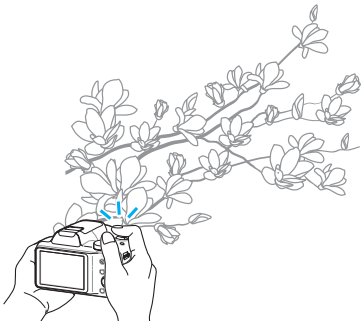

- 1 Select the macro option (🌷).





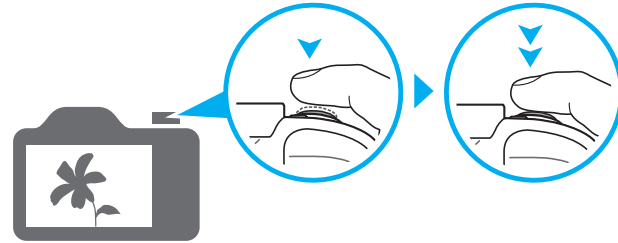







- 2 Capture a photo.



Basic troubleshooting

Learn to solve common problems by setting shooting options.

	The subject's eyes appear red.	<p>Red eye occurs when the subject's eyes reflect light from the camera flash.</p> <ul style="list-style-type: none">• Set the flash option to  Red-eye or  Red-eye Fix. (p. 57)• If the photo has already been captured, select  Red-eye Fix in the edit menu. (p. 86)
	Photos have dust spots.	<p>If dust particles are present in the air, you may capture them in photos when you use the flash.</p> <ul style="list-style-type: none">• Turn off the flash or avoid capturing photos in a dusty place.• Set ISO sensitivity options. (p. 59)
	Photos are blurred.	<p>Blurring can occur if you capture photos in low light conditions or hold the camera incorrectly. Use the OIS function or half-press [Shutter] to ensure the subject is in focus. (p. 41)</p>
	Photos are blurred when shooting at night.	<p>As the camera tries to let in more light, the shutter speed slows. This can make it difficult to hold the camera steady long enough to capture a clear photo and may result in camera shake.</p> <ul style="list-style-type: none">• Select Night in  mode. (p. 47)• Turn on the flash. (p. 58)• Set ISO sensitivity options. (p. 59)• Use a tripod to prevent your camera from shaking.
	Subjects come out too dark because of backlighting.	<p>When the light source is behind the subject or when there is a high contrast between light and dark areas, the subject may appear too dark.</p> <ul style="list-style-type: none">• Avoid shooting toward the sun.• Set the flash option to  Fill in. (p. 58)• Adjust the exposure. (p. 67)• Set the Auto Contrast Balance (ACB) option. (p. 68)• Set the metering option to  Spot if a subject is in the center of the frame. (p. 68)

Quick reference



Capturing photos of people

- **S** mode > Beauty Face ▶ 47
- Red-eye/Red-eye Fix (to prevent or correct red-eye) ▶ 57
- Face Detection, Self-Portrait ▶ 64
- Smile Shot ▶ 65



Capturing photos at night or in the dark

- **S** mode > Sunset, Silhouette, Fireworks, Light Trace ▶ 47
- Flash options ▶ 58
- ISO sensitivity (to adjust the sensitivity to light) ▶ 59



Capturing action photos

- **S** mode > Action Freeze ▶ 47
- Continuous, Motion Capture ▶ 71



Capturing photos of text, insects, or flowers

- **S** mode > Macro ▶ 47
- Macro ▶ 60



Adjusting the exposure (brightness)

- ISO sensitivity (to adjust the sensitivity to light) ▶ 59
- EV (to adjust exposure) ▶ 67
- ACB (to compensate for subjects against bright backgrounds) ▶ 68
- Metering ▶ 68
- AEB (to capture 3 photos of the same scene with different exposures) ▶ 71



Capturing photos of scenery

- **S** mode > Landscape ▶ 47
- **III** mode ▶ 48



Applying effects to photos

- **★** mode > Photo Filter ▶ 50
- Image Adjust (to adjust Sharpness, Contrast, or Saturation) ▶ 72



Applying effects to videos

- **★** mode > Movie Filter ▶ 51



Reducing camera shake

- Optical Image Stabilization (OIS) ▶ 40
- Dual Image Stabilization (Dual IS) ▶ 40



Sending and sharing files

- Using the NFC Feature (Tag & Go) ▶ 97
- Sending photos or videos to a smart phone ▶ 99
- Sending photos or videos via email ▶ 102
- Using photo or video sharing services ▶ 105
- Viewing photos or videos on devices that support Samsung Link ▶ 107

- Viewing files as thumbnails ▶ 76
- Viewing files by category ▶ 77
- Deleting all files on the memory ▶ 79
- Viewing files as a slide show ▶ 81
- Viewing files on a TV ▶ 88
- Connecting your camera to a computer ▶ 89
- Adjusting sound and volume ▶ 111
- Adjusting the brightness of the display ▶ 112
- Changing the display language ▶ 113
- Setting the date and time ▶ 113
- Before contacting a service center ▶ 128

Contents

Basic functions	19
Unpacking	20
Camera layout	21
Using the DIRECT LINK button	23
Attaching a strap	24
Attaching a lens cap	24
Inserting the battery and memory card	25
Charging the battery and turning on your camera	26
Charging the battery	26
Turning on your camera	26
Performing the initial setup	27
Learning icons	29

Using the Mode screen	31
Selecting a Mode Screen	31
Icons on the Mode screen	32
Selecting options or menus	33
Setting the display and sound	35
Setting the display type	35
Setting the sound	36
Capturing photos	37
Zooming	38
Changing the zoom speed	39
Reducing camera shake (OIS)	40
Tips for getting a clearer photo	41

Extended functions	43
Using the Smart Auto mode	44
Using the Program mode	46
Using the Smart mode	47
Using the Panorama mode	48
Using the Magic Plus mode	50
Using the Photo Filter mode	50
Using the Movie Filter mode	51
Using the Movie mode	52
Shooting options	53
Selecting a resolution and quality	54
Selecting a resolution	54
Setting the photo quality	55
Using the timer	56

Shooting in the dark	57
Preventing red-eye	57
How to use the flash	57
Using the flash	58
Adjusting the ISO sensitivity	59
Changing the camera's focus	60
Using macro	60
Changing the focus option	60
Adjusting the focus area	61
Using Face Detection	64
Detecting faces	64
Capturing a self portrait shot	64
Capturing a smile shot	65
Detecting eye blinking	65
Tips for detecting faces	66

Adjusting brightness and color	67	Editing a video	87
Adjusting the exposure manually (EV)	67	Trimming a video	87
Compensating for backlighting (ACB)	68	Capturing an image from video	87
Changing the metering option	68	Viewing files on a TV	88
Selecting a White Balance setting	69	Transferring files to a computer	89
Using burst modes (continuous, motion capture, AEB)	71	Transferring files to your Windows OS computer	89
Adjusting images	72	Transferring files to your Mac OS computer	90
Reducing the sound of the zoom	73	System Requirements	91
Playback/Editing	74	Wireless network	92
Viewing photos or videos in Playback mode	75	Connecting to a WLAN and configuring network settings	93
Starting Playback mode	75	Connecting to a WLAN	93
Viewing photos	79	Using the login browser	94
Playing a video	82	Network connection tips	95
Editing a photo	83	Entering text	96
Resizing photos	83	Using the NFC Feature (Tag & Go)	97
Rotating a photo	83	Using NFC features in Shooting mode	97
Applying Smart Filter effects	84	Using NFC features in Playback mode (Photo Beam)	97
Adjusting your photos	85	Using NFC features in Wi-Fi mode	97

Saving files to a smart phone automatically	98	Appendixes	115
Sending photos or videos to a smart phone	99	Error messages	116
Using a smart phone as a remote shutter release	100	Camera maintenance	117
Sending photos or videos via email	102	Cleaning your camera	117
Changing email settings	102	Using or storing the camera	118
Sending photos or videos via email	104	About memory cards	120
Using photo or video sharing services	105	About the battery	123
Accessing a sharing service	105	Upgrading Firmware	127
Uploading photos or videos	105	Before contacting a service center	128
Using Samsung Link to send files	107	Camera specifications	131
Viewing photos or videos on devices that support Samsung Link	107	Glossary	135
Settings	109	FCC notice	140
Settings menu	110	Index	142
Accessing the settings menu	110		
Sounds	111		
Display	111		
Connectivity	112		
General	113		

Basic functions

Learn about your camera's layout, icons, and basic functions for shooting.

Unpacking	20	Using the Mode screen	31
Camera layout	21	Selecting a Mode Screen	31
Using the DIRECT LINK button	23	Icons on the Mode screen	32
Attaching a strap	24	Selecting options or menus	33
Attaching a lens cap	24	Setting the display and sound	35
Inserting the battery and memory card	25	Setting the display type	35
Charging the battery and turning		Setting the sound	36
on your camera	26	Capturing photos	37
Charging the battery	26	Zooming	38
Turning on your camera	26	Changing the zoom speed	39
Performing the initial setup	27	Reducing camera shake (OIS)	40
Learning icons	29	Tips for getting a clearer photo	41

Unpacking

The following items are included in your product box.

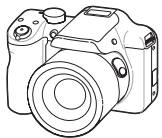

Camera



AC adapter/USB cable

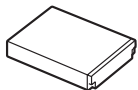

Rechargeable battery

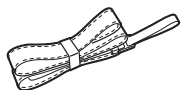

Strap



Lens cap/Lens cap strap

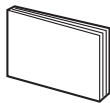

Quick Start Guide

Optional accessories



Camera case

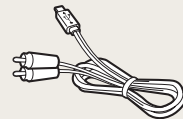

A/V cable

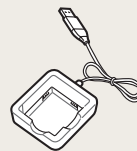

Battery charger

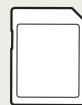

Memory card



Memory card/Memory card adapter



- The illustrations may differ slightly from the items shipped with your product.
- The items included in the box may differ depending on the model.
- You can purchase optional accessories at a retailer or a Samsung service center. Samsung is not responsible for any problems caused by using unauthorized accessories.





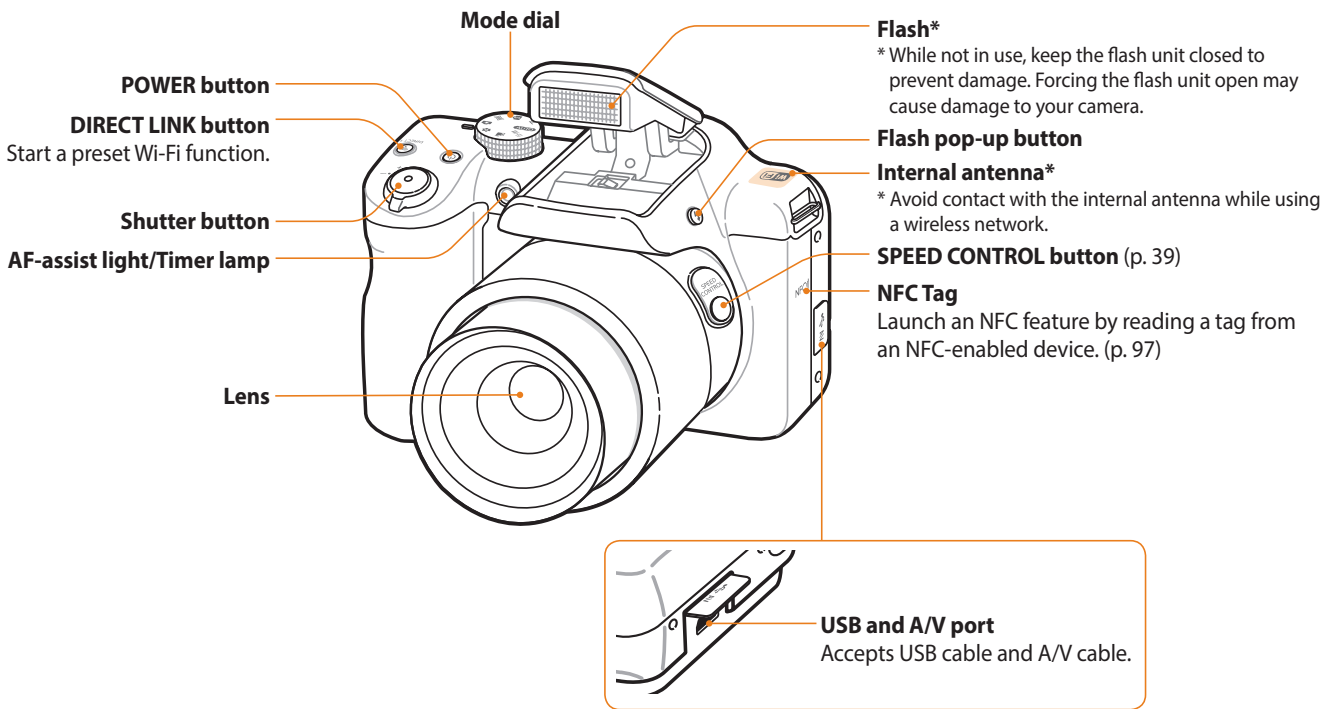

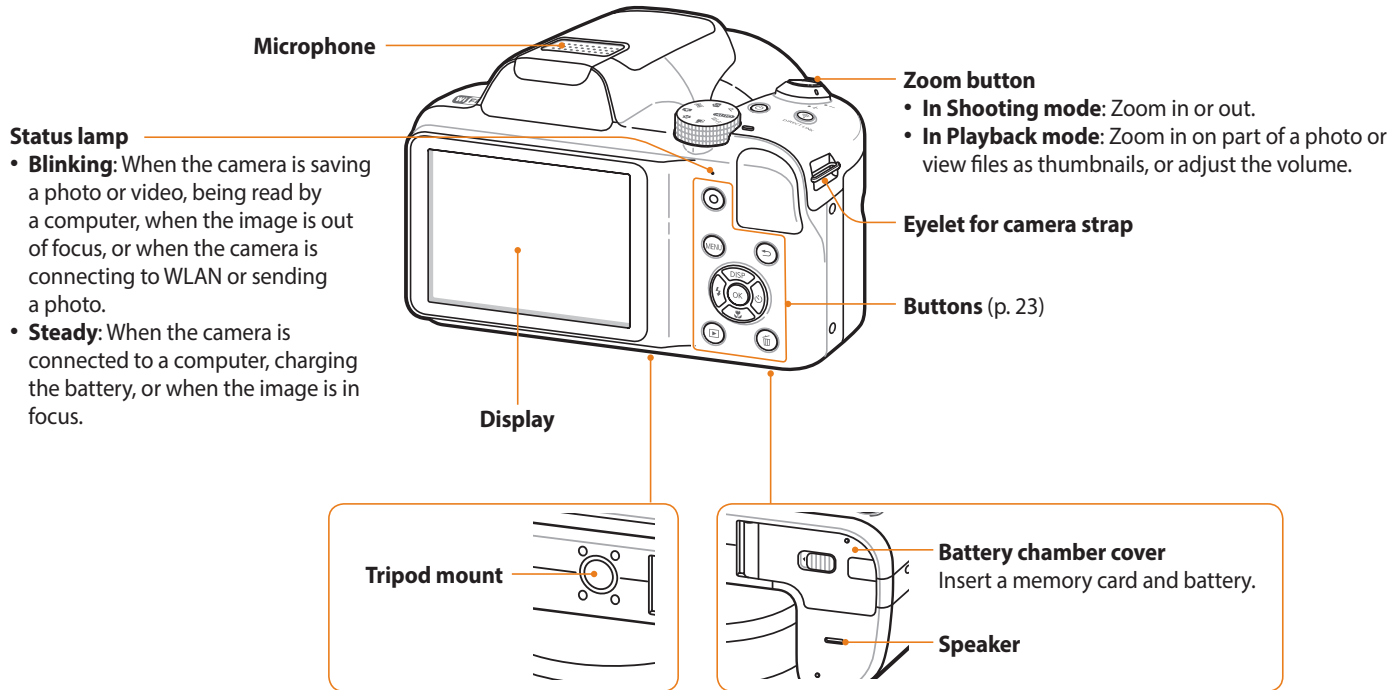



Camera layout

Before you start, familiarize yourself with your camera's parts and their functions.





Buttons

Button	Description		
	Start recording a video.		
	Access options or menus.		
	Go back.		
	Basic functions	Other functions	
	DISP	Change the display option.	Move up
		Change the macro option.	Move down
		Change the flash option.	Move left
		Change the timer option.	Move right
	Confirm the highlighted option or menu.		
	Enter Playback mode.		
	Delete files in Playback mode.		

Using the DIRECT LINK button

You can turn on the Wi-Fi feature conveniently with **[DIRECT LINK]**. Press **[DIRECT LINK]** to activate the Wi-Fi function that you have designated. Press **[DIRECT LINK]** again to return to the previous mode.

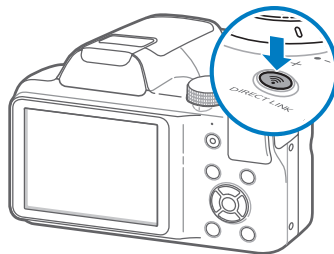
**Setting a DIRECT LINK button option**

You can select a Wi-Fi function to launch when you press **[DIRECT LINK]**.

- 1 Rotate the mode dial to .
- 2 Select **General** → **DIRECT LINK (Wi-Fi Button)**.
- 3 Select a Wi-Fi feature. (p. 114)

Attaching a strap

Attach a strap to carry your camera conveniently.

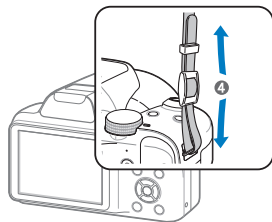
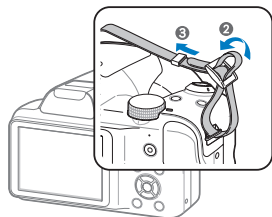
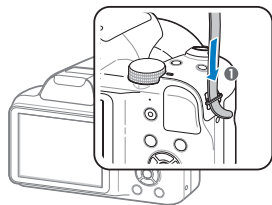

Attaching a lens cap

Attach a lens cap with a cap strap to protect the camera lens.

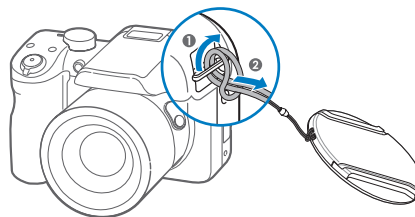
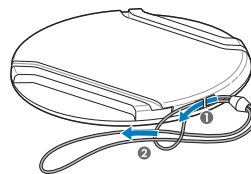

Inserting the battery and memory card

Learn how to insert the battery and an optional memory card into the camera.

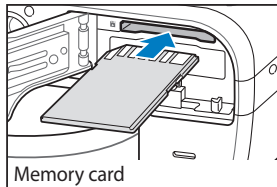
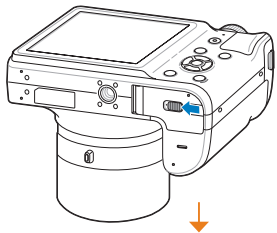

Insert a memory card with the gold-colored contacts facing up.

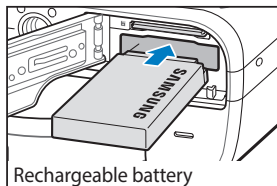

Insert the battery with the Samsung logo facing up.

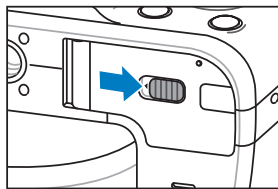
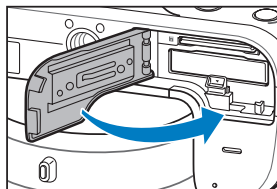

Removing the battery and memory card

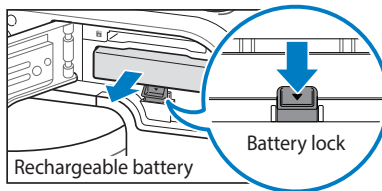

Slide the lock down to release the battery.

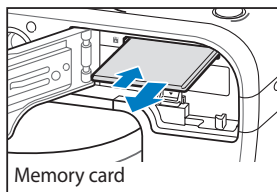

Push the card gently until it disengages from the camera, and then pull it out of the slot.

Using the memory card adapter

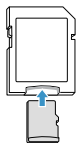

To use micro memory cards with this product, a PC, or a memory card reader, insert the card into an adapter.

Charging the battery and turning on your camera

Charging the battery

Before you use the camera for the first time, you must charge the battery. Plug the small end of the USB cable into your camera, and then plug the other end of the USB cable into the AC adapter.

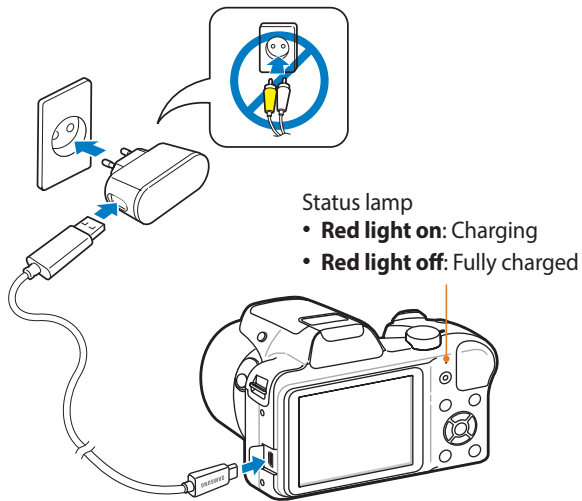

Use only the AC adapter and USB cable supplied with your camera. If you use another AC adapter (such as AD5055), the camera battery may not charge or work properly.

Turning on your camera

Press [ON] to turn your camera on or off.

- The initial setup screen appears when you turn on the camera for the first time. (p. 27)

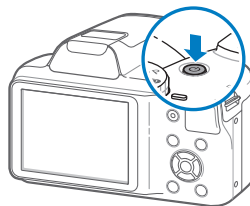

Turning on your camera in Playback mode

Press [▶]. The camera turns on and immediately accesses Playback mode.

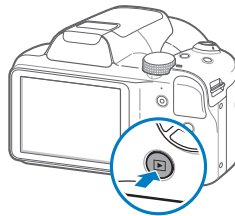

If you turn on your camera by pressing and holding [▶], the camera does not emit any sounds.

Performing the initial setup

When the initial setup screen appears, follow the steps below to configure the camera's basic settings. The default language is preset for the country or region where the camera is sold. You can change the language as desired by selecting **Language**.

- 1 Press [] to select **Time Zone**, and then press [] or [**OK**].
- 2 Press [/] to select a time zone, and then press [**OK**].

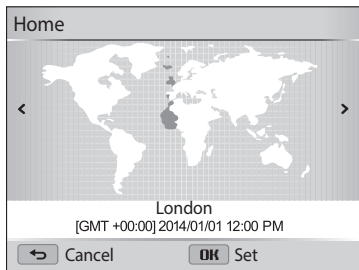

- 3 Press [] to select **Date/Time Set**, and then press [] or [**OK**].

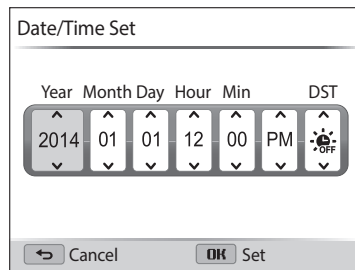

- 4 Press [/] to select an item.
- 5 Press [**DISP**/] to set the date, time, and daylight-saving time, and then press [**OK**].

6 Press [

7 Press [**DISP**/OK].

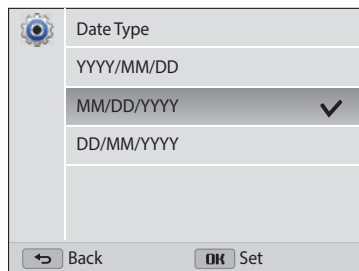

8 Press [Time Type, and then press [

9 Press [**DISP**/OK].

10 Press [



The screen may differ depending on the language you selected.

Learning icons

The camera displays icons for the mode and options you set. The icons flash yellow for a while if you change options.

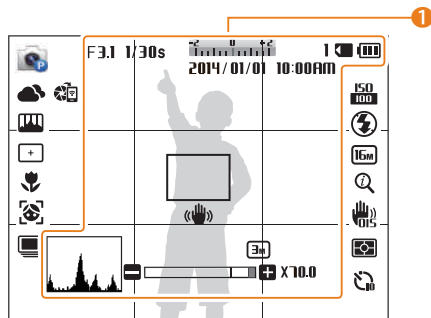

1 Shooting information

Icon	Description
F3.1	Aperture value
1/30s	Shutter speed
00:00:10	Available recording time
	Exposure value
1	Available number of photos
	Memory card inserted
	<ul style="list-style-type: none">: Fully charged: Partially charged: Empty (Recharge)

Icon	Description
2014/01/01	Current date
10:00AM	Current time
	Auto focus frame
	Camera shake
	Zoom indicator
	Photo resolution when the Intelli zoom is on
x 70.0	Zoom ratio
	Histogram

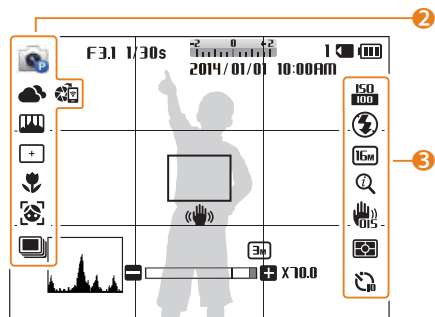

2 Shooting options (left)

Icon	Description
	Shooting mode
	White Balance
	Image Adjust (Sharpness, Contrast, and Saturation)
	Focus Area
	Focus
	Face Detection
	Burst option
	AutoShare On

3 Shooting options (right)

Icon	Description
	ISO sensitivity
	Video resolution
	Flash
	Frame Rate (per second)
	Photo resolution
	Zoom Mute
	Intelli zoom on
	Optical Image Stabilization (OIS)
	Metering
	Timer

Using the Mode screen

Use the mode dial to select a shooting mode or function. Rotate the mode dial to a desired mode. You can also select an icon on the Mode screen in some modes.

Selecting a Mode Screen



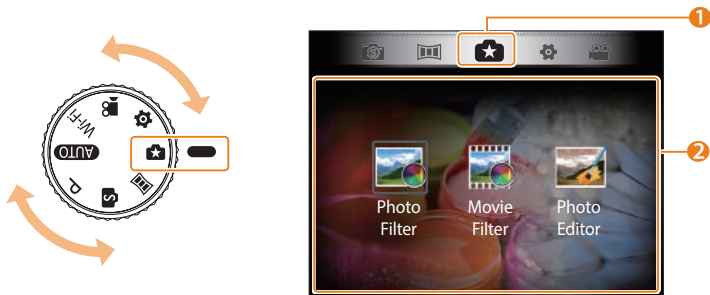









In Shooting or Playback mode, rotate the mode dial to display a Mode Screen. You can select an icon on the Mode screen in Magic Plus mode.









▲ For example: When you select **Photo Filter** in Magic Plus mode.

No.	Description
1	Current Mode screen • Rotate the mode dial to go to another mode screen.
2	Mode icons • Press [DISP/🌸/🔋/🌙] to scroll to a desired mode, and then press [OK] to access the mode.

Icons on the Mode screen

Mode	Icon	Description
		Smart Auto: Capture a photo with a scene mode selected automatically by the camera. (p. 44)
		Program: Capture a photo with settings you have adjusted manually. (p. 46)
		Smart: Capture a photo with options preset for a specific scene. (p. 47)
		Panorama: Capture and combine a series of photos to create a panoramic image. (p. 48)
		Photo Filter: Capture a photo with various filter effects. (p. 50)
		Movie Filter: Record a video with various filter effects. (p. 51)
		Photo Editor: Edit photos with various effects. (p. 83)
		Settings: Adjust settings to match your preferences. (p. 110)

Mode	Icon	Description
		Movie: Customize settings to record a video. (p. 52)
		MobileLink: Send photos or videos to a smart phone. (p. 99)
		Remote Viewfinder: Use a smart phone as a remote shutter release and see a preview of an image from your camera on your smart phone. (p. 100)
Wi-Fi		Email: Send photos or videos stored on the camera via email. (p. 102)
		SNS & Cloud: Upload photos or videos to file sharing services. (p. 105)
		Samsung Link: View files on devices that support Samsung Link. (p. 107)

Selecting options or menus

To select an option or a menu, press [MENU], and then press [DISP/⬆️/⚡/⌚] or [OK].

1 In Shooting or Playback mode, press [MENU].

2 Select an option or a menu.

- To move up or down, press [DISP] or [⬆️].
- To move left or right, press [⚡] or [⌚].

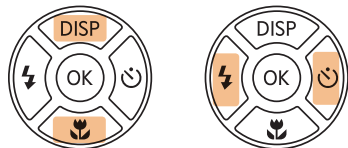

3 Press [OK] to confirm the highlighted option or menu.

Going back to the previous menu

Press [↶] to go back to the previous menu.



Half-press [Shutter] to return to Shooting mode.

For example, to select a White Balance option in Program mode:

- 1 Rotate the mode dial to **P**.

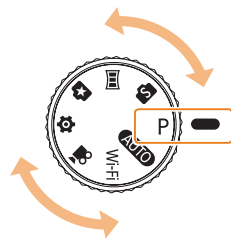

- 2 Press **[MENU]**.

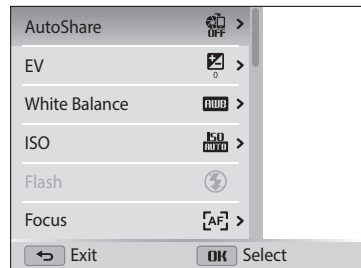

- 3 Press **[DISP/√]** to select **White Balance**, and then press **[☺]** or **[OK]**.
- 4 Press **[⚡/☺]** to select a White Balance option.

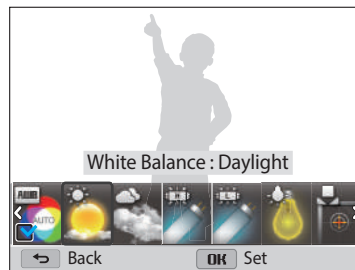

- 5 Press **[OK]** to save your settings.

Setting the display and sound

Learn how to change the basic display information and sound settings.

Setting the display type

You can select a display type for the Shooting or Playback mode. Each type displays different shooting or playback information. See the table below.

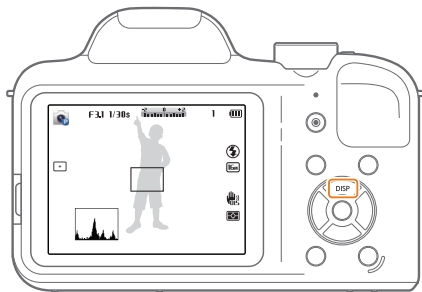

Press **[DISP]** repeatedly to change the display type.

Mode	Display type
Shooting	• Hide all information about shooting options.
	• Show all information about shooting options.
	• Show all information about shooting options and a histogram.
Playback	• Hide all information about the current file.
	• Hide all information about the current file except basic information.
	• Show all information about the current file.

About histograms

A histogram is a graph that illustrates how light is distributed in your photo. If the histogram has a high peak on the left, the photo is underexposed and will appear dark. A peak on the right of the graph means that the photo is overexposed and will appear washed out. The height of the peaks means that the photo is overexposed and will appear washed out. The height of the peaks is related to color information. The more of a particular color, the taller the peak.



▲ Under-exposed

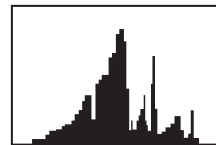

▲ Well-exposed



▲ Over-exposed

Setting the option display view

You can hide or show the option display appearing in some modes.

Press **[OK]** repeatedly.

- Hide the option display.
- Show the option display.

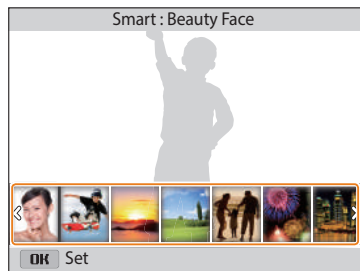

Option display

▲ For example, in **[S]** mode

Setting the sound

Turn the sound your camera emits when you perform functions on or off.

- 1 Rotate the mode dial to **[G]**.
- 2 Select **Sound** → **Beep Sound**.
- 3 Select an option.

Option	Description
Off	The camera does not emit any sounds.
On	The camera emits sounds.

Capturing photos

Learn how to capture photos easily and quickly in Smart Auto mode.

- 1 Rotate the mode dial to **AUTO**.

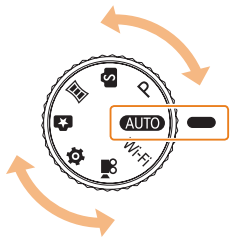

- 2 Align your subject in the frame.

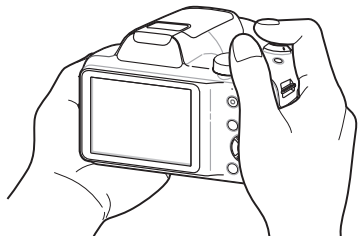

- 3 Half-press [**Shutter**] to focus.
 - A green frame means the subject is in focus.
 - A red frame means the subject is out of focus.

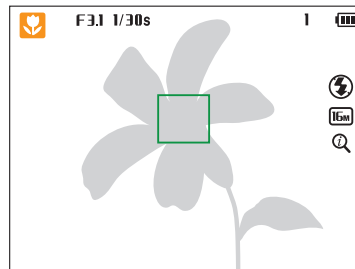

- 4 Press [**Shutter**] to capture a photo.
- 5 Press [**▶**] to view the captured photo.
 - To delete the photo, press [**🗑**], and then select **Yes**.
- 6 Press [**▶**] to return to Shooting mode.



See page 41 for tips to get clearer photos.

Zooming

You can capture close-up photos by adjusting the zoom.

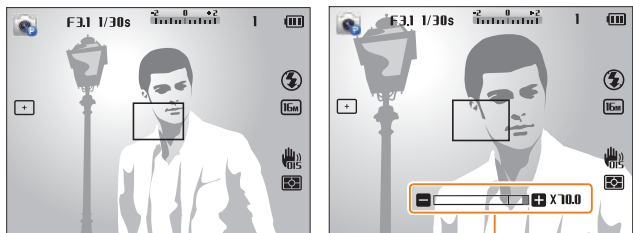

Zoom ratio

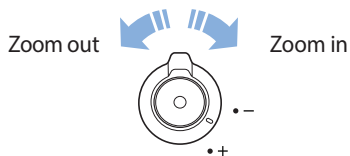

When you rotate the zoom button, the zoom ratio shown on the screen may change inconsistently.

Digital zoom P S

Digital zoom is supported by default in Shooting mode. If you zoom in on a subject in Shooting mode and the zoom indicator is in the digital range, your camera is using Digital zoom. By using both the 35X Optical zoom and 2X Digital zoom, you can zoom in up to 70 times.

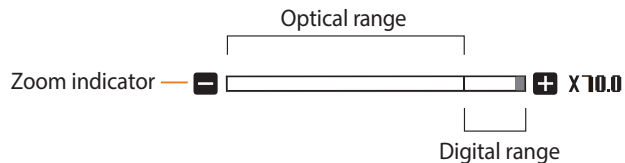

- Digital zoom is not available with the Tracking AF option or Face Detection options.
- If you capture a photo with Digital zoom, the photo quality may be lower than normal.

Intelli zoom AUTO P

If the zoom indicator is in the Intelli range, your camera is using Intelli zoom. Photo resolution varies according to the zoom rate if you use Intelli zoom. By using both Optical zoom and Intelli zoom, you can zoom in up to 70 times.

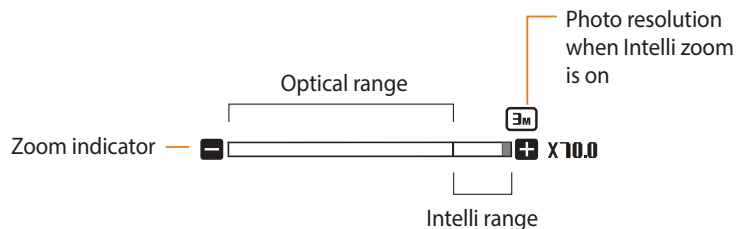

- Depending on the shooting options you selected, Intelli zoom is not available.
- Intelli zoom helps you capture a photo with less quality deterioration than Digital zoom. However, the photo quality may be lower than when you use Optical zoom.
- Intelli zoom is available only when you set a 4:3 resolution ratio. If you set another resolution ratio with Intelli zoom on, Intelli zoom will be turned off automatically.
- Intelli zoom is always on in AUTO mode.

Setting Intelli zoom P

- 1 In Shooting mode, press **[MENU]**.
- 2 Select **Intelli Zoom**.
- 3 Select an option.

Icon	Description
	Off: The Intelli zoom is deactivated.
	On: The Intelli zoom is activated.

Changing the zoom speed

When you use the zoom button with **[SPEED CONTROL]**, the speed of the zoom is changed.

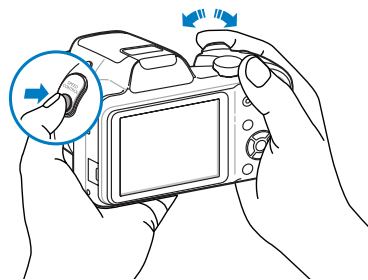

- **Photo recording mode:** the zoom function works faster.
- **Video recording mode:** the zoom function works slower.

Reducing camera shake (OIS) P

In Shooting mode, you can set either the Optical Image Stabilizer (OIS) or the Dual Image Stabilizer (Dual IS) to reduce or eliminate picture blurriness from camera shake.

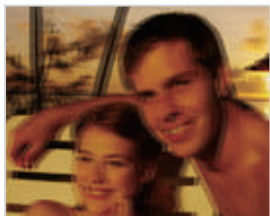

▲ Before correction



▲ After correction

1 In Shooting mode, press **[MENU]**.

2 Select **OIS**.

3 Select an option.

Icon	Description
	Off: OIS is deactivated.
	On: OIS is activated.
	Dual IS: The Dual Image Stabilizer (Dual IS) is activated.



- OIS may not function properly when:
 - you move your camera to follow a moving subject
 - you use Digital zoom
 - there is too much camera shake
 - the shutter speed is slow (for example, when you capture night scenes)
 - you capture a close-up shot
- If you use the OIS function with a tripod, your images may be blurred by the vibration of the OIS sensor. Deactivate the OIS function when you use a tripod.
- If the camera is hit or dropped, the display will be blurry. If this occurs, turn off the camera, and then turn it on again.

Tips for getting a clearer photo



Holding your camera correctly

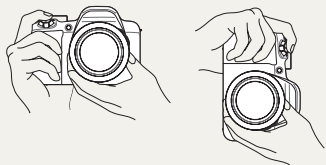

Ensure nothing is blocking the lens, flash, or microphone.



Half-pressing the shutter button

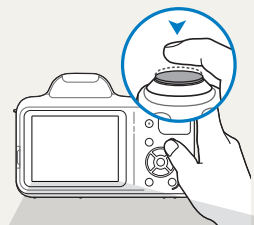

Half-press [**Shutter**] and adjust the focus. The camera adjusts the focus and exposure automatically.

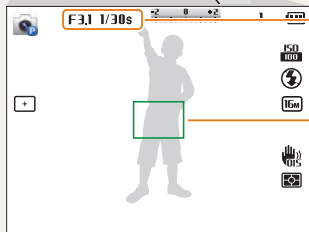

The camera sets the aperture value and shutter speed automatically.

Focus frame

- Press [**Shutter**] to capture the photo if the focus frame appears in green.
- Change the composition and half-press [**Shutter**] again if the focus frame appears in red.



Reducing camera shake



- Set the Optical Image Stabilization option to reduce camera shake digitally. (p. 40)
- Set the Dual IS option to reduce camera shake both optically and digitally. (p. 40)



When (Ⓜ) is displayed

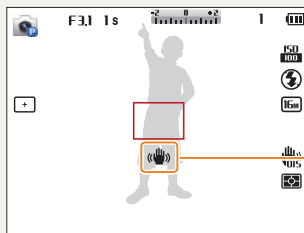

Camera shake

When you shoot in the dark, avoid setting the flash option to **Slow Sync** or **Off**. The aperture remains open longer and it may be harder to hold the camera steady long enough to capture a clear photo.

- Use a tripod or set the flash option to **Fill in**. (p. 58)
- Set ISO sensitivity options. (p. 59)



Preventing your subject from being out of focus

It may be difficult to get your subject in focus when:

- there is little contrast between the subject and background (for example, when your subject is wearing clothing that is similar in color to the background)
- the light source behind the subject is too bright
- the subject is shiny or reflective
- the subject includes horizontal patterns, such as blinds
- the subject is not positioned in the center of the frame



Using the focus lock

Half-press **[Shutter]** to focus. When the subject is in focus, you can reposition the frame to change the composition. When you are ready, press **[Shutter]** to capture your photo.

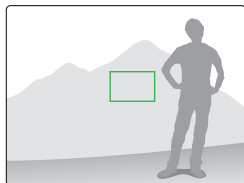
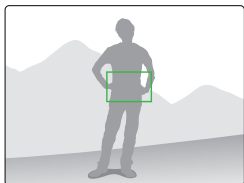

- When you capture photos in low light



Turn on the flash.
(p. 58)

- When subjects are moving rapidly

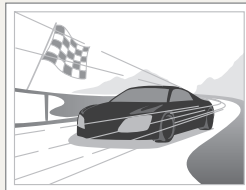

Use the Continuous
or Motion Capture
function. (p. 71)

Extended functions

Learn how to capture a photo and record a video by selecting a mode.

Using the Smart Auto mode	44	Using the Magic Plus mode	50
Using the Program mode	46	Using the Photo Filter mode	50
Using the Smart mode	47	Using the Movie Filter mode	51
Using the Panorama mode	48	Using the Movie mode	52

Using the Smart Auto mode



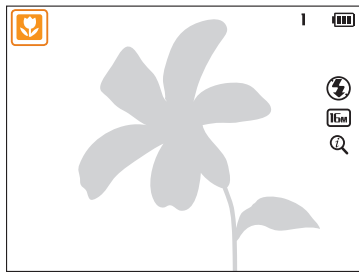

In Smart Auto mode, your camera automatically chooses the appropriate camera settings based on the type of scene it detects. The Smart Auto mode is helpful if you are not familiar with the camera settings for various scenes.

- 1 Rotate the mode dial to **AUTO**.
- 2 Align your subject in the frame.
 - The camera automatically selects a scene. An appropriate scene icon appears at the top left of the screen. The icons are listed below.



- 3 Half-press [**Shutter**] to focus.
- 4 Press [**Shutter**] to capture the photo.

Icon	Description
	Landscapes
	Scenes with bright white backgrounds
	Landscapes at night
	Portraits at night
	Landscapes with backlighting
	Portraits with backlighting
	Portraits
	Close-up photos of objects
	Close-up photos of text
	Sunsets
	Indoors, dark
	Partially lit
	Close-up with spot lighting
	Portraits with spot lighting

Icon	Description
	Blue skies
	Forested areas
	Close-up photos of colorful subjects
	Camera is stabilized on a tripod and the subject is not moving for a certain period of time. (when shooting in the dark)*
	Actively moving subjects*

* This icon appears next to the scene icon.



- If the camera does not recognize an appropriate scene mode, it uses the default settings for **AUTO** mode.
- Even if it detects a face, the camera may not select a portrait mode depending on the subject's position or lighting.
- The camera may not select the correct scene depending on the shooting conditions, such as camera shake, lighting, or distance to the subject.
- Even if you use a tripod, the camera may not detect the  mode if the subject is moving.
- The camera consumes more battery power, because it changes settings often to select appropriate scenes.



Using the Program mode

In Program mode, you can set most options, except the shutter speed and aperture value, which the camera sets automatically.

- 1 Rotate the mode dial to **P**.
- 2 Set the desired options.
 - For a list of options, refer to "Shooting options". (p. 53)
- 3 Align your subject in the frame, and then half-press [**Shutter**] to focus.
- 4 Press [**Shutter**] to capture the photo.

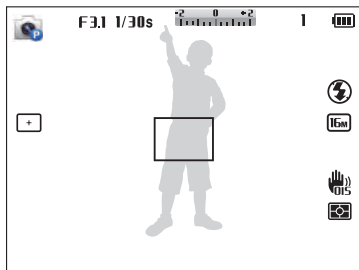

Using the Smart mode

In Smart mode, you can capture a photo with options that are preset for a specific scene.

- 1 Rotate the mode dial to **S**.
- 2 Select a scene.

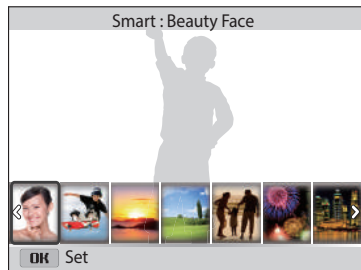

Option	Description
Beauty Face	Capture a portrait with options to hide facial imperfections.
Action Freeze	Capture subjects moving at high speed.
Sunset	Capture scenes at sunset, with natural-looking reds and yellows.
Landscape	Capture still-life scenes and landscapes.
Silhouette	Capture subjects as dark shapes against a light background.
Fireworks	Capture scenes with fireworks.

Option	Description
Night	Capture a photo with less image noise in low light conditions.
Macro	Capture small or close-up subjects.
Light Trace	Capture scenes with the light trailing in low-light conditions.

- 3 Align your subject in the frame, and then half-press [**Shutter**] to focus.
- 4 Press [**Shutter**] to capture the photo.

Using the Panorama mode

In Panorama mode, you can capture a wide panoramic scene in a single photo. Panorama mode captures and combines a series of photos to create a panoramic image.



▲ Shooting example

- 1 Rotate the mode dial to .
- 2 Align your subject in the frame, and then half-press **[Shutter]** to focus.
 - Align the camera with the far left or the far right, or very top or bottom, of the scene you want to capture.
- 3 Press and hold **[Shutter]** to start shooting.

- 4 With **[Shutter]** pressed, slowly move the camera in the direction that will let it capture the rest of the panorama.
 - Arrows pointing in the direction of motion are displayed, and the entire shooting image is displayed in the preview box.
 - When the viewfinder is aligned with the next scene, the camera captures the next photo automatically.

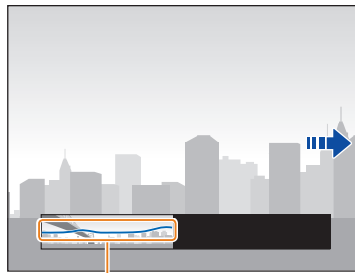

Shakiness: A flatter line represents less camera shake.

- 5 When you are finished, release **[Shutter]**.
 - When you have captured all the necessary shots, the camera combines them into one panoramic photo.



- For best results when capturing panoramic photos, avoid the following:
 - moving the camera too quickly or too slowly
 - moving the camera too little to capture the next image
 - moving the camera at irregular speeds
 - shaking the camera
 - shooting in dark places
 - capturing moving subjects nearby
 - shooting conditions where the brightness or color of light is changing
- Photos taken are automatically saved, and shooting is stopped under the following conditions:
 - if you change the shooting direction while shooting
 - if you move the camera too rapidly
 - if you don't move the camera
- Selecting Panorama mode will disable the digital and optical zoom functions. If you select Panorama mode while the lens is zoomed in, the camera automatically zooms out to the default position.
- Some shooting options are not available.
- The camera may stop shooting due to the shooting composition or movement within the scene.
- Your camera may not capture the last scene in its entirety if you stop moving the camera exactly where you want the scene to end. To capture the entire scene, move your camera slightly beyond the point where you want the scene to end.

Using the Magic Plus mode

Capture a photo or record a video with various effects.

Using the Photo Filter mode

Apply various filter effects to your photos to create unique images.



Miniature





Vignetting



Fish-eye



Classic

- 1 Rotate the mode dial to .
- 2 Select .
- 3 Select an effect.

Option	Description
Miniature	Apply a tilt-shift effect to make the subject appear in miniature. (The top and bottom of the photo will be blurred.)
Vignetting	Apply the retro-looking colors, high contrast, and strong vignette effect of Lomo cameras.
Fish-eye	Distort close objects to imitate the visual effect of a fisheye lens.
Classic	Apply a black and white effect.
Retro	Apply a sepia tone effect.
Cross Filter	Add lines that radiate outward from bright objects to imitate the visual effect of a cross filter.



- 4 Align your subject in the frame, and then half-press [**Shutter**] to focus.
- 5 Press [**Shutter**] to capture a photo.





- Depending on the option you select, the resolution may change to  or less automatically.
- To apply filter effects to saved photos, press [**MENU**], and then select **Open Image** → a desired image. The camera will save edited photos as new files.

Using the Movie Filter mode

Apply various filter effects to your videos to create unique images.

- 1 Rotate the mode dial to .
- 2 Select .
- 3 Select an effect.

Option	Description
Miniature	Apply a tilt-shift effect to make the subject appear in miniature. (The top and bottom of the photo will be blurred.)
Vignetting	Apply the retro-looking colors, high contrast, and strong vignette effect of Lomo cameras.
Fish-eye	Distort close objects to imitate the visual effect of a fisheye lens.
Classic	Apply a black and white effect.
Retro	Apply a sepia tone effect.
Palette Effect 1	Create a vivid look with sharp contrast and strong color.
Palette Effect 2	Make scenes clean and clear.
Palette Effect 3	Apply a soft brown tone.
Palette Effect 4	Create a cold and monotone effect.

- 4 Press  (Video recording) or [**Shutter**] to start recording.
- 5 Press  (Video recording) or [**Shutter**] again to stop recording.





- If you select **Miniature**, playback speed will increase.
- If you select **Miniature**, you cannot record sound in the video.
- Depending on the option you select, the recording resolution may change to **VGA** or less automatically.

Using the Movie mode



In Movie mode, you can customize settings to record HD (1280 X 720) videos of up to 20 minutes in length. The camera saves recorded videos as MP4 (H.264) files.



- MP4 (H.264) is a high-compression video format established by the international standards organizations ISO-IEC and ITU-T.
- If you use memory cards with slow write speeds, the camera may not save videos properly. Video recordings may be corrupted or fail to play back correctly.
- Memory cards with slow write speeds will not support high-resolution videos. To record high-resolution videos, use memory cards with faster write speeds.
- If you use the zoom function when recording a video, the camera may record the noise of the zoom operating. Use the Zoom Mute function not to record zoom noise. (p. 73)

- 1 Rotate the mode dial to .
- 2 Set desired options.
 - For a list of options, refer to "Shooting options". (p. 53)
- 3 Press  (Video recording) or [**Shutter**] to start recording.
- 4 Press  (Video recording) or [**Shutter**] again to stop recording.



You can start recording a video in some modes by pressing  (Video recording) without having to rotate the mode dial to .

Pause recording

The camera allows you to temporarily pause a video while recording. With this function, you can record separate scenes as a single video.

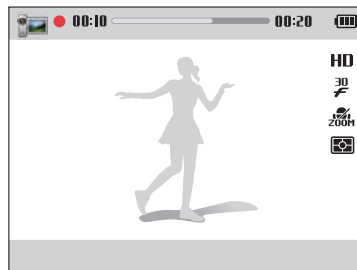

- Press [**OK**] to pause while recording.
- Press [**OK**] to resume.

Shooting options

Learn how to set the options in Shooting mode.

Selecting a resolution and quality	54	Capturing a self portrait shot	64
Selecting a resolution	54	Capturing a smile shot	65
Setting the photo quality	55	Detecting eye blinking	65
Using the timer	56	Tips for detecting faces	66
Shooting in the dark	57	Adjusting brightness and color	67
Preventing red-eye	57	Adjusting the exposure manually (EV)	67
How to use the flash	57	Compensating for backlighting (ACB)	68
Using the flash	58	Changing the metering option	68
Adjusting the ISO sensitivity	59	Selecting a White Balance setting	69
Changing the camera's focus	60	Using burst modes	
Using macro	60	(continuous, motion capture, AEB)	71
Changing the focus option	60	Adjusting images	72
Adjusting the focus area	61	Reducing the sound of the zoom	73
Using Face Detection	64		
Detecting faces	64		

Selecting a resolution and quality

Learn how to change the image resolution and quality settings.









Selecting a resolution

As you increase the resolution, your photo or video will include more pixels, so it can be printed on larger paper or displayed on a larger screen. When you use a high resolution, the file size will also increase.

Setting the photo resolution

AUTO P S ★

- 1 In Shooting mode, press [MENU].
- 2 Select **Photo Size**.
- 3 Select an option.

Icon	Description
	4608 X 3456: Print on A1 paper.
	4608 X 3072: Print on A1 paper in wide ratio (3:2).
	4608 X 2592: Print on A1 paper in panorama ratio (16:9) or play back on an HDTV.
	3648 X 2736: Print on A2 paper.
	2832 X 2832: Print on A3 paper in 1:1 ratio.
	2592 X 1944: Print on A4 paper.
	1984 X 1488: Print on A5 paper.
	1920 X 1080: Print on A5 paper in panorama ratio (16:9) or play back on an HDTV.
	1024 X 768: Attach to an email.

Setting the video resolution

AUTO P S   



- 1 In Shooting mode, press [MENU].
- 2 Select **Movie Size**.
- 3 Select an option.

Icon	Description
HD	1280 X 720: HD files to play back on an HDTV.
VGA	640 X 480: SD files to play back on an analog TV.
QVGA	320 X 240: Post on a web page.
 240 WEB	For Sharing: Post on a website using the wireless network (30 seconds maximum).

Setting the photo quality P

Set the photo quality settings. Higher image quality settings will result in larger file sizes. The camera compresses and saves the photos you capture in the JPEG format.

- 1 In Shooting mode, press **[MENU]**.
- 2 Select **Quality**.
- 3 Select an option.

Icon	Description
	Super Fine: Capture photos in super high quality.
	Fine: Capture photos in high quality.
	Normal: Capture photos in normal quality.

Using the timer

AUTO P S ★ 📷

Learn how to set the timer to delay shooting.

1 In Shooting mode, press [⏸].

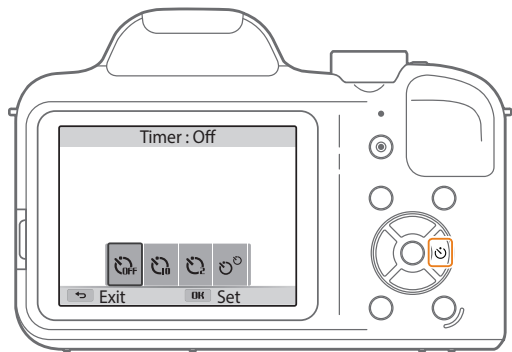

2 Select an option.

Icon	Description
	Off: The timer is not active.
	10 Sec: Capture a photo after a 10-second delay.
	2 Sec: Capture a photo after a 2-second delay.
	Double: Capture one photo after a 10-second delay and another photo after a 2-second delay.

Available options may differ depending on the shooting conditions.

3 Press [**Shutter**] to start the timer.

- The AF-assist light/timer lamp blinks. The camera will automatically capture a photo after the specified time has elapsed.



- Press [**Shutter**] or [⏸] to cancel the timer.
- Depending on the Face Detection options you selected, the timer function may not be available.
- Timer options are not available if you set burst options.
- In some modes, you can also set the timer option by pressing [MENU], and then selecting **Timer**.

Shooting in the dark

Learn how to capture photos at night or in low light conditions.

Preventing red-eye P

If the flash fires when you capture a photo of a person in the dark, a red glow may appear in the person's eyes. To prevent this, select **Red-eye** or **Red-eye Fix**. Refer to flash options in "Using the flash." (p. 58)



▲ Before correction



▲ After correction

How to use the flash

Press the flash pop-up button to pop the flash up. When the flash unit pops up, the flash fires in accordance with the option you have selected. If you select **Off**, the flash does not fire even when it is popped up.

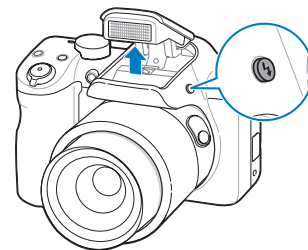

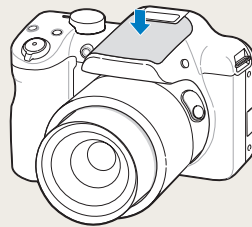

- While not in use, keep the flash unit closed to prevent damage.
- Forcing open the flash unit may cause damage to your camera.







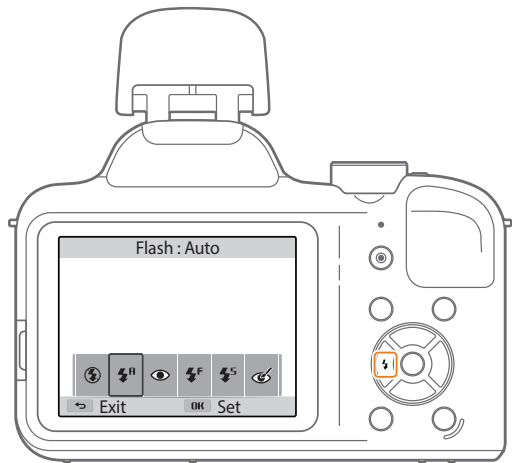

Using the flash AUTO P S ★

Use the flash when you capture photos in the dark or when you need more light in your photos.

- 1 Press [] to pop the flash up when it is need.
- 2 In Shooting mode, press [].



3 Select an option.

Icon	Description
	<p>Off:</p> <ul style="list-style-type: none"> The flash will not fire. The camera will display the shake warning  when you are shooting in low light.
	<p>Auto: The flash will fire automatically when the subject or background is dark.</p>
	<p>Red-eye:</p> <ul style="list-style-type: none"> The flash will fire twice when the subject or background is dark to reduce the red-eye effect. There is an interval between the 2 bursts of the flash. Do not move until the flash fires a second time.
	<p>Fill in:</p> <ul style="list-style-type: none"> The flash always fires. The camera automatically adjusts the intensity of the flash.
	<p>Slow Sync:</p> <ul style="list-style-type: none"> The flash fires and the shutter stays open longer. This option is recommended when you want to capture more ambient light to reveal more details in the background. Use a tripod to prevent your photos from blurring. The camera will display the shake warning  when you are shooting in low light.

Icon	Description
	<p>Red-eye Fix:</p> <ul style="list-style-type: none"> • The flash fires twice when the subject or background is dark. The camera corrects red-eye through its advanced software analysis. • There is an interval between the 2 bursts of the flash. Do not move until the flash fires a second time.

Available options may differ depending on the shooting conditions.

- Flash options are not available if you set burst options or select **Self-Portrait** or **Blink Detection**.
- Make sure that your subjects are within the recommended distance from the flash. (p. 132)
- If light from the flash is reflected or there is a substantial amount of dust in the air, tiny spots may appear in your photo.
- In some modes, you can also set the flash option by pressing [MENU], and then selecting **Flash**.

Adjusting the ISO sensitivity P

The ISO sensitivity is the measure of a film's sensitivity to light as defined by the International Organization for Standardization (ISO). The higher ISO sensitivity you select, the more sensitive to light your camera becomes. Use a higher ISO sensitivity to capture better photos and reduce camera shake when not using the flash.

- 1 In Shooting mode, press [MENU].
- 2 Select **ISO**.
- 3 Select an option.
 - Select $\frac{\text{ISO}}{\text{1000}}$ to use an appropriate ISO sensitivity based on the brightness of the subject and lighting.

- Higher ISO sensitivities may result in more image noise.
- If you set the ISO option to $\frac{\text{ISO}}{\text{8200}}$, the resolution may change to [3M] or smaller.

Changing the camera's focus

Learn how to adjust the camera's focus to suit the subject and the shooting conditions.

Using macro P

Use macro to capture close-up photos of subjects, such as flowers or insects. (Refer to "Changing the focus option".)



- Try to hold the camera firmly to prevent blurry photos.
- Turn off the flash if the distance to the subject is less than 40 cm.

Changing the focus option P

You can get clearer photos by selecting an appropriate focus option according to the distance between the camera and subjects.

1 In Shooting mode, press [].

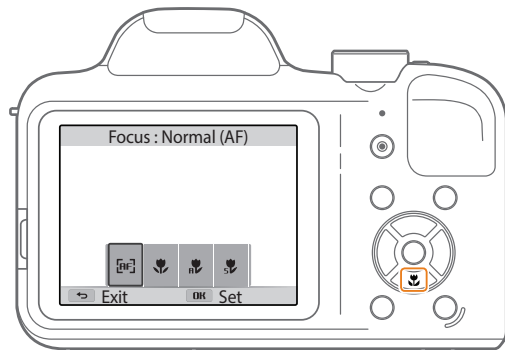

2 Select an option.

Icon	Description
	Normal (AF): Focus on a subject farther than 31 in. (80 cm) away. Farther than 59 in. (150 cm) away when you use the zoom.
	Macro: Focus on a subject that is 4-31 in. (10-80 cm) from the camera. 59-138 in. (150-350 cm) when you use the zoom.
	Auto Macro: <ul style="list-style-type: none"> Focus on a subject farther than 0.4 in. (1 cm) away. Farther than 59 in. (150 cm) away when you use the zoom. It is set automatically in some shooting modes.
	Super Macro: Focus on a subject that is 0.4 in. (1 cm) from the camera.

Available options may differ depending on the shooting conditions.



In some modes, you can also set the focus option by pressing [MENU], and then selecting **Focus**.

Adjusting the focus area P

You can get clearer photos by selecting an appropriate focus area according to your subject's location in the scene.

- 1 In Shooting mode, press [MENU].
- 2 Select **Focus Area**.
- 3 Select an option.

Icon	Description
	Center AF: Focus on the center of the frame (suitable when subjects are located at or near the center).
	Multi AF: Focus on one or more of 9 possible areas.
	Selection AF: Focus on the area that you select. (p. 62)
	Tracking AF: Focus on and track the subject. (p. 62)

Available shooting options may differ depending on the shooting conditions.

Focusing on a selected area

You can focus on an area that you have selected.

- 1 In Shooting mode, press [MENU].
- 2 Select **Focus Area** → **Selection AF**.
- 3 Press [OK], and then press [DISP/🌸/🔋/🌞] to move the frame to a desired area.

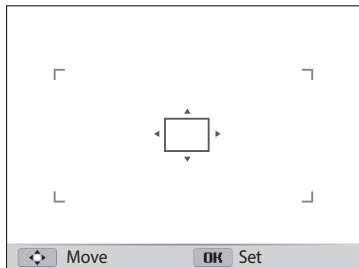

- 4 Press [OK].
- 5 Press [Shutter] to capture the photo.
 - Press [OK] to change the focus area.



If you use this function, you cannot set Face Detection options, Timer options, and Intelli zoom.

Using tracking auto focus

Tracking AF allows you to track and auto focus on your subject, even when you are moving.

- 1 In Shooting mode, press [MENU].
- 2 Select **Focus Area** → **Tracking AF**.
- 3 Focus on the subject you want to track, and then press [OK].
 - A focus frame appears on the subject and follows the subject as you move the camera.

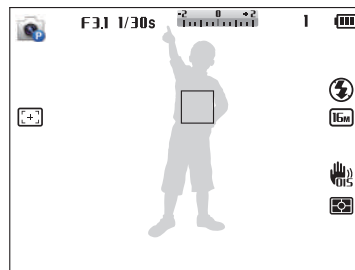

- The white frame means that your camera is tracking the subject.
- When you half-press [Shutter], the green frame means that your subject is in focus.
- The red frame means that your camera failed to focus.

- 4 Press [Shutter] to capture the photo.



- If you do not select a focus area, the focus frame will appear in the center of the screen.
- Tracking a subject may fail when:
 - the subject is too small
 - the subject moves excessively
 - the subject is backlit or you are shooting in a dark place
 - colors or patterns on the subject and the background are the same
 - the subject includes horizontal patterns, such as blinds
 - the camera shakes excessively
- When tracking fails, the feature will be reset.
- If the camera fails to track the subject, you must reselect the subject to track.
- If the camera fails to focus, the focus frame will change to red and the focus will be reset.
- If you use this function, you cannot set Face Detection options, Timer options, Drive options and Intelli zoom.

Using Face Detection P

If you use Face Detection options, your camera can automatically detect a human face. When you focus on a human face, the camera adjusts the exposure automatically. Use **Blink Detection** to detect closed eyes or **Smile Shot** to capture a smiling face.

Detecting faces

Your camera automatically detects up to 10 human faces in one scene.

- 1 In Shooting mode, press **[MENU]**.
- 2 Select **Face Detection** → **Normal**.

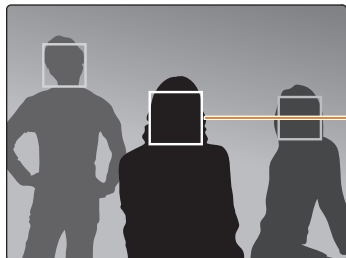

The face nearest the camera or nearest the center of the scene appears in a white focus frame and the rest of the faces appear in gray focus frames.



The closer you are to the subjects, the quicker your camera will detect faces.

Capturing a self portrait shot

Capture photos of yourself. The camera sets the focus distance to close-up, and then emits a beep when ready.

- 1 In Shooting mode, press **[MENU]**.
- 2 Select **Face Detection** → **Self-Portrait**.
- 3 Compose your shot with the lens facing you.
- 4 When you hear a quick beep, press **[Shutter]**.



When faces are located in the center, the camera beeps rapidly.



If you turn Volume off in the sound settings, the camera will not emit a beep. (p. 111)

Capturing a smile shot

The camera automatically releases the shutter when it detects a smiling face.

- 1 In Shooting mode, press [MENU].
- 2 Select **Face Detection** → **Smile Shot**.
- 3 Compose your shot.
 - The camera automatically releases the shutter when it detects a smiling face.

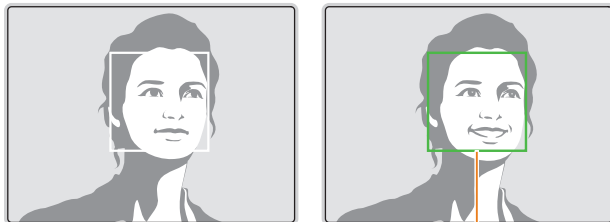

When your subject smiles broadly, your camera can detect the smile more easily.

Detecting eye blinking

If your camera detects closed eyes, it will automatically capture 2 photos in succession.

- 1 In Shooting mode, press [MENU].
- 2 Select **Face Detection** → **Blink Detection**.

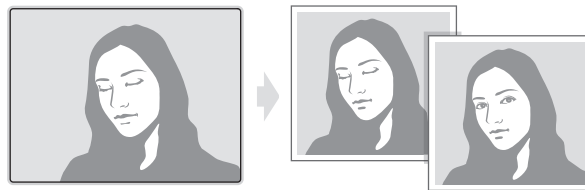

Tips for detecting faces

- When your camera detects a face, it tracks the detected face automatically.
- Face Detection may not be effective when:
 - the subject is far from the camera
 - it is too bright or too dark
 - the subject is not facing the camera
 - the subject is wearing sunglasses or a mask
 - the subject's facial expression changes drastically
 - the subject is backlit or the lighting conditions are unstable
- Face Detection is not available when you set the Selection AF or Tracking AF.
- When you set Face Detection options, the AF area is automatically set to Multi AF.
- Depending on the Face Detection options you selected, some shooting options may not be available.
- Depending on the shooting options you selected, Face Detection options may not be available.

Adjusting brightness and color

Learn how to adjust the brightness and color for better image quality.

Adjusting the exposure manually (EV) P

Depending on the intensity of the ambient light, your photos may be too bright or dark. In these cases, you can adjust the exposure to get a better photo.



▲ Darker (-)



▲ Neutral (0)



▲ Brighter (+)

1 In Shooting mode, press [MENU].

2 Select **EV**.

3 Press [] to adjust the exposure.

- The photo will be brighter as the exposure value increases.

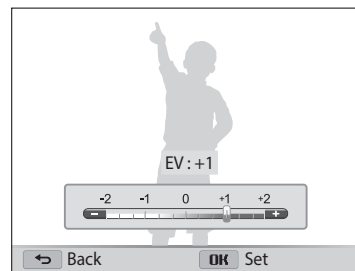

4 Press [OK] to save your settings.



- Once you adjust the exposure, the setting will be stored automatically. You may need to change the exposure value later to avoid overexposure or underexposure.
- If you cannot decide on an appropriate exposure, select the **AEB** (Auto Exposure Bracket) option. The camera will capture 3 consecutive photos, each with a different exposure: normal, underexposed, and overexposed. (p. 71)

Compensating for backlighting (ACB) P

When the light source is behind your subject or there is high contrast between your subject and the background, your subject is likely to appear dark in the photo. In this case, set the Auto Contrast Balance (ACB) option.



▲ Without ACB

▲ With ACB

- 1 In Shooting mode, press [MENU].
- 2 Select **ACB**.
- 3 Select an option.

Icon	Description
	Off: ACB (Auto Contrast Balance) is deactivated.
	On: ACB (Auto Contrast Balance) is activated.



- The ACB feature is always on in **AUTO** mode.
- The ACB feature is not available when you set burst options.

Changing the metering option P

The metering mode refers to the way in which a camera measures the quantity of light. The brightness and lighting of your photos will vary depending on the metering mode you select.

- 1 In Shooting mode, press [MENU].
- 2 Select **Metering**.
- 3 Select an option.

Icon	Description
	<p>Multi:</p> <ul style="list-style-type: none"> • Your camera divides the frame into several areas, and then measures the light intensity of each area. • Suitable for general photos.
	<p>Spot:</p> <ul style="list-style-type: none"> • Your camera measures only the light intensity at the very center of the frame. • If a subject is not in the center of the frame, your photo may be improperly exposed. • Suitable for a subject with backlighting.
	<p>Center-weighted:</p> <ul style="list-style-type: none"> • Your camera averages the meter reading of the entire frame with emphasis placed on the center. • Suitable for photos with subjects in the center of the frame.

Selecting a White Balance setting P

The color of your photo depends on the type and quality of the light source. If you want the color of your photo to be realistic, select a White Balance setting that is appropriate for the lighting conditions, such as Auto WB, Daylight, Cloudy, or Tungsten.



 Auto WB



 Daylight











 Cloudy



 Tungsten

- 1 In Shooting mode, press [MENU].
- 2 Select **White Balance**.
- 3 Select an option.

Icon	Description
	Auto WB: Automatically set the White Balance based on the lighting conditions.
	Daylight: For outdoor photos on a sunny day.
	Cloudy: For outdoor photos on a cloudy day or in shadows.
	Fluorescent_H: For shooting under a daylight fluorescent or 3-way fluorescent light.
	Fluorescent_L: For shooting under white fluorescent light.
	Tungsten: For shooting indoor photos under incandescent bulbs or halogen lamps.
	Custom Set: To use White Balance settings that you define. (p. 70)
	Color Temp.: To adjust the color temperature of the light source. (p. 70)

Defining your own White Balance

You can customize the White Balance by capturing a photo of a white surface, such as a piece of paper, under the lighting conditions in which you intend to capture a photo. The White Balance feature will help you to match the colors in your photo with the actual scene.

- 1 In Shooting mode, press [MENU].
- 2 Select **White Balance** → **Custom Set**.
- 3 Aim the lens at a piece of white paper, and then press [Shutter].

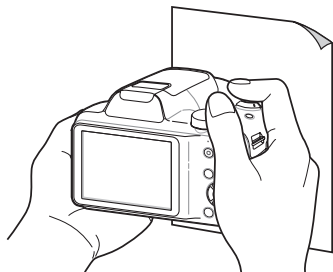

Adjusting color temperature

- 1 In Shooting mode, press [MENU].
- 2 Select **White Balance** → **Color Temp.**.
- 3 Press [⚡/☺] to adjust the color temperature to match your light source.
 - You can get a warmer photo with a higher value, and a cooler photo with a lower value.

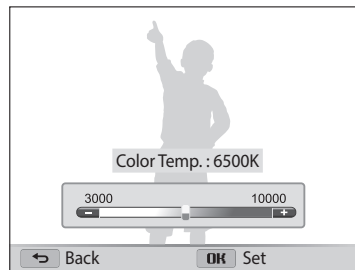



- 4 Press [OK] to save your settings.



Using burst modes (continuous, motion capture, AEB) P

It can be difficult to capture photos of fast-moving subjects or capture natural facial expressions and gestures of your subjects in photos. Also, it can be difficult to adjust the exposure correctly and select a proper light source. In these cases, select one of the burst modes.



- 1 In Shooting mode, press [MENU].
- 2 Select **Drive**.
- 3 Select an option.

Icon	Description
	Single: Capture a single photo.
	Continuous: <ul style="list-style-type: none">• While you are pressing [Shutter], the camera continuously captures photos.• The maximum number of photos depends on the capacity of your memory card.

Icon	Description
	Motion Capture: While you are pressing [Shutter], the camera captures VGA photos (5 photos per second; maximum of 30 photos).
	AEB: <ul style="list-style-type: none">• Capture 3 consecutive photos, each with a different exposure: normal, underexposed, and overexposed.• Use a tripod to prevent blurry photos.



- You can use the flash, timer, and ACB only when you select **Single**.
- When you select **Motion Capture**, your camera will set the resolution to **VGA** and set the ISO sensitivity to **Auto**.
- Depending on the Face Detection option you selected, some Burst options may not be available.

Adjusting images P

Adjust the sharpness, contrast, or saturation of your photos.

- 1 In Shooting mode, press [MENU].
- 2 Select **Image Adjust**.
- 3 Select an option.
 - Sharpness
 - Contrast
 - Saturation

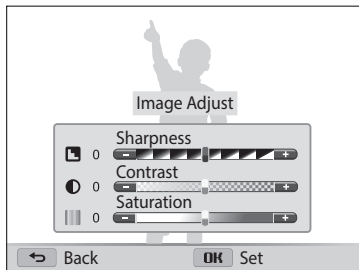

- 4 Press [**⚡/☺**] to adjust each value.

Sharpness	Description
-	Soften the edges on your photos (suitable for editing the photos on your computer).
+	Sharpen the edges to improve the clarity of your photos. This may also increase the noise in your photos.

Contrast	Description
-	Decrease the color and brightness.
+	Increase the color and brightness.

Saturation	Description
-	Decrease the saturation.
+	Increase the saturation.

- 5 Press [OK] to save your settings.





Select 0 if you do not want to apply any effects (suitable for printing).

Reducing the sound of the zoom

AUTO P S [] * []

When you use the zoom while recording videos, the camera can record the sound of the zoom. Use the Zoom Mute function not to record zoom noise.

- 1 In Shooting mode, press [MENU].
- 2 Select **Voice**.
- 3 Select an option.

Icon	Description
	Zoom Mute: The camera stops recording sound temporarily when you use the zoom.
	Off: Record a video without sound.
	On: Record a video with sound.



- Do not block the microphone when you use the Voice function.
- Recordings made with Voice may differ from actual sounds.

Playback/Editing

Learn how to play back photos or videos, and edit photos or videos. Also, learn how to connect your camera to your computer or TV.

Viewing photos or videos in Playback mode ...	75	Editing a video	87
Starting Playback mode	75	Trimming a video	87
Viewing photos	79	Capturing an image from video	87
Playing a video	82	Viewing files on a TV	88
Editing a photo	83	Transferring files to a computer	89
Resizing photos	83	Transferring files to your Windows OS	
Rotating a photo	83	computer	89
Applying Smart Filter effects	84	Transferring files to your Mac OS computer	90
Adjusting your photos	85	System Requirements	91

Viewing photos or videos in Playback mode

Learn how to play back photos or videos and how to manage files.

Starting Playback mode

View photos or play videos stored in your camera.

- 1 Press [▶].
 - The most recent file will be displayed.
 - If the camera is off, it will turn on and display the most recent file.
- 2 Press [⚡/📷] to scroll through files.
 - Press and hold [⚡/📷] to scroll through files quickly.



- You may not be able to edit or play back files that were captured with other cameras, due to unsupported sizes (image size, etc) or codecs. Use a computer or another device to edit or play back these files.
- Photos or videos captured in portrait orientation do not rotate automatically and are displayed in landscape orientation by the camera and other devices.

Photo file information

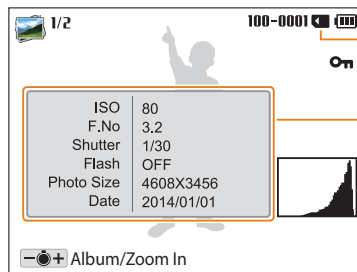

Memory in use

File Information

Histogram

Icon	Description
1/2	Current file/Total files
100-0001	Folder name–File name
On	Protected file



To display file information on the screen, press [DISP].

Video file information

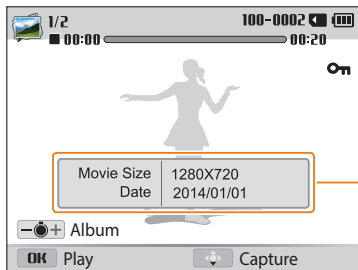

File Information

Icon	Description
1/2	Current file/Total files
100-0002	Folder name-File name
00:00	Current playback time
00:20	Video length
On	Protected file



To display file information on the screen, press [DISP].

Viewing files as thumbnails

Scan thumbnails of files.

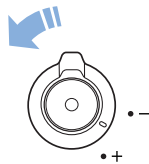

In Playback mode, rotate **[Zoom]** to the left to view thumbnails (12 at a time). Rotate **[Zoom]** to the left once more to display more thumbnails (24 at a time). Rotate **[Zoom]** to the right to return to the previous view.

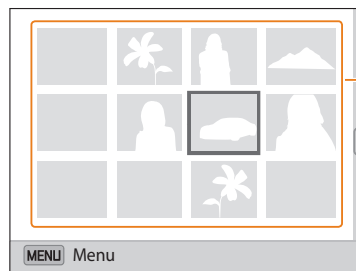

Move to the desired file, and then press **[OK]** to display it in full screen view.

Press **[DISP/👉/🔋/🌞]** to scroll through files.

Viewing files by category

View files by category, such as date or file type.

- 1 In Playback mode, rotate **[Zoom]** to the left.
- 2 Press **[MENU]**.
- 3 Select **Filter** → a category.

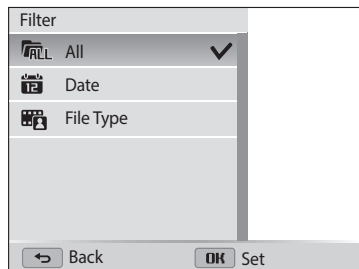

Icon	Description
	All: View files normally.
	Date: View files by the date they were saved.
	File Type: View files by the file type.

- 4 Scroll to a desired list, and then press **[OK]** to open the list.
- 5 Scroll to a desired file, and then press **[OK]** to view the file.
- 6 Rotate **[Zoom]** to the left to return to the previous view, and then press **[↵]**.



- If you change the category, it may take some time for the camera to reorganize files depending on the number of files.
- If you delete a category classified by **Date** or **File Type**, all files in the category will be deleted.

Protecting files

Protect a file from accidental deletion.

- 1 In Playback mode, select a file to protect.
- 2 Press [MENU], and then select **Protect** → **On**.
- 3 Repeat steps 1 and 2 to protect additional files.



You cannot delete, resize, or rotate a protected file.

Deleting files

Select files to delete in Playback mode.

Deleting a single file

You can select one file, and then delete it.

- 1 In Playback mode, select a file, and then press [🗑️].
- 2 When the pop-up message appears, select **Yes**.



You can also delete files in Playback mode by pressing [MENU], and then selecting **Delete** → **Delete** → **Yes**.

Deleting multiple files

You can select multiple files, and then delete them at once.

- 1 In Playback mode, press [🗑️].
 - When in thumbnails view, press [MENU], select **Delete** → **Select**, and then skip to step 3, or press [🗑️], select **Select**, and then skip to step 3.
- 2 When the pop-up message appears, select **Multiple Delete**.
- 3 Scroll to each file you want to delete, and then press [OK].
 - Press [OK] again to cancel your selection.
- 4 Press [🗑️].
- 5 When the pop-up message appears, select **Yes**.

Deleting all files

You can select all files, and then delete them at once.

- 1 In Playback mode, press [MENU].
 - When in thumbnails view, press [MENU], select **Delete** → **Delete All**, and then skip to step 3, or press [🗑️], select **Delete All**, and then skip to step 3.
- 2 Select **Delete** → **Delete All**.
- 3 When the pop-up message appears, select **Yes**.
 - All unprotected files are deleted.

Viewing photos

Enlarge part of a photo or view photos as a slide show.

Enlarging a photo

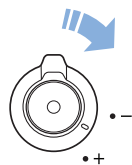

In Playback mode, rotate [Zoom] to the right to enlarge a portion of the photo. Rotate [Zoom] to the left to zoom out.

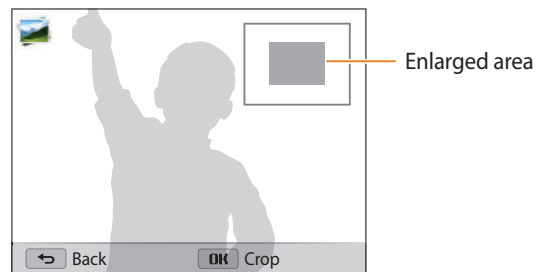

To	Description
Move the enlarged area	Press [DISP/🌿/⚡/🔄].
Trim the enlarged photo	Press [OK], and then select Yes . (The trimmed photo will be saved as a new file. The original photo is retained in its original form.)



When you view photos that were captured by another camera, the zoom ratio may differ.

Viewing panoramic photos

View photos captured in Panorama mode.

- In Playback mode, press [⚡/🔄] to scroll to a desired panoramic photo.
 - The entire panoramic photo appears on the screen.
- Press [OK].
 - The camera automatically scrolls through the photo from left to right for a horizontal panoramic photo and from top to bottom for a vertical panoramic photo. The camera then switches to Playback mode.
 - While playing back a panoramic photo, press [OK] to pause or resume from pausing.
 - After you have paused the playback of a panoramic photo, press [DISP/🌿/⚡/🔄] to move the photo horizontally or vertically, depending on the direction you moved when capturing the photo.
- Press [↩] to return to Playback mode.



The camera automatically scrolls through the panoramic photo only if the longest side of the photo is two or more times longer than the shortest side.

Playing a slide show

Apply effects and audio to a slide show of your photos. The slide show function does not work for videos.

- 1 In Playback mode, press [MENU].
- 2 Select **Slide Show Options**.
 - Skip to step 5 to start a slide show with no effects.
- 3 Select a slide show effect option.

* Default

Option	Description
Play Mode	Set whether or not to repeat the slide show. (One Play* , Repeat)
Interval	<ul style="list-style-type: none"> • Set the interval between photos. (1 sec*, 3 sec, 5 sec, 10 sec) • You must set the Effect option to Off to set the interval.
Music	Set background audio.
Effect	<ul style="list-style-type: none"> • Set a scene change effect between photos. (Off, Calm*, Relax, Lively, Sweet, Shine) • Select Off to cancel effects. • When you use the Effect option, the interval between photos will be set to 1 second.

- 4 Press [MENU] or [↵].
- 5 Select **Start Slide Show**.
- 6 View the slide show.
 - Press [OK] to pause the slide show.
 - Press [OK] again to resume the slide show.



- Press [↵] to stop the slide show and return to Playback mode.
- Rotate [Zoom] to the left or right to adjust the volume level.

Playing a video

In Playback mode, you can view a video, and then capture or trim parts of the playing video. You can save the captured or trimmed segments as new files.

- 1 In Playback mode, select a video, and then press [OK].
- 2 View the video.

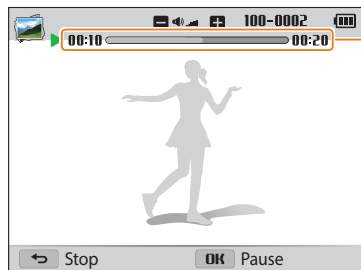

Current playback time/
Video length

To	Description
Scan backward	Press [⏮]. Each time you press [⏮], you change the scan speed in this order: 2X, 4X, 8X.
Pause or resume playback	Press [OK].
Scan forward	Press [⏭]. Each time you press [⏭], you change the scan speed in this order: 2X, 4X, 8X.
Adjust the volume level	Rotate [Zoom] to the left or right.



You can scan backwards or forwards or pause the video after at least 2 seconds have elapsed from the starting point.

Editing a photo

Learn how to edit photos.



- The camera will save edited photos as new files.
- When you edit photos, the camera will automatically convert them to a lower resolution. Photos that you rotate or resize manually are not automatically converted to a lower resolution.

Resizing photos

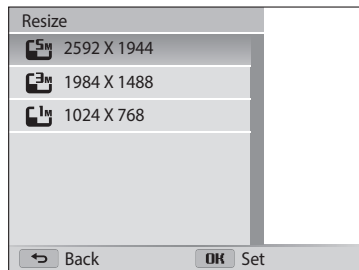

Change the size of a photo and save it as a new file.

- 1 In Playback mode, select a photo, and then press [MENU].
- 2 Select **Resize**.
- 3 Select an option.



Available resize options differ depending on the original size of the photo.

Rotating a photo

- 1 Rotate the mode dial to .
- 2 Select .
- 3 Rotate [Zoom] to the left, and then select a photo.
- 4 Select **Rotate** → an option.

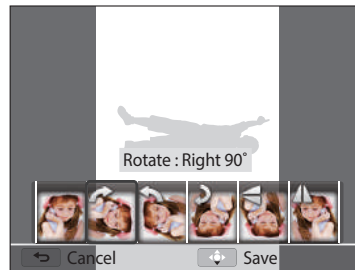



- 5 Press [] to save.



- The camera will overwrite the original file.
- In Playback mode, press [MENU], and then select **Rotate** to rotate a photo.

Applying Smart Filter effects

Apply special effects to your photos.

- 1 Rotate the mode dial to .
- 2 Select .
- 3 Rotate [Zoom] to the left, and then select a photo.
- 4 Select **Smart Filter** → an option.

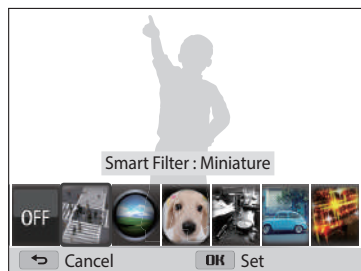

Option	Description
Normal	No effect
Miniature	Apply a tilt-shift effect to make the subject appear in miniature. (The top and bottom of the photo will be blurred.)
Vignetting	Apply the retro-looking colors, high contrast, and strong vignette effect of Lomo cameras.
Fish-eye	Distort close objects to imitate the visual effect of a fisheye lens.
Classic	Apply a black and white effect.
Retro	Apply a sepia tone effect.
Cross Filter	Add lines that radiate outward from bright objects to imitate the visual effect of a cross filter.

- 5 Press [] to save.



Adjusting your photos



Learn how to adjust the brightness, contrast, or saturation or how to correct the red-eye effect. If the center of a photo is dark, you can adjust it to be brighter. The camera will save an edited photo as a new file, but may convert it to a lower resolution.





- You can adjust brightness, contrast, and saturation and apply Smart Filter effects at the same time.
- You cannot apply the ACB, Face Retouch, and Red-eye Fix effects at the same time.



Adjusting brightness, contrast, or saturation

- 1 Rotate the mode dial to .
- 2 Select .
- 3 Rotate [**Zoom**] to the left, and then select a photo.
- 4 Select an adjusting option.





Icon	Description
	Brightness
	Contrast
	Saturation

- 5 Press [] to adjust the option.
- 6 Press [**OK**].
- 7 Press [] to save.



Adjusting dark subjects (ACB)

- 1 Rotate the mode dial to .
- 2 Select .
- 3 Rotate [**Zoom**] to the left, and then select a photo.
- 4 Select **ACB**.
- 5 Press [] to save.

Retouching faces

- 1 Rotate the mode dial to .
- 2 Select .
- 3 Rotate [**Zoom**] to the left, and then select a photo.
- 4 Select **Face Retouch**.
- 5 Press [/- As the number increases, the skin tone becomes brighter and smoother.
- 6 Press [

Removing red-eye

- 1 Rotate the mode dial to .
- 2 Select .
- 3 Rotate [**Zoom**] to the left, and then select a photo.
- 4 Select **Red-eye Fix**.
- 5 Press [

Editing a video

While playing back a video, you can trim the video or capture an image from the video.

Trimming a video

- 1 In Playback mode, select a video, and then press [MENU].
- 2 Select **Trim Movie**.
- 3 Press [OK] to start playing the video.
- 4 Press [OK] → [👉] at the point where you want the trimming to begin.
- 5 Press [OK] to resume playing the video.
- 6 Press [OK] → [👉] at the point where you want the trimming to end.
- 7 Press [👉] to trim.
- 8 When the pop-up message appears, select **Yes**.



- The original video should be at least 10 seconds long.
- The camera will save the edited video as a new file and leave the original video intact.

Capturing an image from video

- 1 While viewing a video, press [OK] at the point where you want to capture an image.
- 2 Press [👉].



- The resolution of the captured image will be the same as the original video.
- The captured image is saved as a new file.

Viewing files on a TV

Play back photos or videos by connecting your camera to a TV with the A/V cable.

- 1 Rotate the mode dial to .
- 2 Select **Connectivity** → **Video Out**.
- 3 Select the video signal output for your country or region. (p. 112)
- 4 Turn off your camera and TV.
- 5 Connect your camera to your TV with the A/V cable.

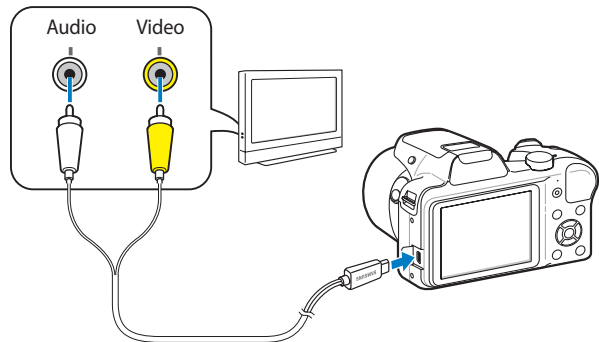

- 6 Turn on your TV, and then select the A/V video source.
- 7 Turn on your camera.
 - The camera automatically enters Playback mode when you connect it to a TV.
- 8 View photos or play videos using the camera buttons.



- Depending on the TV model, you may see some digital noise or part of an image may not appear.
- Images may not be centered on the TV screen depending on your TV settings.

Transferring files to a computer

Connect the camera to the computer, to transfer files from the camera's memory card to the computer.

Transferring files to your Windows OS computer

Connect the camera to your computer as a removable disk.



Your computer must be running Windows XP, Windows Vista, Windows 7, or Windows 8 for you to connect the camera as a removable disk.

- 1 Rotate the mode dial to **⚙**.
- 2 Select **Connectivity** → **i-Launcher** → **Off**.
- 3 Turn off the camera.
- 4 Connect the camera to your computer with the USB cable.



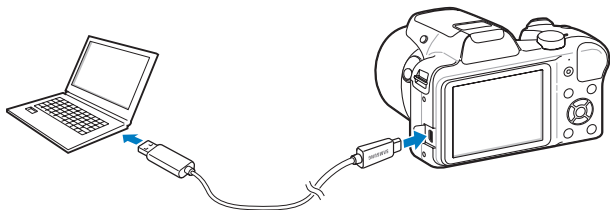

You must plug the small end of the USB cable into your camera. If the cable is reversed, it may damage your files. The manufacturer is not responsible for any loss of data.



- 5 Turn on the camera.
 - The computer recognizes the camera automatically.
- 6 On your computer, select **My Computer** → **Removable Disk** → **DCIM** → **100PHOTO**.
- 7 Drag or save files to your computer.

Disconnecting the camera (for Windows XP)

With Windows Vista, Windows 7 and Windows 8 the methods for disconnecting the camera are similar.

- 1 If the status lamp on your camera is blinking, wait until it stops.
- 2 Click  on the tool bar at the bottom right of your computer screen.

- 3 Click the pop-up message.
- 4 Click the message box that indicates the camera can be removed safely.
- 5 Remove the USB cable.

Transferring files to your Mac OS computer

When you connect the camera to your Mac OS computer, the computer will automatically recognize the device. You can transfer files directly from the camera to the computer without installing any programs.



Mac OS 10.5 or later (except PowerPC) is supported.

- 1 Turn off the camera.
- 2 Connect your camera to your Mac OS computer with the USB cable.



You must plug the small end of the USB cable into your camera. If the cable is reversed, it may damage your files. The manufacturer is not responsible for any loss of data.

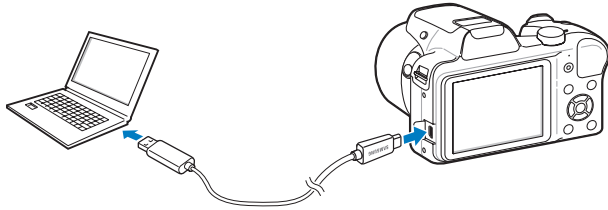

- 3 Turn on the camera.
 - The computer recognizes the camera automatically and displays a removable disk icon.
- 4 On your computer, open the removable disk.
- 5 Drag or save files to your computer.

System Requirements

Recommended system requirements to play videos on a PC or run the i-Launcher application.

Windows OS Requirements

Item	Requirements
CPU	Intel® Pentium®4 3.2 GHz or higher/ AMD Athlon™ FX 2.6 GHz or higher
RAM	Minimum 512 MB RAM (1 GB or more recommended)
OS*	Windows 7 or Windows 8
Hard disk capacity	250 MB or more (1 GB and above recommended)
Others	<ul style="list-style-type: none">• 1024 X 768 pixels, 16-bit color display compatible monitor (1280 X 1024 pixels, 32-bit color display recommended)• USB 2.0 port• nVIDIA Geforce 7600GT or higher/ ATI X1600 series or higher

* A 32-bit version of i-Launcher will be installed—even on 64-bit editions of Windows 7 and Windows 8.

Mac OS requirements

Item	Requirements
OS	Mac OS 10.5 or higher (except PowerPC)
RAM	Minimum 256 MB RAM (512 MB or more recommended)
Hard disk capacity	Minimum 110 MB
Others	USB 2.0 port



- The requirements are recommendations only. It may not work properly even when the computer meets the requirements, depending on the condition of your computer.
- The manufacturer is not responsible for any damage that results from using unqualified computers such as a computer you assembled yourself.

Wireless network



Learn to connect to wireless local area networks (WLANs) and use functions.

Connecting to a WLAN and configuring network settings	93
Connecting to a WLAN	93
Using the login browser	94
Network connection tips	95
Entering text	96
Using the NFC Feature (Tag & Go)	97
Using NFC features in Shooting mode	97
Using NFC features in Playback mode (Photo Beam)	97
Using NFC features in Wi-Fi mode	97
Saving files to a smart phone automatically ...	98
Sending photos or videos to a smart phone ...	99
Using a smart phone as a remote shutter release	100
Sending photos or videos via email	102
Changing email settings	102
Sending photos or videos via email	104
Using photo or video sharing services	105
Accessing a sharing service	105
Uploading photos or videos	105
Using Samsung Link to send files	107
Viewing photos or videos on devices that support Samsung Link	107

Connecting to a WLAN and configuring network settings





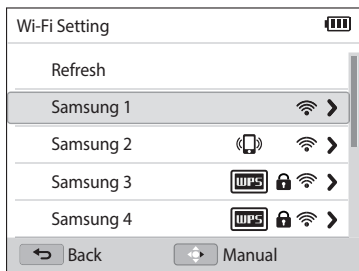

Learn to connect via an access point (AP) when you are in a range of a WLAN. You can also configure network settings.



Connecting to a WLAN

- 1 Rotate the mode dial to Wi-Fi.
- 2 Select , , or .
- 3 Follow the on-screen instructions until the Wi-Fi Setting screen appears.
 - The camera automatically searches for available AP devices.
 - In some modes, press **[MENU]**, and then select **Wi-Fi Setting**.
- 4 Select an AP.



- Select **Refresh** to refresh the list of connectable APs.
- Select **Add wireless network** to add an AP manually. The AP name must be in English to add the AP manually.

Icon	Description
	Ad hoc AP
	Secured AP
	WPS AP
	Signal strength
	Press  to open network setting options.

- When you select a secured AP, a pop-up window appears. Enter the required passwords to connect to the WLAN. For information about entering text, refer to "Entering text". (p. 96)
- When a login page appears, refer to "Using the login browser". (p. 94)
- When you select an unsecured AP, the camera will connect to the WLAN.
- If you select a WPS profile supported AP, select  → **WPS PIN connection**, and then enter a PIN on the AP device. You can also connect to a WPS profile supported AP by selecting  → **WPS button connection** on the camera, and then pushing the **WPS** button on the AP device.
- If a pop-up message about data collection regulations appears, read and agree to it.

Setting network options

- 1 In the Wi-Fi Setting screen, move to an AP, and then press [📶].
- 2 Select each option, and then enter the required information.

Option	Description
Network Password	Enter the network password.
IP Setting	Set the IP address automatically or manually.

Manually setting the IP address

- 1 In the Wi-Fi Setting screen, move to an AP, and then press [📶].
- 2 Select **IP Setting** → **Manual**.
- 3 Select each option, and then enter the required information.

Option	Description
IP	Enter the static IP address.
Subnet Mask	Enter the subnet mask.
Gateway	Enter the gateway.
DNS Server	Enter the DNS address.

Using the login browser

You can enter your login information via the login browser when connecting to some APs, sharing sites, or cloud servers.

Button	Description
[DISP/📶/🔋/📶]	Move to an item or scroll the page.
[OK]	Select an item.
[MENU]	Access the following options: <ul style="list-style-type: none"> • Previous Page: Move to the previous page. • Next Page: Move to the next page. • Reload: Reload the page. • Stop: Stop loading the page. • Exit: Close the login browser.
[↵]	Close the login browser.



- You may not be able to select some items depending on the page you connected to. This does not indicate a malfunction.
- The login browser may not close automatically after you log into some pages. If this occurs, close the login browser by pressing [↵], and then proceed with the desired operation.
- It may take longer to load the login page due to the page size or network speed. If this occurs, wait until the login information input window appears.

Network connection tips

- Some Wi-Fi features are not available if you do not insert a memory card.
 - The quality of the network connection will be determined by the AP.
 - The further the distance between your camera and the AP, the longer it will take to connect to the network.
 - If a nearby device is using the same radio frequency signal as your camera, it may interrupt your connection.
 - If your AP name is not in English, the camera may not be able to locate the device or the name may appear incorrectly.
 - For network settings or a password, contact your network administrator or network service provider.
 - If a WLAN requires authentication from the service provider, you may not be able to connect to it. To connect to the WLAN, contact your network service provider.
 - Depending on the encryption type, the number of digits in the password may differ.
 - A WLAN connection may not be possible in all surroundings.
 - The camera may display a WLAN enabled printer on the AP List. You cannot connect to a network via a printer.
 - You cannot connect your camera to a network and a TV simultaneously.
 - Connecting to a network may incur additional charges. Costs will vary based on the conditions of your contract.
- If you cannot connect to a WLAN, try another AP from the available AP list.
 - A login page may appear when you select free WLANs provided by some network service providers. Enter your ID and password to connect to the WLAN. For information about registering or the service, contact the network service providers.
 - Be cautious when you enter personal information for an AP connection. Do not enter any payment or credit card information on your camera. The manufacturer is not liable for any problem caused by entering such information.
 - Available network connections may differ by country.
 - The WLAN feature of your camera must comply with radio transmission laws in your region. To ensure compliance, use the WLAN feature only in the country where you purchased the camera.
 - The process for adjusting network settings may differ, depending on network conditions.
 - Do not access a network that you are not authorized to use.
 - Before you connect to a network, ensure your battery is fully charged.
 - You cannot upload or send files captured in some modes.
 - Files that you transfer to another device may not be supported by the device. In this case, use a computer to playback the files.

Entering text

Learn how to enter text. The icons in the table below let you move the cursor, change the case, etc. Press [DISP/⌨/↵/⌂] to move to a desired key, and then press [OK] to enter the key.

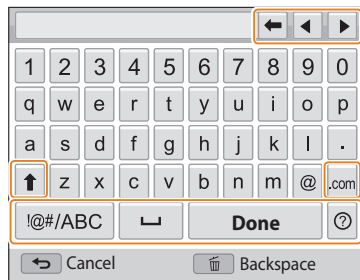

Icon	Description
	Delete the last letter.
	Move the cursor.
	In ABC mode, change the case.
.com	Enter ".com".
!@#/ABC	Switch between Symbol mode and ABC mode.
	Enter a space.
Done	Save the displayed text.
	View the entering text guide.



- You can use only the English alphabets in some modes, regardless of the display language.
- To move to **Done** directly, press [▶].
- You can enter up to 64 characters.
- The screen may differ depending on the input mode.

Using the NFC Feature (Tag & Go)

Place a smart phone's NFC tag near the camera's NFC tag to launch the feature for saving photos to a smart phone automatically or the feature for using a smart phone as a remote shutter. You can also transfer files to an NFC-enabled device in Playback mode.



- This feature is supported by NFC-enabled smart phones running Android OS. It is recommended that you use the latest version. This feature is not available for iOS devices.
- You should install Samsung SMART CAMERA App on your phone or device before using this feature. You can download the application from Samsung Apps or the Google Play Store. Samsung SMART CAMERA App is compatible with Samsung camera models manufactured in 2013 or later.
- To read an NFC tag, place the NFC-enabled device near the camera's NFC tag for more than 2 seconds.
- Do not modify the tag information in any way.

Using NFC features in Shooting mode

Launch AutoShare or Remote Viewfinder by reading a tag from an NFC-enabled device. (p. 98, 100) Preset to launch the Wi-Fi function by reading a tag on an NFC-enabled device. (p. 114)

Using NFC features in Playback mode (Photo Beam)

In Playback mode, the camera transfers the current file to the smart phone automatically when you read a tag from an NFC-enabled device.

- To transfer multiple files, read a tag from an NFC-enabled device in the thumbnail view, and then select files.

Using NFC features in Wi-Fi mode

Select MobileLink or Remote Viewfinder from the pop-up window that appears by reading a tag from an NFC-enabled device. (p. 99, 100)



Saving files to a smart phone automatically

The camera connects to a smart phone that supports the AutoShare feature via a WLAN. When you capture a photo with your camera, the photo is saved to the smart phone automatically.



- The AutoShare feature is supported by smart phones or tablets running Android OS or iOS. Some features may not be supported by some models. Before using this feature, update the device's firmware to the latest version. If the firmware version is not the most recent, this function may not perform properly.
- You should install the Samsung SMART CAMERA App on your phone or device before using this feature. You can download the application from Samsung Apps, the Google Play Store, or the Apple App Store. The Samsung SMART CAMERA App is compatible with Samsung camera models manufactured in 2013 or later.
- If you set this function, the setting is maintained even when you change the Shooting mode.
- This feature may not be supported in some modes.

- 1 On the camera, in Shooting mode, press [MENU].
- 2 On the camera, select **AutoShare** → **On**.
 - If the pop-up message that prompts you to download the application appears, select **Next**.
- 3 On the smart phone, turn on the Samsung SMART CAMERA App.
 - For iOS devices, turn on the Wi-Fi feature before turning on the application.
 - To start the application automatically on an NFC-enabled smart phone, turn on the function and place the smart phone near the NFC tag (p. 21) on the camera.
- 4 Select the camera from the list and connect the smart phone to the camera.
 - The smart phone can connect to only one camera at a time.
- 5 On the camera, allow the smart phone to connect to your camera.
 - If the smart phone has been connected to your camera before, it is connected automatically.
 - An icon that shows the connection status (📶) will appear on the camera's screen.
- 6 On the camera, capture a photo.
 - The captured photo is saved to the camera, and then transferred to the smart phone.

Sending photos or videos to a smart phone

The camera connects to a smart phone that supports the MobileLink feature via a WLAN. You can easily send photos or videos to your smart phone.



- The MobileLink feature is supported by smart phones or tablets running Android OS or iOS. Some features may not be supported by some models. Before using this feature, update the device's firmware to the latest version. If the firmware version is not the most recent, this function may not perform properly.
- You should install the Samsung SMART CAMERA App on your phone or device before using this feature. You can download the application from Samsung Apps, the Google Play Store, or the Apple App Store. The Samsung SMART CAMERA App is compatible with Samsung camera models manufactured in 2013 or later.
- When there are no files in the camera memory, you cannot use this feature.
- If you select files from the smart phone, you can view up to 1,000 recent files and send up to 1,000 files at a time. If you select files from the camera, you can view files that were selected from the camera and the maximum number of files you can send varies depending on the storage space of the smart phone.
- When using this feature on an iOS device, the device may lose its Wi-Fi connection.

- 1 On the camera, rotate the mode dial to **Wi-Fi**.
- 2 On the camera, select .
 - If the pop-up message that prompts you to download the application appears, select **Next**.
- 3 On the camera, select a sending option.
 - If you select **Select Files from Smartphone**, you can use your smart phone to view and share files stored on the camera.
 - If you select **Select Files from Camera**, you can select files to send on the camera.
- 4 On the smart phone, turn on the Samsung SMART CAMERA App.
 - For iOS devices, turn on the Wi-Fi feature before turning on the application.
 - To start the application automatically on an NFC-enabled smart phone, turn on the function and place the smart phone near the NFC tag (p. 21) on the camera.
- 5 Select the camera from the list and connect the smart phone to the camera.
 - The smart phone can connect to only one camera at a time.
- 6 On the camera, allow the smart phone to connect to your camera.
 - If the smart phone has been connected to your camera before, it is connected automatically.
 - The application on the smart phone can be closed if no operations are performed on the camera for 30 seconds.
- 7 On the smart phone or camera, select files to transfer from the camera.
- 8 On the smart phone, touch the copy button or on the camera, select **Send**.
 - The camera will send the files.



The camera screen turns off if you perform no operations on the camera for 30 seconds.

Using a smart phone as a remote shutter release

The camera connects to a smart phone via a WLAN. Use the smart phone as a remote shutter release with the Remote Viewfinder feature. The captured photo will display on the smart phone.



- The Remote Viewfinder feature is supported by smart phones or tablets running Android OS or iOS. Some features may not be supported by some models. Before using this feature, update the device's firmware to the latest version. If the firmware version is not the most recent, this function may not perform properly.
- You should install the Samsung SMART CAMERA App on your phone or device before using this feature. You can download the application from Samsung Apps, the Google Play Store, or the Apple App Store. The Samsung SMART CAMERA App is compatible with Samsung camera models manufactured in 2013 or later.

- 1 On the camera, rotate the mode dial to **Wi-Fi**.
- 2 On the camera, select .
 - If the pop-up message that prompts you to download the application appears, select **Next**.
- 3 On the smart phone, turn on the Samsung SMART CAMERA App.
 - For iOS devices, turn on the Wi-Fi feature before turning on the application.
 - To start the application automatically on an NFC-enabled smart phone, turn on the function and place the smart phone near the NFC tag (p. 21) on the camera.
- 4 Select the camera from the list and connect the smart phone to the camera.
 - The smart phone can connect to only one camera at a time.
- 5 On the camera, allow the smart phone to connect to your camera.
 - If the smart phone has been connected to your camera before, it is connected automatically.
- 6 On the smart phone, set the following shooting options.
 - While using this feature, some buttons are not available on your camera.
 - With the smart phone, you can operate the camera only by touching the screen.
 - Remote Viewfinder mode supports the 10M or 3M photo sizes only.

7 On the smart phone, touch and hold  to focus.

- The focus is automatically set to **Multi AF**.

8 Release  to capture the photo.



- When you use this feature, the ideal distance between the camera and the smart phone may vary, depending on your surroundings.
- The smart phone must be within 23 feet (7 m) when you use this feature.
- It will take some time to capture the photo after you release  on the smart phone.
- The Remote Viewfinder function will deactivate when:
 - either the camera or the smart phone turn off
 - either device loses its connection to the WLAN
 - the Wi-Fi connection is poor or unstable
 - you perform no operations for approximately 3 minutes while connected
- The camera screen turns off if you perform no operations on the camera for 30 seconds.

Sending photos or videos via email

You can change settings in the email menu and send photos or videos stored on the camera via email.

Changing email settings

In the email menu, you can change settings for storing your information. You can also set or change the email password. For information about entering text, refer to "Entering text". (p. 96)

Storing your information

- 1 Rotate the mode dial to Wi-Fi.
- 2 Select .
- 3 Connect to a WLAN. (p. 93)
- 4 Press [MENU].
- 5 Select **Sender Setting**.

- 6 Select the **Name** box, enter your name, and then select **Done**.

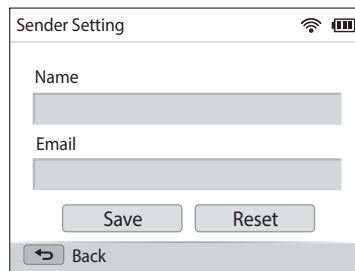

The screenshot shows the 'Sender Setting' menu on a device. At the top, there is a title bar with 'Sender Setting' on the left and Wi-Fi and battery icons on the right. Below the title bar, there are two text input fields: 'Name' and 'Email'. The 'Name' field is currently selected, indicated by a grey highlight. Below the input fields, there are two buttons: 'Save' and 'Reset'. At the bottom of the screen, there is a 'Back' button with a left-pointing arrow icon.

- 7 Select the **Email** box, enter your email address, and then select **Done**.
- 8 Select **Save** to save your changes.
 - To delete your information, select **Reset**.

Setting an email password

- 1 Rotate the mode dial to Wi-Fi.
- 2 Select .
- 3 Connect to a WLAN. (p. 93)
- 4 Press [MENU].
- 5 Select **Setting Password** → **On**.
 - To deactivate the password, select **Off**.
- 6 When the pop-up appears, select **OK**.
- 7 Enter a 4-digit password.
- 8 Enter the password again.
- 9 When the pop-up appears, select **OK**.



If you forget your password, you can reset it by selecting **Reset** on the password setting screen. When you reset the information the previously saved user's setting information, email address, and recently sent email list will be deleted.

Changing the email password

- 1 Rotate the mode dial to Wi-Fi.
- 2 Select .
- 3 Connect to a WLAN. (p. 93)
- 4 Press [MENU].
- 5 Select **Change Password**.
- 6 Enter your current 4-digit password.
- 7 Enter a new 4-digit password.
- 8 Enter the new password again.
- 9 When the pop-up appears, select **OK**.

Sending photos or videos via email

You can send photos or videos stored on the camera via email. For information about entering text, refer to "Entering text". (p. 96)

- 1 Rotate the mode dial to **Wi-Fi**.
- 2 Select .
- 3 Connect to a WLAN. (p. 93)
- 4 Select the **Sender** box, enter your email address, and then select **Done**.
 - If you have previously saved your information, it will be inserted automatically. (p. 102)
 - To use an address from the list of previous senders, select ▼ → an address.
- 5 Select the **Receiver** box, enter an email address, and then select **Done**.
 - To use an address from the list of previous recipients, select ▼ → an address.
 - Select + to add additional recipients. You can input up to 30 recipients.
 - Select ✕ to delete an address from the list.
- 6 Select **Next**.

- 7 Scroll to files to send, and then press [OK].
 - You can select up to 20 files. The total size must be 7 MB or less.
- 8 Select **Next**.
- 9 Select the comment box, enter your comments, and then select **Done**.
- 10 Select **Send**.
 - The camera will send the email.



- Even if a photo appears to have transferred successfully, errors with the recipient's email account may cause the photo to be rejected or recognized as spam.
- You may not be able to send an email if no network connection is available or if your email account settings are incorrect.
- You cannot send an email if the combined file sizes exceed the 7MB. The maximum resolution of photos you can send is 2M. The maximum resolution of videos you can send is $\frac{2560}{1080}$. If the selected photo has a resolution higher than 2M, it will be automatically resized to a lower resolution.
- If you cannot send an email because of firewall or user authentication settings, contact your network administrator or network service provider.
- When there are no files in the camera memory, you cannot use this feature.
- You can also send an email in Playback mode by pressing [MENU], and then selecting **Share(Wi-Fi)** → **Email**.

Using photo or video sharing services

Upload your photos or videos to file sharing services. Available sharing services will be displayed on your camera. To upload files to some sharing services, you must visit the services and register before connecting your camera.

Accessing a sharing service

- 1 Rotate the mode dial to Wi-Fi.
- 2 Select .
- 3 Select a sharing service.
 - If the pop-up message that prompts you to create an account appears, select **OK**.
- 4 Connect to a WLAN. (p. 93)
- 5 Enter your ID and password to log in.
 - For information about entering text, refer to "Entering text". (p. 96)
 - To select an ID from the list, select ▼ → an ID.
 - If you have previously logged in to the sharing service, you may be logged in automatically.



You must have an existing account on the file sharing services to use this feature.

Uploading photos or videos

- 1 Access the sharing service with your camera.
- 2 Select files to upload.
 - You can select up to 20 files. The total size must be 10 MB or less. (On some sharing services, the total size or number of files may vary.)
- 3 Select **Upload**.
 - The camera will upload photos or videos.
 - On some sharing services, you can enter your comments by selecting the comment box. For information about entering text, refer to "Entering text". (p. 96)



- You can set an upload folder for Facebook by pressing [MENU], and then selecting **Upload Folder (Facebook)** on the sharing service's list screen.
- You cannot upload files if the file size exceeds the limit. The maximum resolution of photos you can upload is 2M. The maximum resolution of videos you can upload is $\frac{240}{1080}$. If the selected photo has a resolution higher than 2M, it will be automatically resized to a lower resolution. (On some sharing services, the maximum photo resolution may vary.)
- The method of uploading photos or videos may differ depending on the selected sharing service.
- If you cannot access a sharing service because of firewall or user authentication settings, contact your network administrator or network service provider.
- Uploaded photos or videos may be automatically titled with the date they were captured.
- The speed of your internet connection may affect how quickly photos upload or web pages open.
- When there are no files in the camera memory, you cannot use this feature.
- You can also upload photos or videos to file sharing services in Playback mode by pressing [MENU], and then selecting **Share(Wi-Fi)** → a sharing service.
- You cannot upload videos to some sharing services.

Using Samsung Link to send files

You can view files on a Samsung Link device connected to the same AP.

Viewing photos or videos on devices that support Samsung Link

- 1 Rotate the mode dial to Wi-Fi.
- 2 Select  → **Nearby devices**.
 - If the guide message appears, select **OK**.
 - The camera will automatically attempt to connect to a WLAN via the most recently connected AP device.
 - If the camera has not previously been connected to a WLAN, it will search for available AP devices. (p. 93)
 - You can set to allow only selected devices or all devices to connect by pressing [**MENU**], and then selecting **DLNA Access Control** on the screen.
 - A sharing file list is created. Wait until other devices can find your camera.
- 3 Connect the Samsung Link device to a network, and then turn on the Samsung Link feature.
 - Refer to your device's user manual for more information.
- 4 On the camera, allow the Samsung Link device to connect to your camera.
- 5 On the Samsung Link device, select a camera to connect to.

- 6 On the Samsung Link device, browse the shared photos or videos.
 - For information about searching for the camera and browsing the photos or videos on the Samsung Link device, refer to the device's user manual.
 - Videos may not play smoothly depending on the type of Samsung Link device or the network condition. If this happens, re-record the video in **VGA**(640 X 480) or smaller quality and play it again. If videos do not play smoothly on your device over the wireless connection, try connecting the camera to the device with an A/V cable.

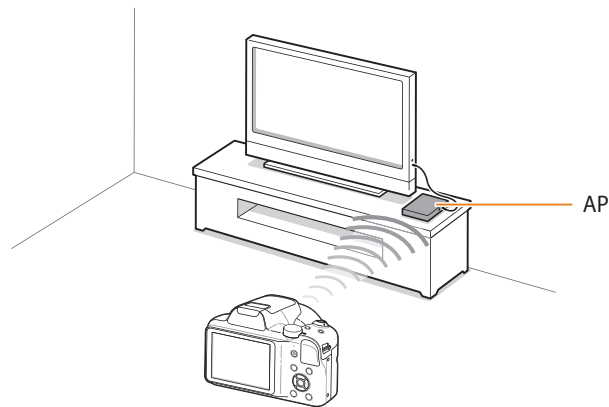

▲ The camera is connected to a TV that supports Samsung Link via WLAN.



- You can share up to 1,000 recent files.
- On a Samsung Link device, you can view only photos or videos captured with your camera.
- The range of the wireless connection between your camera and a Samsung Link device may vary depending on the specifications of the AP.
- If the camera is connected to 2 Samsung Link devices, playback may be slower.
- Photos or videos will be shared in their original sizes.
- You can use this feature only with devices that support Samsung Link.
- Shared photos or videos will not be stored on the Samsung Link device, but they can be stored in the camera to meet the device's specifications.
- Transferring photos or videos to the Samsung Link device may take some time depending on the network connection, the number of files to be shared, or the sizes of the files.
- If you power off the camera abnormally while viewing photos or videos on a Samsung Link device (for example, by removing the battery), the device considers the camera to still be connected.
- The order of photos or videos on the camera may be different than on the Samsung Link device.
- Depending on the number of photos or videos you want to share, it may take some time to load your photos or videos and complete the initial set-up process.
- While viewing photos or videos on the Samsung Link device, continuously using the device's remote or performing additional operations on the device may prevent this feature from working properly.
- If you reorder or sort files on the camera while viewing them on a Samsung Link device, you must repeat the initial set-up process to update the list of files on the device.
- When there are no files in the camera memory, you cannot use this feature.
- We recommend you use a network cable to connect your Samsung Link device to your AP. This will minimize any video 'Stuttering' you may experience when streaming content.
- To view files on a Samsung Link device using the **Nearby devices** feature, enable multicast mode on your AP.

Settings

Refer to options to configure your camera's settings.

Settings menu	110
Accessing the settings menu	110
Sounds	111
Display	111
Connectivity	112
General	113





Settings menu

Learn to configure your camera's settings.

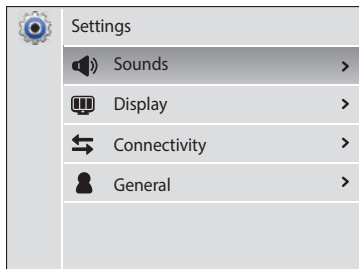
Accessing the settings menu

- 1 Rotate the mode dial to .
- 2 Select a menu.



Icon	Description
	Sounds: Set various camera sounds and the volume. (p. 111)
	Display: Customize the display settings. (p. 111)
	Connectivity: Set the connection options. (p. 112)
	General: Change the settings for the camera system such as memory format and default file name. (p. 113)

- 3 Select an item.

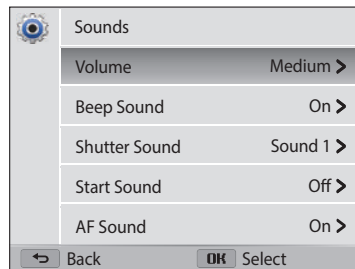

- 4 Select an option.

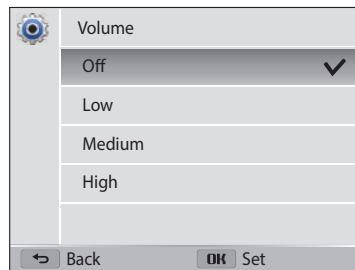

- 5 Press [>] to return to the previous screen.



Sounds

* Default



Item	Description
Volume	Set the volume of all sounds. (Off, Low, Medium* , High)
Beep Sound	Set the sound the camera emits when you press the buttons or switch modes. (Off, On*)
Shutter Sound	Set the sound the camera emits when you press the shutter button. (Off, Sound 1* , Sound 2, Sound 3)
Start Sound	Set the sound the camera emits when you turn on your camera. (Off* , Star Flight, Laser Show, Cloud)
AF Sound	Set the sound the camera emits when you half-press the shutter button. (Off, On*)

Display

* Default

Item	Description
Start Image	<p>Set a start image to display when the camera turns on.</p> <ul style="list-style-type: none"> • Off*: Display no start image. • Logo: Display a default image stored in the internal memory. • User Image: Select User Image from the photos you captured in the memory. <p> If you select a new photo as a User Image or reset your camera, the camera will delete the current image.</p>
Guide Line	Select a guide to help you compose a scene. (Off* , 3 X 3, 2 X 2, Cross, Diagonal)
Date/Time Display	Set whether or not to display the date and time on the camera's display. (Off* , On)
Help Display	Display a brief description of an option or menu. (Off, On*)
Display Brightness	<p>Adjust the brightness of the screen. (Auto*, Dark, Normal, Bright)</p> <p> Normal is fixed in Playback mode even if you have selected Auto.</p>

* Default

Item	Description
Quick View	Set whether or not to review a captured image before returning to the Shooting mode. (Off, On*)  This feature does not work in some modes.
Auto Display Off	If you perform no operations for 30 seconds, the camera automatically switches to Auto Display Off mode. (Off*, On)  In Auto Display Off mode, press any button other than [⏻] to resume using the camera.



Connectivity

* Default

Item	Description
Video Out	Set the video signal output for your region. <ul style="list-style-type: none"> • NTSC: USA, Canada, Japan, Korea, Taiwan, Mexico, etc • PAL (supports only BDGH!): Australia, Austria, Belgium, China, Denmark, England, Finland, France, Germany, Italy, Kuwait, Malaysia, Netherlands, New Zealand, Norway, Singapore, Spain, Sweden, Switzerland, Thailand, etc
i-Launcher	Set i-Launcher to launch automatically when you connect your camera to your computer. (Off, On*)

General



* Default

Item	Description
Network Information	View the Mac address and network certification number of your camera.
Language	Set a language for the display text.
Time Zone	Set the time zone for your location. When you travel to another country, select Visit , and then select the appropriate time zone. (Home* , Visit)
Date/Time Set	Set the date and time.
Date Type	Set a date format. (YYYY/MM/DD , MM/DD/YYYY , DD/MM/YYYY)  The default date type may differ depending on the language selected.
Time Type	Set the time format. (12 Hr , 24 Hr)  The default time type may differ depending on the language selected.

* Default

Item	Description
File No.	Specify how to name files. <ul style="list-style-type: none"> • Reset: Set the file number to start from 0001 when you insert a new memory card, format a memory card, or delete all files. • Series*: Set the file number to resume from the previous file number when you insert a new memory card, format a memory card, or delete all files.  The default name of the first folder is 100PHOTO and the default name of the first file is SAM_0001. • The file number increases by one, from SAM_0001 to SAM_9999, each time you take a picture. • The folder number increases by one, from 100PHOTO to 999PHOTO, each time a folder is full. • The maximum number of files that can be stored in one folder is 9,999. • The camera defines file names according to the Design rule for Camera File system (DCF) standard. If you intentionally change file names, the camera may not play back the files.

* Default

Item	Description
Imprint	<p>Set whether or not to display the date and time on captured photos. (Off*, Date, Date & Time)</p>  <ul style="list-style-type: none"> The date and time will be displayed on the bottom right corner of the photo. Some printer models may not print the date and time properly. The photo will not display the date and time if: <ul style="list-style-type: none"> you select  mode
Auto Power Off	<p>Set the camera to turn off automatically when you perform no operations for a specified period. (Off, 1 min, 3 min*, 5 min, 10 min)</p>  <ul style="list-style-type: none"> Your settings will not change when you replace the battery. The camera will not turn off automatically when the camera is connected to a computer or WLAN or when you are playing a slide show or videos.
DIRECT LINK (Wi-Fi Button)	<p>Start a preset Wi-Fi function by pressing [DIRECT LINK]. (AutoShare, MobileLink*, Remote Viewfinder, Email, SNS & Cloud, Samsung Link)</p>

* Default

Item	Description
Live view NFC	<p>Set a Wi-Fi function to launch by reading a tag from an NFC-enabled device in Shooting mode. (AutoShare, Remote Viewfinder*)</p>
AF Lamp	<p>Set a light to turn off automatically in dark places to help you focus. (Off, On*)</p>
Format	<p>Format the memory. Formatting will delete all files, including protected files. (Yes, No*)</p>  <p>Errors can occur if you use a memory card formatted by another brand of camera, a memory card reader, or a computer. Please format memory cards in the camera before using them to capture photos.</p>
Reset	<p>Reset menus and shooting options. Date and time, language, and video output settings will not be reset. (Yes, No*)</p>
Open Source Licenses	<p>Show the Open source licenses information.</p>

Appendixes

Get information about error messages, specifications, and maintenance.

Error messages	116
Camera maintenance	117
Cleaning your camera	117
Using or storing the camera	118
About memory cards	120
About the battery	123
Upgrading Firmware	127
Before contacting a service center	128
Camera specifications	131
Glossary	135
Index	142

Error messages

When the following error messages appear, try these remedies.

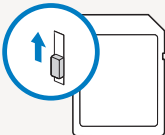
Error message	Suggested remedies
Cannot read file content	Delete the damaged file or contact a service center.
Card Error	<ul style="list-style-type: none">• Turn off your camera, and then turn it on again.• Remove your memory card, and then insert it again.• Format your memory card.
Card Locked	<p>You can lock an SD, SDHC, or SDXC card to prevent files from being deleted. Unlock the card when shooting.</p> 
Card not supported.	The inserted memory card is not supported by your camera. Insert a SD, SDHC, or SDXC memory card.
Connection failed.	<ul style="list-style-type: none">• The camera cannot connect to the network using the selected access point. Select another AP and try again.• The camera has failed to connect to the other devices. Try connecting again.
Device disconnected.	Network connection disconnected while photos are being transferred to supported devices. Re-select a supported device.
File Error	Delete the damaged file or contact a service center.

Error message	Suggested remedies
File system not supported.	Your camera does not support the FAT file structure of the inserted memory card. Format the memory card on the camera.
Initialization failed.	The camera has failed to locate a device that supports Samsung Link. Turn on devices on the network that support Samsung Link.
Low Battery	Insert a charged battery or recharge the battery.
Memory Full	Delete unnecessary files or insert a new memory card.
No Image File	Capture photos or insert a memory card that contains some photos.
Password Incorrect	The password for transferring files to another camera is wrong. Enter the correct password.
Transfer failed.	<ul style="list-style-type: none">• The camera has failed to send e-mails or files to the other devices. Try sending again.• Check the network connection and try again.
DCF Full Error	File names do not match the DCF standard. Transfer the files from the memory card to your computer and format the card. Then, open the Settings menu and select General → File No. → Reset. (p. 113)

Camera maintenance

Cleaning your camera

Camera lens and display

Use a blower brush to remove dust and wipe the lens gently with a soft cloth. If any dust remains, apply lens cleaning liquid to a piece of lens cleaning paper and wipe gently.

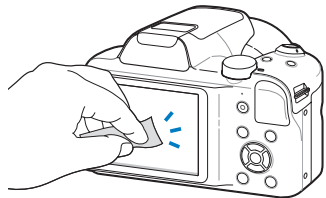
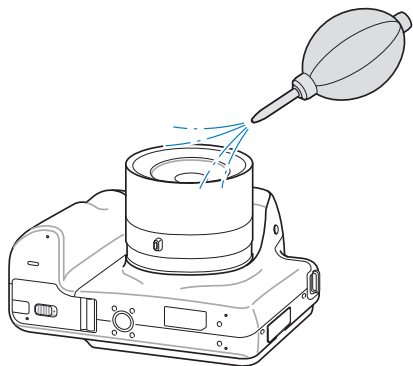

Camera body

Wipe gently with a soft, dry cloth.

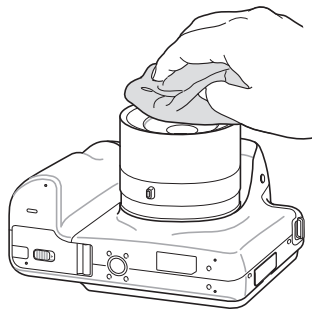

- Never use benzene, thinners, or alcohol to clean the device. These solutions can damage the camera or cause it to malfunction.
- Do not press on the lens cover or use a blower brush on the lens cover.

Using or storing the camera

Inappropriate places to use or store the camera

- Avoid exposing the camera to very cold or very hot temperatures.
- Avoid using your camera in areas with extremely high humidity, or where the humidity changes drastically.
- Avoid exposing the camera to direct sunlight and storing it in hot, poorly-ventilated areas, such as in a car during summer time.
- Protect your camera and the display from impact, rough handling, and excessive vibration to avoid serious damage.
- Avoid using or storing your camera in dusty, dirty, humid, or poorly-ventilated areas to prevent damage to moving parts and internal components.
- Do not use your camera near fuels, combustibles, or flammable chemicals. Do not store or carry flammable liquids, gases, or explosive materials in the same compartment as the camera or its accessories.
- Do not store the camera where there are mothballs.

Using on beaches or shores

- Protect your camera from sand and dirt when you use it on beaches or in similar areas.
- Your camera is not waterproof. Do not handle the battery, adapter, or memory card with wet hands. Operating the camera with wet hands may cause damage to your camera.

Storing for extended period of time

- When you store the camera for an extended period, place it in a sealed container with an absorbent material, such as silica gel.
- Over time, unused batteries will discharge and must be recharged before use.
- The present date and time can be initialized when the camera is turned on after the camera and battery have been separated for a prolonged period.

Using the camera with caution in humid environments

When you transfer the camera from a cold environment to a warm one, condensation can form on the lens or internal components of the camera. In this situation, turn off the camera and wait for at least 1 hour. If condensation forms on the memory card, remove the memory card from the camera and wait until all moisture has evaporated before reinserting it.

Other cautions

- Do not swing your camera by the strap. This may cause injury to yourself or others or damage to your camera.
- Do not paint your camera, as paint can clog moving parts and prevent proper operation.
- Turn off the camera when not using it.
- Your camera contains delicate parts. Avoid impacts to the camera.

- Protect the display from external force by keeping it in the case when not in use. Protect the camera from scratches by keeping it away from sand, sharp implements, or loose change.
- Do not use the camera if the screen is cracked or broken. Broken glass or acrylic could cause injury to your hands and face. Take the camera to a Samsung service center to have it repaired.
- Never place cameras, batteries, chargers, or accessories near, on, or in heating devices, such as microwave ovens, stoves, or radiators. Heat can deform or overheat these devices, which can cause a fire or explosion.
- Do not expose the lens to direct sunlight, as this may discolor the image sensor or cause it to malfunction.
- Protect the lens from fingerprints and scratches. Clean the lens with a soft, clean, debris-free lens cloth.
- The camera may turn off if struck or dropped. This is to protect the memory card. Turn on the camera to use it again.
- While you use the camera, it may heat up. This is normal and should not affect your camera's lifespan or performance.
- When you use the camera in low temperatures, it may take some time to turn on, the color of the display may be changed temporarily, or after-images may appear. These conditions are not malfunctions and they will correct themselves when the camera is returned to milder temperatures.
- Paint or metal on the outside of the camera may cause allergies, itchy skin, eczema, or swelling for people with sensitive skin. If you experience any of these symptoms, stop using the camera immediately and consult a doctor.
- Do not insert foreign objects into any of your camera's compartments, slots, or access points. Damage due to improper use may not be covered by your warranty.
- Do not allow unqualified personnel to service the camera or attempt to service the camera yourself. Any damage that results from unqualified service is not covered by your warranty.

About memory cards

Supported memory cards

This product supports SD (Secure Digital), SDHC (Secure Digital High Capacity), SDXC (Secure Digital eXtended Capacity), microSD, microSDHC, or microSDXC memory cards.

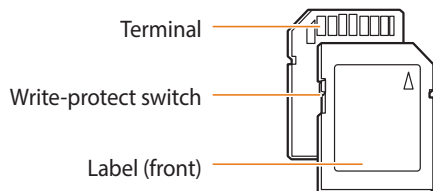

You can prevent files from being deleted by using the write protect switch on an SD, SDHC, or SDXC card. Slide the switch down to lock or slide it up to unlock. Unlock the card when capturing photos and videos.

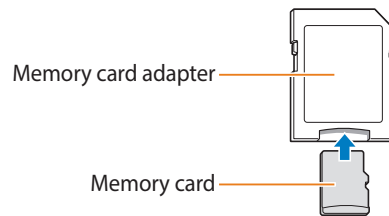









To use micro memory cards with this product, a PC, or a memory card reader, insert the card into an adapter.

Memory card capacity

The memory capacity may differ depending on shooting scenes or shooting conditions. These capacities are based on a 2 GB SD card:

Photo

Size	Super Fine	Fine	Normal
 16M	325	488	673
 14MP	264	525	697
 12M	407	610	813
 10M	360	723	943
 8M	592	849	1,146
 5M	673	1139	1,463
 3M	957	1,619	1,928
 2M	1,382	2,263	2,740
 1M	2,645	3,147	3,682

Video

Size	30fps
HD 1280 X 720	Approx. 15' 45"
VGA 640 X 480	Approx. 30' 45"
QVGA 320 X 240	Approx. 90' 06"
 For Sharing	Approx. 90' 06"

The figures above are measured without using the zoom function. Available recording time may vary if you use the zoom. Several videos were recorded in succession to determine the total recording time.

Cautions when using memory cards

- Avoid exposing memory cards to very cold or very hot temperatures (below 0 °C/32 °F or above 40 °C/104 °F). Extreme temperatures can cause memory cards to malfunction.
 - Insert a memory card in the correct direction. Inserting a memory card in the wrong direction may damage your camera and memory card.
 - Do not use memory cards that have been formatted by other cameras or by a computer. Reformat the memory card with your camera.
 - Turn off the camera before you insert or remove the memory card.
 - Do not remove the memory card or turn off your camera while the lamp is blinking, as this may damage your data.
 - When the lifespan of a memory card has expired, you cannot store any more photos on the card. Use a new memory card.
 - Do not bend, drop, or subject memory cards to heavy impact or pressure.
 - Avoid using or storing memory cards near strong magnetic fields.
 - Avoid using or keeping memory cards in areas with high temperature, high humidity, or corrosive substances.
- Prevent memory cards from making contact with liquids, dirt, or foreign substances. If dirty, wipe the memory card clean with a soft cloth before you insert the memory card into your camera.
 - Do not allow liquids, dirt, or foreign substances to come in contact with memory cards or the memory card slot. Doing so may cause memory cards or the camera to malfunction.
 - When you carry a memory card, use a case to protect the card from electrostatic discharges.
 - Transfer important data to other media, such as a hard disk, CD, or DVD.
 - When you use the camera for an extended period, the memory card may become warm. This is normal and does not indicate a malfunction.



The manufacturer is not responsible for any loss of data.

About the battery

Use only Samsung-approved batteries.

Battery specifications

Specification	Description
Model	SLB-10A
Type	Lithium-ion battery
Cell capacity	1030 mAh
Voltage	3.7 V
Charging time* (when the camera is switched off)	Approximately 240 min

* Charging the battery by connecting it to a computer may take longer.

Battery life

Average shooting time/ Number of photos		Test conditions (when the battery is fully charged)
Photos	Approximately 100 min/ Approximately 200 photos	<p>The battery life was measured under the following conditions: in Program mode, in darkness, 16m resolution, Fine quality, OIS on.</p> <ol style="list-style-type: none"> 1. Set the flash option to Fill in, take a single shot, and zoom in or out. 2. Set the flash option to Off, take a single shot, and zoom in or out. 3. Perform steps 1 and 2, waiting 30 seconds between each step. Repeat the process for 5 minutes, and then turn off the camera for 1 minute. 4. Repeat steps 1 to 3.
Videos	Approximately 70 min	Record videos at HD resolution and 30 FPS.

- The figures above are based on the CIPA test standards. Your results may differ depending on your actual usage.
- Several videos were recorded in succession to determine the total recording time.
- When using network functions, the battery will be depleted more quickly.

Low battery message

When the battery has fully discharged, the battery icon will turn red and the "**Low Battery**" message will appear.

Notes about using the battery

- Avoid exposing batteries to very cold or very hot temperatures (below 0 °C/32 °F or above 40 °C/104 °F). Extreme temperatures can reduce the charging capacity of your batteries.
- When you use the camera for an extended period, the area around the battery chamber may become warm. This does not affect the normal use of the camera.
- Do not pull the power supply cord to disconnect the plug from the power outlet, as this may cause a fire or electric shock.
- In temperatures below 0 °C/32 °F, battery capacity and battery life may decrease.
- Battery capacity may decrease in low temperatures but will return to normal in milder temperatures.
- Remove the batteries from your camera when storing it for an extended period. Installed batteries may leak or corrode over time and cause serious damage to your camera. Storing the camera for extended periods with the battery installed causes the battery to discharge. You may not be able to recharge a fully discharged battery.
- When you do not use the camera for an extended period (3 months or more), check the battery and recharge it regularly. If you let the battery discharge continually, its capacity and life may decrease, which can lead to a malfunction, fire, or explosion.

Cautions about using the battery

Protect batteries, chargers, and memory cards from damage

Prevent batteries from making contact with metal objects, as this can create a connection between the + and – terminals of your battery and lead to temporary or permanent battery damage and may cause a fire or electric shock.

Notes about charging the battery

- If the status lamp is off, make sure that the battery is inserted correctly.
- If the camera is on while charging, the battery may not fully charge. Turn off the camera before charging the battery.
- Do not use your camera when you are charging the battery. This may cause a fire or electric shock.
- Do not pull the power supply cord to disconnect the plug from the power outlet, as this may cause a fire or electric shock.
- Let the battery charge for at least 10 minutes before turning on the camera.
- If you connect the camera to an external power source when the battery is depleted, using high energy-consuming functions will cause the camera to turn off. To use the camera normally, recharge the battery.

- If you reconnect the power cable when the battery is fully charged, the status lamp turns on for approximately 30 minutes.
- Using the flash or recording videos depletes the battery quickly. Charge the battery until the red status lamp turns off.
- If the indicator light does not illuminate, reconnect the cable, or remove the battery and insert it again.
- Overcharging batteries may shorten battery life. After charging is finished, disconnect the cable from your camera.
- Do not bend or place heavy objects on the AC cable. Doing so may damage the cable.

Notes about charging with a computer connected

- Use only the provided USB cable.
- The battery may not charge when:
 - you use a USB hub
 - other USB devices are connected to your computer
 - you connect the cable to the port on the front side of your computer
 - the USB port of your computer does not support the power output standard (5 V, 500 mA)

Handling and disposing of batteries and chargers with care

- Never dispose of batteries in a fire. Follow all local regulations when you dispose of used batteries.
- Never place batteries or cameras on or in heating devices, such as microwave ovens, stoves, or radiators. Batteries may explode when they are overheated.



Personal injury or death can occur if the battery is handled carelessly or improperly. For your safety, follow these instructions for proper battery handling:

- The battery can ignite or explode if not handled properly. If you notice any deformities, cracks, or other abnormalities in the battery, immediately discontinue use of the battery and contact a service center.
- Use only authentic, manufacturer-recommended battery chargers and adapters and charge the battery only by the methods described in this user manual.
- Do not place the battery near heating devices or expose it to excessively warm environments, such as the inside of an enclosed car in the summertime.
- Do not place the battery in a microwave oven.
- Avoid storing or using the battery in hot, humid places, such as spas or shower enclosures.
- Do not rest the device on flammable surfaces, such as bedding, carpets, or electric blankets for a prolonged period.
- When the device is switched on, do not leave it in any confined space for a prolonged period.
- Do not allow battery terminals to come in contact with metallic objects, such as necklaces, coins, keys, or watches.
- Use only authentic, manufacturer-recommended, Lithium-ion replacement batteries.

- Do not disassemble or puncture the battery with any sharp object.
- Avoid exposing the battery to high pressure or crushing forces.
- Avoid exposing the battery to major impacts, such as dropping it from high places.
- Do not expose the battery to temperatures of 60 °C (140 °F) or above.
- Do not allow the battery to come in contact with moisture or liquids.
- Do not expose the battery to sources of excessive heat such as sunshine, fire, or the like.

Disposal guidelines

- Dispose of the battery with care.
- Do not dispose of the battery in a fire.
- Disposal regulations may differ by country or region. Dispose of the battery in accordance with all local and federal regulations.

Guidelines for charging the battery

Charge the battery only by the method described in this user manual. The battery can ignite or explode if not charged properly.

Upgrading Firmware

i-Launcher allows you to upgrade the firmware of your camera.

- 1 Rotate the mode dial to .
- 2 Select **Connectivity** → **i-Launcher** → **On**.
- 3 Turn off the camera.
- 4 Connect the camera to your computer with the USB cable.



You must plug the small end of the USB cable into your camera. If the cable is reversed, it may damage your files. The manufacturer is not responsible for any loss of data.

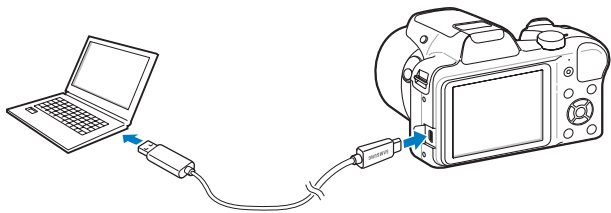

- 5 Turn on the camera.

- 6 Install i-Launcher on the PC.

OS	How to install
Windows	<p>When the pop-up window prompting you to install i-Launcher appears, select Yes.</p> <ul style="list-style-type: none"> • If a pop-up window prompting you to run iLinker.exe appears, run it first. • If the pop-up window prompting does not appear, click My Computer → i-Launcher → iLinker.exe. • When you connect the camera to a computer with i-Launcher installed, the program will launch automatically.
Mac	Click Devices → i-Launcher → Mac → iLinker .

- 7 Upgrade the firmware to the latest version following the on-screen instructions.

- Select **Firmware Upgrader** on the screen of i-Launcher.



- Before upgrading the firmware, ensure that the PC is connected to a network.
- Do not turn the camera off until the firmware upgrading is finished.

Before contacting a service center

If you are having trouble with your camera, try these troubleshooting procedures before you contact a service center. If you have attempted the suggested remedy and are still having problems with your device, contact your local dealer or service center.



When you leave your camera at a service center, be sure to also leave the other components that may have contributed to the malfunction, such as the memory card and battery.

Situation	Suggested remedies
Cannot turn on the camera	<ul style="list-style-type: none">• Ensure that the battery is inserted.• Ensure that the battery is inserted correctly. (p. 25)• Charge the battery.
The power turns off suddenly	<ul style="list-style-type: none">• Charge the battery.• Your camera may be in Auto Power Off mode. (p. 114)• The camera may turn off to prevent the memory card from being damaged due to an impact. Turn on your camera again.
The camera is losing battery power quickly	<ul style="list-style-type: none">• The battery may lose power more quickly in low temperatures (below 0 °C/32 °F). Keep the battery warm by putting it into your pocket.• Using the flash or recording videos depletes the battery quickly. Recharge if needed.• Batteries are consumable parts that must be replaced over time. Get a new battery if the battery life is diminishing quickly.

Situation	Suggested remedies
Cannot capture photos	<ul style="list-style-type: none">• There is no space on the memory card. Delete unnecessary files or insert a new card.• Format the memory card.• The memory card is defective. Get a new memory card.• Make sure that the camera is switched on.• Charge the battery.• Make sure that the battery is inserted correctly.
The camera freezes	Remove the battery and insert it again.
The camera heats up	While you use the camera, it may heat up. This is normal and should not affect your camera's lifespan or performance.
The flash does not work	<ul style="list-style-type: none">• The flash option may be set to Off. (p. 58)• You cannot use the flash in some modes.

Situation	Suggested remedies
The flash fires unexpectedly	The flash may fire due to static electricity. The camera is not malfunctioning.
The date and time are incorrect	Set the date and time in the display settings. (p. 113)
The display or buttons do not work	Remove the battery, and then insert it again.
The camera display responds poorly	If you use your camera at very low temperatures, it may cause the camera screen to malfunction or discolor. For better performance of your camera screen, use your camera in moderate temperatures.
The memory card has an error	<ul style="list-style-type: none"> • Turn off your camera, and then turn it on again. • Remove your memory card, and then insert it again. • Format your memory card. See "Cautions when using memory cards" for more detail. (p. 122)

Situation	Suggested remedies
Cannot play back files	If you change the name of a file, your camera may not play the file (the name of the file should meet the DCF standard). If you encounter this situation, play back the files on your computer.
The photo is blurry	<ul style="list-style-type: none"> • Make sure that the focus option you set is suitable for close-up shots. (p. 60) • Make sure that the lens is clean. If not, clean the lens. (p. 117) • Make sure that the subject is within range of the flash. (p. 132)
The colors in the photo do not match the actual scene	An incorrect White Balance can create unrealistic color. Select the proper White Balance option to suit the light source. (p. 69)
The photo is too bright or dark	Your photo is overexposed or underexposed. <ul style="list-style-type: none"> • Turn the flash off or on. (p. 58) • Adjust the ISO sensitivity. (p. 59) • Adjust the exposure value. (p. 67)

Situation	Suggested remedies
The TV does not display your photos	<ul style="list-style-type: none"> • Make sure that the camera is correctly connected to the TV with the A/V cable. • Make sure that your memory card contains photos.
Your computer does not recognize your camera	<ul style="list-style-type: none"> • Make sure that the USB cable is connected correctly. • Make sure that your camera is switched on. • Make sure that you are using a supported operating system.
Your computer disconnects the camera while transferring files	The file transmission may be interrupted by static electricity. Disconnect the USB cable and connect it again.
i-Launcher is not functioning properly	<ul style="list-style-type: none"> • End i-Launcher and restart the program. • Make sure that i-Launcher is set to On in the settings menu. (p. 112) • Depending on your computer's specifications and environment, the program may not launch automatically. In this case, click Start → All Programs → Samsung → i-Launcher → Samsung i-Launcher on your computer. (For Windows 8, click Start → All apps → Samsung i-Launcher.)

Situation	Suggested remedies
Your TV or computer cannot display photos and videos that are stored on a SDXC memory card.	SDXC memory cards use the exFAT file system. Ensure that the external device is compatible with the exFAT file system before connecting the camera to the device.
Your computer does not recognize a SDXC memory card.	SDXC memory cards use the exFAT file system. To use SDXC memory cards on a Windows XP computer, download and update the exFAT file system driver from the Microsoft website.

Camera specifications

Image sensor	
Type	1/2.3" (Approximately 7.73 mm) CCD
Effective pixels	Approximately 16.20 mega-pixels
Total pixels	Approximately 16.50 mega-pixels
Lens	
Focal length	Samsung Lens 35x Zoom Lens f = 4.5–157.5 mm (35 mm film equivalent: 25–875 mm)
F-stop range	F3.0 (W)–F5.9 (T)
Digital zoom	<ul style="list-style-type: none"> • Still image mode: 1.0~35.0X(Optical)/1.0~2.0X(Digital) • Playback mode: 1.0–14.4X (depending on image size) • Intelli zoom: 2.0X
Display	
Type	TFT LCD
Feature	3.0" (75.0 mm) 460K
Focusing	
Type	TTL Auto Focus (Center AF, Multi AF, Selection AF, Tracking AF, Face Detection AF)

Range		Wide (W)	Tele (T)
	Normal (AF)		31 in. (80 cm)–infinity
Macro		4-31 in. (10-80 cm)	59-138 in. (150-350 cm)
Auto Macro		0.4 in. (1 cm)–infinity	59 in. (150 cm)–infinity
Super Macro		0.4 in. (1 cm)	–

Shutter speed

- Auto: 1/8–1/2,000 sec.
- Program: 1–1/2,000 sec.
- Night: 8–1/2,000 sec.









Exposure

Control	Program AE
Metering	Multi, Spot, Center-weighted, Face Detection
Metering range	EV 1–17 (Wide, ISO Auto), EV 3–17 (Tele, ISO Auto)
Compensation	±2EV (1/3 EV Step)
ISO equivalent	Auto, ISO 80, ISO 100, ISO 200, ISO 400, ISO 800, ISO 1600, ISO 3200 (3M)

Flash	
Mode	Off, Auto, Red-eye, Fill in, Slow Sync, Red-eye Fix
Range	<ul style="list-style-type: none"> • Wide: 31-236 in. (0.8–6 m) (ISO Auto) • Tele: 59-118 in. (1.5 –3 m) (ISO Auto)
Recharging time	Approximately 5 sec.
Shake reduction	
Dual IS [OIS(Optical Image Stabilization) + DIS(Digital Image Stabilization)]	
Effect	
Photo Shooting mode	<ul style="list-style-type: none"> • Photo Filter (Smart Filter): Miniature, Vignetting, Fish-eye, Classic, Retro, Cross Filter • Image Adjust: Sharpness, Contrast, Saturation
Video Shooting mode	Movie Filter: Miniature, Vignetting, Fish-eye, Classic, Retro, Palette Effect 1, Palette Effect 2, Palette Effect 3, Palette Effect 4
White Balance	
Auto WB, Daylight, Cloudy, Fluorescent_H, Fluorescent_L, Tungsten, Custom Set, Color Temp.	
Date Imprinting	
Date & Time, Date, Off	

Shooting	
Photos	<ul style="list-style-type: none"> • Modes: Smart Auto (Portrait, Night Portrait, Night, Backlight Portrait, Backlight, Landscape, White, Macro, Macro Text, Tripod, Action, Macro Color, Natural Green, Blue Sky, Sunset, Low Light, Spot Light, Spot Light Macro, Spot Light Portrait), Program, Smart (Beauty Face, Action Freeze, Sunset, Landscape, Silhouette, Fireworks, Night, Macro, Light Trace), Panorama, Magic Plus (Photo Filter) • Burst: Single, Continuous, AEB, Motion Capture • Timer: Off, 10 Sec, 2 Sec, Double
Videos	<ul style="list-style-type: none"> • Modes: Movie, Magic Plus (Movie Filter) • Format: MP4 (H.264) (Max recording time: 20 min) • Size: 1280 X 720, 640 X 480, 320 X 240, 240 Web • Frame Rate : 30fps • Voice: On, Off, Zoom Mute

Playback	
Photos	<ul style="list-style-type: none"> Type: Single image, Thumbnails, Multi Slide Show with Music and Effect, Movie clip Edit: Resize, Rotate, Smart Filter, Crop Effect: Image Adjust (Brightness, Contrast, Saturation, ACB, Face Retouch, Red-eye Fix), Smart Filter (Normal, Miniature, Vignetting, Fish-eye, Classic, Retro, Cross Filter)
Videos	Video editing: Still image capture, Time trimming
Storage	
Media	<ul style="list-style-type: none"> External memory (Optional): SD card (2 GB guaranteed), SDHC card (up to 32 GB guaranteed), SDXC card (up to 64 GB guaranteed) - Class 6 and above recommended
File format	<ul style="list-style-type: none"> Still Image: JPEG (DCF), EXIF 2.3 Movie Clip: MP4 (Video: MPEG4, AVC/H.264, Audio: AAC)

Image size	Icon	Size
		4608 X 3456
	4608 X 3072	
	4608 X 2592	
	3648 X 2736	
	2832 X 2832	
	2592 X 1944	
	1984 X 1488	
	1920 X 1080	
	1024 X 768	

Wireless network

MobileLink, Remote Viewfinder, SNS & Cloud, Email, S/W Upgrade Notifier, Samsung Link, AutoShare

NFC

Yes

Camera specifications

Interface	
Digital output connector	USB 2.0
Audio input/output	Internal speaker (Mono), Microphone (Mono)
Video output	A/V: NTSC, PAL (selectable)
DC power input connector	5.0 V

Power source	
Rechargeable battery	Lithium-ion battery (SLB-10A, 1030 mAh)
Connector type	Micro USB (5 pin)

The power source may differ depending on your region.

Dimensions (W X H X D)
4.9 X 3.4 X 3.6 in. (124.5 X 86.5 X 92.0 mm) (without protrusions)

Weight
16.4 oz. (464 g) (without battery and memory card)

Operating Temperature
0–40 °C (32–104 °F)

Operating Humidity
5–85 %

Software
i-Launcher

Specifications may change without notice to improve performance.

Glossary

ACB (Auto Contrast Balance)

This feature automatically improves the contrast of your images when the subject is backlit or when there is a high contrast between your subject and the background.

AEB (Auto Exposure Bracket)

This feature automatically captures several images at different exposures to help you capture a properly-exposed image.

AF (Auto Focus)

A system that automatically focuses the camera lens on the subject. Your camera uses the contrast to focus automatically.

Aperture

The aperture controls the amount of light that reaches the camera's sensor.

Camera shake (Blur)

If the camera is moved while the shutter is open, the entire image may appear blurred. This occurs more often when the shutter speed is slow. Prevent camera shake by raising the sensitivity, using the flash, or using a faster shutter speed. Alternately, use a tripod, the DIS or OIS function to stabilize the camera.

Composition

Composition in photography means arranging objects in a photo. Usually, abiding by the rule of thirds leads to a good composition.

DCF (Design rule for Camera File system)

A specification to define a file format and file system for digital cameras created by the Japan Electronics and Information Technology Industries Association (JEITA).

Depth of field

The distance between the nearest and farthest points that can be acceptably focused in a photograph. Depth of field varies with lens aperture, focal length, and distance from the camera to the subject. Selecting a smaller aperture, for example, will increase the depth of field and blur the background of a composition.

Digital zoom

A feature that artificially increases the amount of zoom available with a zoom lens (Optical zoom). When using the Digital zoom, the image quality will deteriorate as the magnification increases.

DIS (Digital Image Stabilization)

This feature compensates in real-time for shaking and vibrating while shooting. There can be a certain amount of image degradation compare to Optical Image Stabilization.

EV (Exposure Value)

All the combinations of the camera's shutter speed and lens aperture that result in the same exposure.

EV Compensation

This feature allows you to quickly adjust the exposure value measured by the camera, in limited increments, to improve the exposure of your photos. Set the EV compensation to -1.0 EV to adjust the value one step darker and 1.0 EV to one step brighter.

Exif (Exchangeable Image File Format)

A specification to define an image file format for digital cameras created by the Japan Electronic Industries Development Association (JEIDA).

Exposure

The amount of light allowed to reach the camera's sensor. Exposure is controlled by a combination of the shutter speed, the aperture value, and ISO sensitivity.

Flash

A speed light that helps to create adequate exposure in low-light conditions.

Focal length

The distance from the middle of the lens to its focal point (in millimeters). Longer focal lengths result in narrower angles of view and the subject is magnified. Shorter focal lengths result in wider angles of view.

Histogram

A graphical representation of the brightness of an image. The horizontal axis represents the brightness and the vertical axis represents the number of pixels. High points at the left (too dark) and right (too bright) on the histogram indicate a photo that is improperly exposed.

H.264/MPEG-4

A high-compression video format established by international standard organizations ISO-IEC and ITU-T and developed by the Joint Video Team (JVT). This codec is capable of providing good video quality at low bit rates.

Image sensor

The physical part of a digital camera that contains a photosite for each pixel in the image. Each photosite records the brightness of the light that strikes it during an exposure. Common sensor types are CCD (Charge-coupled Device) and CMOS (Complementary Metal Oxide Semiconductor).

ISO sensitivity

The sensitivity of the camera to light, based on the equivalent film speed used in a film camera. At higher ISO sensitivity settings, the camera uses a higher shutter speed, which can reduce blur caused by camera shake and low light. However, images with high sensitivity are more susceptible to noise.

JPEG (Joint Photographic Experts Group)

A lossy method of compression for digital images. JPEG images are compressed to reduce their overall file size with minimal deterioration of the image resolution.

LCD (Liquid Crystal Display)

A visual display commonly used in consumer electronics. This display needs a separate backlight, such as CCFL or LED, to reproduce colors.

Macro

This feature allows you to capture close-up photos of very small objects. When using the macro feature, the camera can maintain a sharp focus on small objects at a near life-size ratio (1:1).

Metering

The metering refers to the way in which the camera measures the quantity of light to set the exposure.

MJPEG (Motion JPEG)

A video format which is compressed as a JPEG image.

NFC (Near Field Communication)

NFC is a set of standards for radio communication at very close proximity. You can use NFC-enabled devices to activate features or exchange data with other devices.

Noise

Misinterpreted pixels in a digital image that may appear as misplaced or random, bright pixels. Noise usually occurs when photos are shot with a high sensitivity or when a sensitivity is automatically set in a dark place.

Optical zoom

This is a general zoom which can enlarge images with a lens and does not deteriorate quality of images.

Quality

An expression of the rate of compression used in a digital image. Higher quality images have a lower rate of compression, which usually results in a larger file size.

Resolution

The number of pixels present in a digital image. High resolution images contain more pixels and typically show more detail than low resolution images.

Shutter speed

Shutter speed refers to the amount of time it takes to open and close the shutter, and it is an important factor in the brightness of a photo, as it controls the amount of light which passes through the aperture before it reaches the image sensor. A fast shutter speed allows less time to let light in and the photo becomes darker and more easily freezes subjects in motion.

Vignetting

A reduction of an image's brightness or saturation at the periphery (outer edges) compared to the center of the image. Vignetting can draw interest to subjects positioned in the center of an image.

White balance (color balance)

An adjustment of the intensities of colors (typically the primary colors red, green, and blue) in an image. The goal of adjusting the white balance, or color balance, is to correctly render the colors in an image.



**Correct Disposal of This Product
(Waste Electrical & Electronic Equipment)**

(Applicable in countries with separate collection systems)

This marking on the product, accessories, or literature indicates that the product and its electronic accessories (e.g. charger, headset, USB cable) should not be disposed of with other household waste at the end of their working life. To prevent possible harm to the environment or human health from uncontrolled waste disposal, please separate these items from other types of waste and recycle them responsibly to promote the sustainable reuse of material resources.

Household users should contact either the retailer where they purchased this product or their local government office for details of where and how they can take these items for environmentally safe recycling.

Business users should contact their supplier and check the terms and conditions of the purchase contract. This product and its electronic accessories should not be mixed with other commercial wastes for disposal.



PlanetFirst represents Samsung Electronics' commitment to sustainable development and social responsibility through eco-driven business and management activities.



Correct disposal of batteries in this product

(Applicable in countries with separate collection systems)

This marking on the battery, manual, or packaging indicates that the batteries in this product should not be disposed of with other household waste at the end of their working life. Where marked, the chemical symbols Hg, Cd, or Pb indicate that the battery contains mercury, cadmium, or lead above the reference levels in EC Directive 2006/66. If batteries are not properly disposed of, these substances can cause harm to human health or the environment.

To protect natural resources and to promote material reuse, please separate batteries from other types of waste and recycle them through your local, free battery return system.

CAN ICES-3 (B)/NMB-3(B)

Dispose unwanted electronics through an approved recycler.
To find the nearest recycling location, go to our website:
www.samsung.com/recyclingdirect Or call, (877) 278 - 0799



This device complies with Part 15 of the FCC Rules. Operation is subject to the following two conditions: (1) This device may not cause harmful interference, and (2) this device must accept any interference received, including interference that may cause undesired operation.

This equipment has been tested and found to comply with the limits for a Class B digital device, pursuant to Part 15 of the FCC Rules. These limits are designed to provide reasonable protection against harmful interference in a residential installation. This equipment generates, uses and can radiate radio frequency energy and, if not installed and used in accordance with the instructions, may cause harmful interference to radio communications. However, there is no guarantee that interference will not occur in a particular installation.

If this equipment does cause harmful interference to radio or television reception, which can be determined by turning the equipment off and on, the user is encouraged to try to correct the interference by one of the following measures:

- Reorient or relocate the receiving antenna.
- Increase the separation between the equipment and receiver.
- Connect the equipment into an outlet on a circuit different from that to which the receiver is connected.
- Consult the dealer or an experienced radio/TV technician for help.

FCC Caution: Any changes or modifications not expressly approved by the party responsible for compliance could void the user's authority to operate this equipment.

This transmitter must not be co-located or operating in conjunction with any other antenna or transmitter.

Radiation Exposure Statement:

The product comply with the FCC portable RF exposure limit set forth for an uncontrolled environment and are safe for intended operation as described in this manual. The further RF exposure reduction can be achieved if the product can be kept as far as possible from the user body or set the device to lower output power if such function is available.

IC: 649E-WB1100F



This device complies with RSS-210 of the Industry Canada Rules. Operation is subject to the following two conditions: (1) This device may not cause harmful interference, and (2) this device must accept any interference received, including interference that may cause undesired operation.

Ce dispositif est conforme à la norme CNR-210 d'Industrie Canada applicable aux appareils radio exempts de licence. Son fonctionnement est sujet aux deux conditions suivantes: (1) le dispositif ne doit pas produire de brouillage préjudiciable, et (2) ce dispositif doit accepter tout brouillage reçu, y compris un brouillage susceptible de provoquer un fonctionnement indésirable.

FOR PORTABLE DEVICE USAGE (<20m from body/SAR needed)

Radiation Exposure Statement:

The product comply with the Canada portable RF exposure limit set forth for an uncontrolled environment and are safe for intended operation as described in this manual. The further RF exposure reduction can be achieved if the product can be kept as far as possible from the user body or set the device to lower output power if such function is available.

Déclaration d'exposition aux radiations:

Le produit est conforme aux limites d'exposition pour les appareils portables RF pour les Etats-Unis et le Canada établies pour un environnement non contrôlé.

Le produit est sûr pour un fonctionnement tel que décrit dans ce manuel. La réduction aux expositions RF peut être augmentée si l'appareil peut être conservé aussi loin que possible du corps de l'utilisateur ou que le dispositif est réglé sur la puissance de sortie la plus faible si une telle fonction est disponible.

IC: 649E-WB1100F

• Declaration of Conformity

Trade Name	: Samsung Electronics America, Inc.
Model No.	: Samsung WB1100F
Responsible Party	: Samsung Electronics America, Inc.
Address	: 85 Challenger Road, Ridgefield Park, NJ 07660
Telephone No.	: 1-800-SAMSUNG (726-7864)

This device complies with Part 15 of the FCC Rules.

Operation is subject to the following two conditions:

(1) This device may not cause harmful interference, and (2) this device must accept any interference received, including interference that may cause undesired operation.

Index

A

- AF-assist light
 - location 21
 - Settings 114
- AF Lamp 114
- AF Sound 111
- Auto Contrast Balance (ACB)
 - Playback mode 85
 - Shooting mode 68
- Auto Display Off 112
- Auto Exposure Bracket (AEB) 71
- AutoShare 98
- A/V port 21

B

- Battery
 - Caution 124
 - Charging 26
 - Inserting 25
- Beauty Face 47
- Blink Detection 65
- Brightness
 - Playback mode 85
 - Shooting mode 67
- Burst modes
 - Auto Exposure Bracket (AEB) 71
 - Continuous 71
 - Motion Capture 71

C

- Camera maintenance 117
- Camera specifications 131
- Capturing an image from video 87
- Charging 26
- Cleaning
 - Camera body 117
 - Display 117
 - Lens 117
- Connecting to a computer
 - Mac 90
 - Windows 89
- Contrast
 - Playback mode 85
 - Shooting mode 72

D

- Date/Time Set 113
- Deleting files 78
- Digital zoom 38
- DIRECT LINK button 21
- Disconnecting the camera 89
- Display brightness 112
- Display type 35

E

- Editing photos 83
- Editing videos
 - Capturing 87
 - Trimming 87

Email 102
Enlarging 79
Error messages 116
Exposure 67

F

Face Detection 64
Flash
 Auto 58
 Fill in 58
 Off 58
 Red-eye 58
 Red-eye Fix 59
 Slow Sync 58

Focus area
 Center AF 61
 Multi AF 61
 Selection AF 61
 Tracking AF 61

Formatting 114

G

Guide Line 111

H

Half-press shutter 41

I

Icons

 Playback mode 75
 Shooting mode 29

i-Launcher 127

Image Adjustment

 ACB 85
 Brightness
 Playback mode 85
 Shooting mode 67

 Contrast
 Playback mode 85
 Shooting mode 72

 Red-eye 86

 Saturation
 Playback mode 85
 Shooting mode 72

 Sharpness 72

Image quality 55

Imprint 114

Intelli zoom 39

ISO sensitivity 59

L

Language settings 113

M

Macro

 Auto Macro 61
 Macro 61
 Super Macro 61

Magic Plus mode

 Movie Filter 51
 Photo Filter 50

Memory card

- Caution 122
- Insert 25

Menu button 23

Metering

- Center-weighted 68
- Multi 68
- Spot 68

MobileLink 99

Movie mode 52

N

NFC 97

O

- Open source licenses 114
- Optical Image Stabilization (OIS) 40
- Optional accessories 20

P

- Panorama mode 48
- Playback button 23
- Playback mode 75
- POWER button 21
- Program mode 46
- Protecting files 78

Q

- Quick view 112

R

- Red-eye
 - Playback mode 86
 - Shooting mode 57
- Remote Viewfinder 100
- Reset 114
- Resolution
 - Playback mode 83
 - Shooting mode 54
- Retouching faces 86
- Rotating 83

S

- Samsung Link 107
- Saturation
 - Playback mode 85
 - Shooting mode 72
- Self portrait 64
- Service center 128
- Settings 113
- Sharing service
 - Accessing 105
 - Uploading photos or videos 105
- Sharpness 72
- Shooting portraits
 - Blink Detection 65
 - Face Detection 64
 - Red-eye 58
 - Red-eye fix 59
 - Self portrait 64
 - Smile Shot 65

Shutter button 21
Slide show 81
Smart Auto mode 44
Smart Filter
 Photo shooting mode 50
 Playback mode 84
 Video recording mode 51
Smart mode 47
Smile Shot 65
Sound settings 36
Start Image 111
Status lamp 22

T
Thumbnails 76
Timer
 Shooting mode 56
 Timer lamp 21
Time settings 27
Time zone settings 27, 113
Transferring files
 Email 102
 Mac 90
 Windows 89
Tripod mount 22

U
Unpacking 20
USB port 21

V
Video
 Playback mode 82
 Shooting mode 52
Video out 112
Viewing files
 Category 77
 Panoramic photos 80
 Slide show 81
 Thumbnails 76
 TV 88

W
White Balance 69
Wireless network 93

Z
Zoom
 Using the zoom 38
 Zoom button 22
 Zoom sound settings 73



Please refer to the warranty that came with your product or visit our website www.samsung.com for after-sales service or inquiries.

CE 0678