

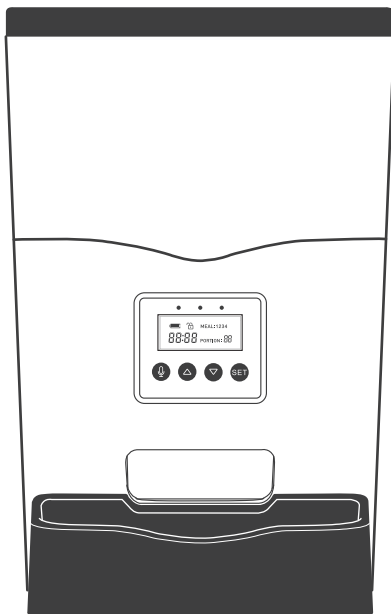

# Automatic Pet Feeder

## User Guide



Model: YM-AF001

Please read this User Guide before using the product and retain for reference.

# Safety Precautions

## WARNING

- Dispose of all packaging materials properly. Some items may be packed in polybags; these bags could cause suffocation; keep away from children and pets.
- DO NOT allow small children to play with, in or around the pet feeder.
- To reduce the risk of injury, please keep close supervision when an appliance is used near children.
- DO NOT use the feeder with pets not able to reach the food tray or with any physical disability.
- DO NOT immerse the base part in water at any time as it may damage electronic components like the control panel.
- DO NOT place any foreign object in the pet feeder.
- DO NOT use outdoors. Check operation frequently to be sure the unit is dispensing properly.
- DO NOT use wet, canned or moist food.
- DO NOT disassemble the unit other than as instructed in this User Guide.
- DO NOT use the feeder for anything other than its intended use.
- Only use attachments recommended or sold by the manufacturer. The use of attachments not recommended or sold by the manufacturer may cause an unsafe condition. Do not modify the pet feeder.
- DO not operate any appliance if the unit is malfunctioning or has been damaged. Do not attempt repairs on the pet feeder yourself. Contact our customer service immediately for further instructions.
- Always unplug when not in use and before cleaning.
- Never pull on the electrical power cord to remove the plug from the wall outlet.
- If the plug of this device gets wet, turn off electricity to that wall outlet. Do not attempt to unplug.
- Examine the feeder after installation. Do not plug in if there is water on the power cord or plug.
- To avoid tripping, always position power cord out of the way of foot traffic.

## CAUTION

- DO NOT allow pets to chew on or swallow any parts. If you are concerned about the power cord, purchase a cord conduit (a hard plastic protector) at any hardware store to protect the power cord.
- If an extension cord is necessary, one unit with a proper rating should be used.
- DO NOT install or store the pet feeder where it will be exposed to weather or temperatures below 4°C/ 39°F.
- Use alkaline D batteries to power. Do NOT use rechargeable batteries.
- Check the batteries regularly. Before leaving for extended time, always replace batteries with new ones.
- DO NOT lift the pet feeder by lid, food tank, or food tray. Lift and carry it using both hands and the base, while keeping the unit in an upright position.
- Suitable for dry food ONLY, with kibble size ranging from 2-10mm / 0.07-0.4in in diameter. Larger kibble may get stuck at the food outlet.
- Read and observe all important notices listed on the pet feeder and in the packaging.

# Product Diagram

## Front View

- 1. Lid Grip
- 2. Lid
- 3. Food Tank
- 4. LCD Screen
- 5. Control Panel
- 6. Food Outlet
- 7. Base
- 8. Food Tray

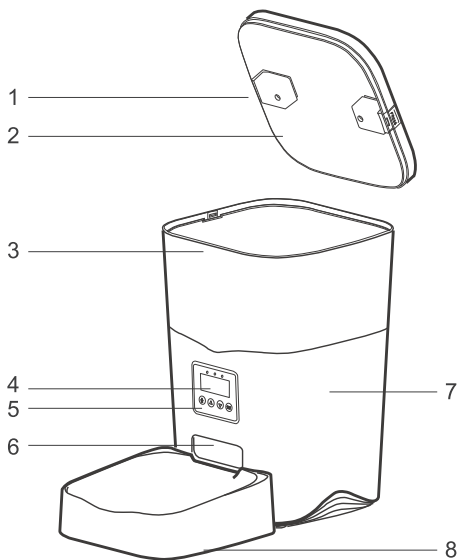

## Bottom View

- 10. Speaker
- 11. Battery Compartment
- 12. Power Socket

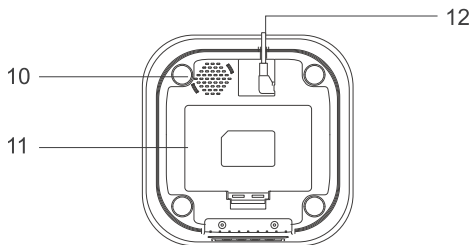

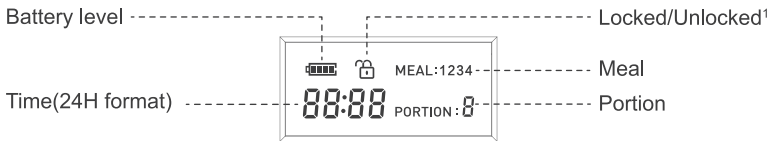

# Screen Details



## Button Function

 Press and hold for 3s until a beep is heard. Release, record (max 10s) and press again to end as a double beep is heard. Repeat to record a new audio.

 Press to increase value.  
Press and hold for 10s when screen off to reset all settings.

 Press to decrease value.  
Press and hold for 3s to unlock.

 Press to enter the setting menu and switch between time, meal, and portion settings, and when the specific icon blinks on the Screen indicating it's ready setting.

**Note:** Automatically lock the screen after 30s of standby.

# Cleaning & Care

It's recommended to clean the feeder regularly for the health of your pet.

When the food tank starts getting dirty and there is a lot of loose food at the bottom of the food tank, you can remove the food cover for cleaning.

Use a soft damp cloth to clean the feeder base which contains the control panel.

Never get this part wet and DO NOT wash with running water.

You can wash the Food Cover in warm soapy water. DO NOT put the product in the dishwasher, or it will be permanently damaged!

# What's in the box

1 x Automatic Pet Feeder

1 x 5V Power Adapter

1 x User Guide Kit

# Ymiko Automatic Pet Feeder

Model: YM-AF001

**Address:** Bldg 1-101, TOD Tech Center, Lipu Rd 7  
Dafapushequ, Bantian St., Longgang Dist.,  
Shenzhen, China

✉ E-mail: [ftvservice365@gmail.com](mailto:ftvservice365@gmail.com)



# How To Use

**Warning:** Please use the original 5V power supply

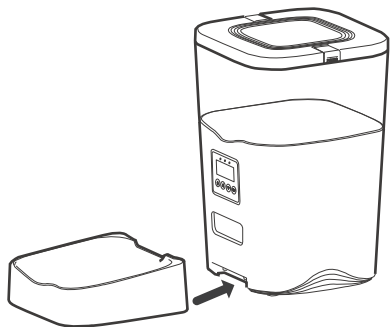

## 1. Assembling

- Removing feeder from box and packaging.
- Place the feeder in a desired location.
- Align the bulging of the food tray and holes in the base, and push upward to connect the two.

### **Note:**

Dispose of all packaging materials properly. Some items may be packed in polybags; these bags could cause suffocation; keep away from children and pets.

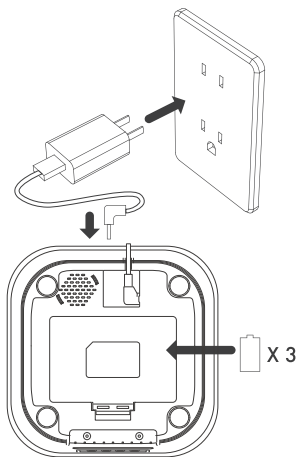

## 2. Connecting Power

- Insert the 5V power adapter into a wall socket. Plug in the power socket of the feeder.
- Open the battery compartment at the bottom of the unit, and install 3 alkaline D batteries (not included) in case of outage.
- The LCD display will light up automatically indicating the feeder is on now.

### **Note:**

- 1) Battery NOT included.
- 2) Before connecting to power, make sure all parts are clean and completely dry.

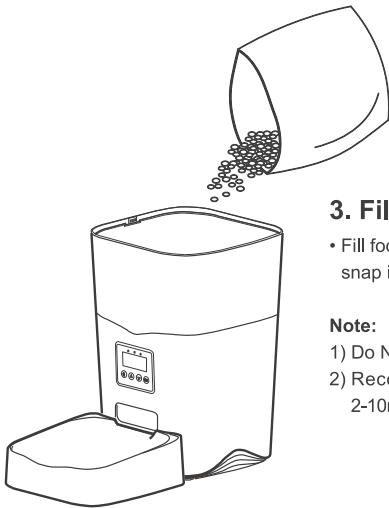

### 3. Filling Food Tank







- Fill food tank with dry pet food. Close the lid and it will snap into place due to gravity.

#### Note:

- 1) Do NOT use canned, wet or moist pet food.
- 2) Recommend kibble size ranging from 2-10mm/0.07-0.4in in diameter.





### 4. Setting the Time

- Press and hold the Unlocked button  3s to unlock the screen.
- Press and hold the Set button  for 3s to, and the Time icon  will blink the hour field.
- Press the Up / Down buttons  /  to scroll through numbers to set the hour.
- Press the Set button  to move to the minute field, set the minute similarly.



### 5. Setting the Meals Per Day

- After the current time is set, press the Set button , and the LCD display will show the current time and blink the Meal number. Press the Up / Down buttons  /  to set 1-4 meals per day.















## 6. Setting the Time & Portion of Meals

- After the meal number is set, the LCD display will blink the current Meal number. E.g., the meal number now is blinking "1", indicating it's ready for settings of the first meal.

### - Setting the time of the current meal



- Press the Set button  and the hour field of the Time icon will blink.
- Press the Up / Down button  /  buttons to set the hour.
- Press the Set button  and Up / Down  /  buttons to set the minute in the similar way.

### - Setting the portion of the current meal

- Press the Set button  and the Portion number will blink.
- Press the Up / Down button  /  buttons set the portion on the desired volume of the current meal to be dispensed.
- Press the Set button  to repeat the process above for the 2nd to 4th meal if needed.



## 7. Recording a Meal Call

- Press and hold the Record button  for 3s until a beep is heard.
- Record your voice for less than 10s, press the Record button  again to save. 2 beeps will be heard indicating it's saved. You can press the Record button to check the voice you just recorded.
- Repeat the process to change your recordings every time.

### Note:

- 1) Only press and play the recording if there's any.
- 2) When feeding time is up, the recording will be played after food is dispensed.



## 8. Manually Feeding Your Pet

- Press the ▲ & ▼ button at the same time when the screen is unlocked and one portion will be fed each time.

**Note:**

The normal schedule and portion will not be affected.



## 9. Reset All Settings

Press and hold the Up button ▲ for 10s when screen off to reset all settings (time, meals per day and time & portion of meals).

**Note:**

The voice record can't be reset and repeat the process of Recording a Meal Call to change your recordings every time.

# Troubleshooting

Problem	Solution
I can't press any buttons	The screen is locked when there's no operation in 30s. Please press and hold the Unlocked button for 3s to unlock the screen.
I can't remember the meal settings	Unlock the screen, press the Set button and you can see the meal number shown (but not the portion for each meal).
The food won't come out	<ol style="list-style-type: none"><li>1) Please be sure to fill in with dry food; kibble size should range from 2-10mm / 0.07-0.4in in diameter.</li><li>2) Check whether , any foreign objects are placed - disassemble the food tank and check the chute. Also check the food outlet.</li><li>3) Check whether it's low battery level - whether the power adapter is connected or there is any outage when no battery is installed.</li></ol>
LCD display is off	<ol style="list-style-type: none"><li>1) The screen is locked and dark when there's no operation in 30s. Please press and hold the Unlocked button for 3s to unlock the screen.</li><li>2) Check whether the power adapter is connected.</li><li>3) Contact the support team at <a href="mailto:ftvservice365@gmail.com">ftvservice365@gmail.com</a> the display still won't light up when the appliance is well connected to power.</li></ol>
I can't disassemble the food tank	Please follow steps in Clean & Care
I can't hear any voice recordings when feeding	Make sure you've recorded successfully - unlock the screen, press the Record button to check. If no sound is heard, you may need to record again and be sure to save following instructions in the Recording a Meal Call section.
Food volume for each portion is not the same	The first few portions may vary and it doesn't mean a faulty equipment. After about 6 feedings it should be almost even.

# Specifications

Food Tank Capacity	3L
Screen	LCD screen
Power	DC 5V power adapter; 3 x alkaline D batteries
Power Adapter	AC110-240V input, DC 5V output
Working Current	Avg. 80mA
Operating Temperature	-30 °C -50 °C / -22°F - 122°F
External Socket	3.5mm power socket
Gross Weight	3.48Lbs/1.58kg
Dimensions	7.8*7.8*12.2in/19.8*19.8*31cm

## Warranty

We provide a 1-year warranty for this appliance. Please email our support team at **ftvservice365@gmail.com** if you have any questions, and attach your order ID in your email. We'll get back to you as quick as possible.