

ProMariner™

HEAVY DUTY RECREATIONAL SERIES

ProSport

Marine Battery Charger

ProMar Digital Performance Charging Inside



Global AC Input
Power Factor Corrected
100-260 VAC 50/60 Hz



Owner's Manual and Installation Guide

Model	Part No.	Volts	Amps	Banks	Cables	Size	AC In
ProSport6 PFC	43023	12	6	1	6'	7.125" x 7.25" x 2.75"	100-260
ProSport12 PFC	43026	12/24	12	2	6'	9.875" x 7.25" x 2.75"	100-260
ProSport20 PFC	43028	12/24	20	2	6'	12.125" x 7.25" x 2.75"	100-260
ProSport20Plus PFC	43029	12/24/36	20	3	6'	12.125" x 7.25" x 2.75"	100-260

IMPORTANT NOTICE

Please save and read all safety, operating and installation instructions before installing or applying AC power to your ProSport On-Board Marine Battery Charger.

Your Satisfaction is Important to Us!

Please call our Customer Care Department at +1-800-824-0524 from 8:30 am to 5pm Eastern Time for any service or installation assistance. Thank you - ProMariner Customer Care

PLEASE RECORD YOUR:

Model Number: _____ Serial Number: _____ Date of Purchase: _____

For use with Flooded (Lead-Acid), AGM and Gel Batteries. Not for use with 4D or 8D large capacity batteries.



Table of Contents

Introduction...	1
Important Safety Instructions...	2-7
General Overview...	8-9
General Operation...	10-12
Installation...	13-15
Wiring Diagrams...	16-22
Charging your Batteries...	23
Maintenance...	24
Troubleshooting...	25
Accessories...	26
Environment and disposal...	27
Warranty...	28

Important Charger Operation Note:

Once your new ProSport is installed and properly connected to batteries you will be ready to plug it in.

Please note the ProSport has a built-in self test feature that will also analyze all battery connections and batteries to determine your boats batteries are capable of being charged correctly. The self test is automatic and will take place everytime the unit is plugged into a 120/230 VAC outlet. The self test may take up to 2 minutes to complete.

During the self test the red charge mode indicator will be flashing. When completed if everything is connected properly and the batteries are OK and above 2.0 volts DC then the charger will register and illuminate the green system check OK indicator followed by a solid (non flashing) red charge mode LED illuminating indicating all batteries are being charged.

If the charger does not go into the charge mode with a solid (non flashing) red charge mode indicator and the system check OK indicator is not illuminated with a solid green LED then a red battery bank fault LED will illuminate identifying the battery(s) that have either a wiring fault present i.e. poor connection, a blown DC cable fuse, the DC cable is wired in reverse polarity, battery cable is wired across two batteries in series with a high DC overvoltage of 24V or the battery itself may be under 2.0 volts DC. In any of these cases refer to the troubleshooting section on page 25 of this manual.

INTRODUCTION

1

Introduction

Thank you from all of us at ProMariner and congratulations on your recent purchase of the ProSport On-Board Marine Battery Charger. Powered and designed by ProMariner, a leader in the marine charger industry for over 35 years. ProSport Generation 3 On-Board Marine Battery Chargers incorporate all-digital microprocessor control. Like no other, the new ProSport Series provides automatic installation feedback with its exclusive "System Check OK" and individual "Battery Bank Trouble" LED indicators, and also has the most advanced energy saving mode. After fully charging and conditioning batteries, ProSport's Energy Saver Mode will monitor and Auto Maintain batteries only when needed to maintain a full state of charge, resulting in maximum reserve power performance and lower AC power consumption and operating costs.

ProSport incorporates Distributed-On-Demand™ Charging technology, taking 100% of the available charging amps and distributing them to any one or combination of all batteries as needed for faster charging.

ProSport is 100% waterproof and shockproof, weighing 40% lighter than older technology epoxy filled chargers providing cooler operation and greater reliability. Each ProSport model has 2 digitally selectable charge profiles (a 3rd HPAGM profile on the ProSport 20 Dual Only) and all models include a once-a-month storage reconditioning mode for extending battery life.

ProMariner's Generation 3 ProSport Features Include:

ProMar Digital Technology Microprocessor and software controlled pulse charging technology delivering a 40% lighter design, cooler charger operation and faster charging.

System OK & Battery Bank Trouble Status Indicators Advanced technology eliminates time consuming troubleshooting by clearly indicating system and battery connections are OK or if a fault is present on a specific battery bank.

Digital Multi-Stage Performance Charging Fully charge and extend the life of your batteries. Automatically charges, conditions and safely maintains batteries on board for maximum time on the water.

Energy Saver Mode After fully charging and conditioning batteries, ProSport's Energy Saver Mode will monitor and Auto Maintain batteries only when needed, maintaining a full state of charge. This significantly reduces AC power consumption, lowers operating costs and maximizes reserve power performance.

Storage Recondition Mode During short or long-term storage, ProSport automatically reconditions all batteries on board once a month for maximum battery life and performance.

Distributed-On-Demand™ Technology Automatically charges and maintains your engine crank battery while distributing all remaining charging amps to house or trolling motor battery(s).

Digital LED Display and Battery Type Selector LED indicators for Charging, Conditioning and Auto Maintain modes in addition to AC Power and selected battery type (2 charge profiles to choose from and a 3rd HPAGM profile on the ProSport 20 Dual Only).

Built-in Quality & Safety Compact and rugged extruded aluminum design. Dual in-line DC safety fuses for trolling motor and house battery banks, built-in over-voltage, overload, over-temperature, reverse polarity and ignition protection.

Pre-wired for Easy Installation

2-Year Warranty

Important Safety Instructions



SAVE THESE INSTRUCTIONS

This manual contains important safety and operating instructions for the ProSport On-Board Marine Battery Charger.



CAUTION – To reduce the risk of injury, charge only Lead-acid type rechargeable batteries; Flooded (Lead-acid), Sealed (Lead-acid) and Gel (Gelled Electrolyte Lead- acid). Other types of batteries may burst, causing personal injury.

Use of attachments not recommended or sold by ProMariner may result in a risk of fire, electrical shock or personal injury.

EXTERNAL CONNECTIONS TO CHARGER SHALL COMPLY WITH THE UNITED STATES COAST GUARD ELECTRICAL REGULATIONS (33CFR183, SUB PART 1).

Before connecting your batteries or applying AC power, read all instructions and cautionary markings on the battery charger, cables, and batteries.



WARNING

To reduce the risk of injury to user or property; the user must read and understand the instruction manual and all warnings on the charger and batteries before use.



WARNING

RISK OF EXPLOSIVE GAS MIXTURE. Read instructions in manual before using charger.

1. Connect and disconnect battery leads only when supply cord is disconnected.
2. Do not overcharge battery - See Instruction Manual.
3. Do not smoke, strike a match, or cause a spark in vicinity of battery.
4. Use in well-ventilated area.
5. Refer to Instruction Manual for further details.



CAUTION

Risk of Electric Shock. **Connect only to properly grounded GFCI (ground fault circuit interrupt) protected outlets.**

Do not expose AC Power cord connection to rain or snow.

If cords or wires/cables become damaged return complete unit to ProMariner for service/repair immediately.



WARNING

1. WARNING - RISK OF EXPLOSIVE GASES.
 - a. WORKING IN THE VICINITY OF A LEAD-ACID BATTERY IS DANGEROUS. BATTERIES GENERATE EXPLOSIVE GASES DURING NORMAL BATTERY OPERATION. FOR THIS REASON, IT IS OF UTMOST IMPORTANCE THAT YOU FOLLOW THE INSTRUCTIONS EACH TIME YOU USE THE CHARGER.
 - b. To reduce risk of battery explosion, follow these instructions and those marked on the battery.
2. Use charger for charging a LEAD-ACID battery only. It is not intended to supply power to an extra-low-voltage electrical system or to charge dry-cell batteries. Charging dry-cell batteries may burst and cause injury to persons and property.
3. NEVER smoke, strike a match or cause a spark or flame in vicinity of battery.

SAFETY INSTRUCTIONS

3

Important Safety Instructions

4. NEVER charge a frozen, damaged or leaking battery.
5. Study all battery manufacturer's specific precautions such as removing or not removing cell caps while charging and recommended rates of charge.
6. Use of an attachment not recommended or sold by ProMariner may result in a risk of fire, electric shock, or injury to persons.
7. To reduce risk of damage to electric plug and cord, pull by plug rather than cord when disconnecting charger.
8. Extension cords should not be used unless absolutely necessary. Use of an improper extension cord could result in a risk of fire and electric shock. If an extension cord must be used make sure:
 - a. Pins on the plug of the extension cord are the same number, size and shape as those on the plug of the charger.
 - b. Use only a properly wired extension cord in good electrical condition.
 - c. Use an industrial grade / heavy duty UL or CSA approved and grounded extension cord. Check extension cord before use for damage, bent prongs, and cuts. Replace if damaged. Always make your extension cord connection on the charger side first. **After connecting the extension cord to the charger proceed to plug the extension cord into a nearby 120/230 VAC GFCI protected (Ground Fault Circuit Interrupt) outlet.** Below are manufacturer recommendations for the right size UL or CSA Approved grounded extension cord.
 - i. Up to 50 feet in length use a 3 conductor 18 AWG extension cord.
 - ii. 50 to 100 feet in length use a 3 conductor 16 AWG extension cord.
 - iii. 100 to 150 feet in length use a 3 conductor 14 AWG extension cord.
9. Do not operate charger if any protective AC and DC cable insulation, charging clamps, DC fuse holders and/or maintainer ring terminals have been damaged or compromised. Return the charger for service and repair to ProMariner immediately.
10. Do not operate the charger if it has received a sharp blow, direct hit of force, been dropped or otherwise damaged in any way. Return the charger for service and repair to ProMariner immediately.
11. Do not disassemble charger. Incorrect reassembly may result in a risk of electric shock or fire. If service or repair is required please call ProMariner customer service at +1-800-824-0524 between 8:30am-5pm (EST) Monday through Friday, or via www.promariner.com. Unauthorized attempts to service, repair or modify may result in a risk of electrical shock, fire or explosion and will void warranty.
12. To reduce risk of electric shock, unplug charger from outlet before attempting any maintenance or cleaning.
13. Do not expose AC power cord connection to rain or snow.

Important Safety Instructions

14. GROUNDING AND AC POWER CORD CONNECTION INSTRUCTIONS

- Charger should be grounded to reduce risk of electric shock. Charger is equipped with an electric cord having in equipment-grounding conductor and a grounding plug. The plug must be plugged into a **120/230 VAC GFCI protected (Ground Fault Circuit Interrupt) outlet** that is properly installed and grounded in accordance with all local codes and ordinances.

DANGER

Never alter AC cord or plug provided - If it will not fit outlet, have proper outlet installed by a qualified electrician. Improper connection can result in a risk of an electric shock.

- This battery charger is for use on a nominal 120-volt circuit, and has a grounding plug that looks like the plug illustrated in figure A. A temporary adapter, which looks like the adapter illustrated in figure B may be used to connect this plug to a two-pole receptacle as shown in figure B if a properly grounded outlet is not available. **The temporary adapter should be used only until a properly grounded GFCI protected outlet can be installed by a qualified electrician.**

DANGER

Before using adapter as illustrated, be certain that center screw of outlet plate is grounded. The green-colored rigid ear or leg extending from adapter must be connected to a properly grounded outlet - make certain it is grounded. If necessary, replace original outlet cover plate screw with a longer screw that will secure adapter ear or leg to outlet cover plate and make ground connection to grounded GFCI protected outlet.

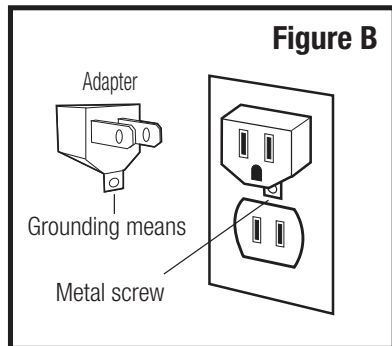
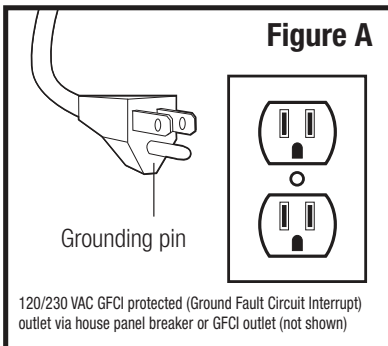

Use of an adapter is not allowed in Canada. If a grounding type receptacle is not available, do not use this appliance until the proper GFCI protected outlet is installed by a qualified electrician.

Important Safety Instructions

15. PERSONAL PRECAUTIONS

CAUTION

- a. Consider having someone close enough or within the range of your voice to come to your aid when you work near a lead-acid battery.
- b. Have plenty of soap, water and baking soda nearby in case battery acid comes in contact with skin, clothes or eyes.
- c. Wear complete eye protection, hand and clothing protection. Avoid touching eyes while working near a battery.
- d. If battery acid contacts skin or clothing, wash immediately with soap and water. If acid enters eye, immediately flood eye with running cold water for at least 15 minutes and get medical attention immediately.
- e. NEVER smoke, strike a match or cause a spark or flame in vicinity of battery or engine. f. Be extra cautious to reduce risk of dropping a metal tool onto the battery. It might spark or short-circuit a battery or other electrical hardware which may cause an explosion or fire.
- g. Remove all personal metal items such as rings, bracelets, necklaces, watches, and jewelry when working near a battery. A battery can produce a short circuit current high enough to weld a ring or any other metal, causing serious burns.
- h. Use charger for charging a LEAD-ACID battery only. It is not intended to supply power to a low voltage electrical system other than in a start-motor application. Do not use battery charger for charging dry-cell batteries that are commonly used with home appliances. These batteries may burst and cause injury to persons and damage to property.
- i. NEVER charge a frozen, damaged or leaking battery.
- j. Keep other persons, children and pets away from batteries and your charger during operation to avoid serious injury, death, fire or explosion.

Important Safety Instructions

16. PREPARING TO CHARGE A BATTERY

CAUTION

- a. If necessary to remove a battery from a boat to charge, **always remove the grounded negative terminal from the battery first**. Make sure all accessories in the boat are off, as to not cause an arc. Be sure the area around the charger and batteries is well ventilated while the batteries are being charged. Gases can be forcefully blown away using a piece of cardboard or other nonmetallic material as a fan.
- b. Be sure the area around the charger and batteries is well ventilated while the battery is being charged.

If the electrolyte is splashed into an eye, immediately force the eye open and flood it with clean, cool water for at least 15 minutes. Get prompt medical attention.

If electrolyte is taken internally, drink large quantities of water or milk. DO NOT induce vomiting. Get prompt medical attention.

Neutralize with baking soda any electrolyte that spills on a vehicle or in the work area. After neutralizing, rinse contaminated area clean with water.

- c. Clean battery terminals. Be careful to keep corrosion from coming in contact with eyes.
- d. For flooded batteries with removable caps, **ONLY ADD DISTILLED WATER** in each cell until electrolyte reaches levels specified by the battery manufacturer. Do not over fill. For a maintenance free battery without removable caps, such as valve regulated lead acid batteries, carefully follow manufacturer's recharging instructions.
- e. Study all battery manufacturers' specific precautions; warnings and instructions while charging and recommended rates of charge. Never charge a battery with missing safety vent caps.
- f. Do not overcharge batteries by selecting the wrong battery type or by trying to charge a non-12 Volt as defined by the 12 Volt battery types specified in this manual.

Always remove the extension cord from the 120/230 VAC outlet first when charging is completed followed by unplugging the charger, completely disconnecting.

SAFETY INSTRUCTIONS

7

Charger Location & DC Connection

17. CHARGER LOCATION

CAUTION

- a. Locate charger as far away from batteries as possible.
- b. Never place a charger directly above a battery being charged; gases or fluids from battery will corrode and damage charger.
- c. Do not operate charger in an enclosed area or in an area with restricted ventilation in any way.
- d. Never allow battery acid to drip on charger when reading electrolyte specific gravity or filling a battery.
- e. Do not set a battery on top of charger.
- f. Do not install on or over combustible surfaces.

18. DC CONNECTION PRECAUTIONS

CAUTION

- a. Connect and disconnect DC output cables only after setting any charger switches to “off” position and removing AC cord from electric outlet. Never allow cables to touch each other.

IMPORTANT NOTICE: FCC CLASS A PART 15 NOTIFICATION

Your On-Board Marine Battery Charger has been designed and tested to comply with FCC Class A part 15. These regulations are to provide adequate protection against harmful interference while operated in a commercial application. If in a residential setting, you are encountering interference with TV and radio reception, simply remove AC power from the ProMariner unit to confirm if your battery charger is causing interference. End user can explore the following to minimize interference:

- 1) Chose a different AC circuit to power your On-Board Marine Battery Charger.
- 2) Make sure your outlet is properly grounded.
- 3) Re-position receiving antenna.
- 4) Purchase a separate AC line filter.
- 5) Relocate charger so that it is at the furthest point from home receiving equipment, TV, radio, etc.



General Overview

The ProSport Charger is an advanced electronic and fully automatic multi-stage on-board marine battery charger. ProSport is pre-wired for easy installation and is 100% waterproof for fresh and salt water applications. ProSport's multi-stage charging process delivers five modes of operation that include: start up diagnostics, charging, conditioning, auto maintain and storage reconditioning of each battery. This process is proven to extend the life of your batteries and will fully charge your batteries each time you connect to AC power. ProSport delivers increased power and performance while providing improved durability and heat transfer.

The ProSport Distributed-On-Demand™ Charging Technology will automatically sense and distribute 100% of the available charging output of 8, 12, 15 or 20 amps (model specific) to any one battery or combination of all batteries. Each battery charger output is fully isolated. ProSport's easy to view LED indicators will provide at a glance status of: AC power, battery type, charging, and ready status. The LED status center also includes an indication of a fault or failure detected at each battery that is connected to the charger and can be seen on the top of the unit when installed.

Note: ProSport On-Board Marine Battery Chargers are designed for any combination of group 24, 27, 30 and 31 batteries. Each battery charger DC output cable must be connected to one (1) 12 Volt DC battery (even if batteries are configured for 24 Volt DC or 36 Volt DC trolling motor or system applications).

Important: The pair of red and black wires in 1 cable jacket MUST GO TO THE SAME 12VDC battery.

Each charger cable must be connected to 1 battery, just as shown. Observe black to (-) and red to (+). Do this for each battery.

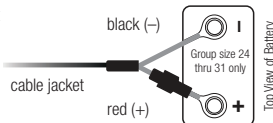

When connecting to an engine start battery only connect the battery bank cable that is LABELED: "FOR ENGINE BATTERY, USE THIS BANK CABLE ONLY".

Application Tip

If your application is for 4D or 8D large capacity batteries, please refer to ProMariner's website www.promariner.com and view our ProNauticP Hardwired Charger Assortment for a model that is correct for this group size of batteries.

Most specifically you do not have to remove series or parallel jumper cables to use your ProSport charger. See typical wiring diagrams for these systems in the installation section of this manual.

Note: The ProSport must be connected to batteries to operate. It will not operate as a 12 volt power supply.

GENERAL OVERVIEW

9

How Distributed-On-Demand™ Charging Technology Works

ProSport's Distributed-On-Demand™ Charging Technology ensures 100% of the available charging amps are fully utilized to meet the demand of each battery on-board. For example, if your engine start battery only needs 2 amps from your ProSport 12 (6/6 two bank charger) the unused 4 amps will be automatically Distributed-On-Demand™ to your house or trolling motor battery, providing a total of 10 amps for faster charging versus only 5 amps that the conventional 5/5 battery charger would provide. The competitive 5/5 charger has a 5 amp limit per bank.

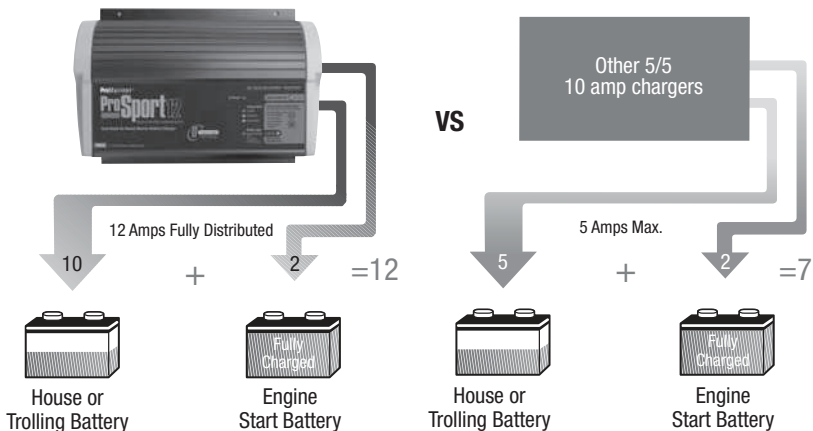

General Operation

Install your ProSport On-Board Marine Battery Charger to the guidelines in this manual.

Make sure your charger and batteries are properly vented. **Connect your extension cord with no AC power present to the ProSport and proceed to plug your extension cord in at a nearby 120/230 VAC GFCI protected (Ground Fault Circuit Interrupt) outlet.**

With your ProSport plugged in properly, it will automatically/fully charge your batteries while it conditions and extends the life of your batteries. Always leave your charger plugged in to reduce sulfate build-up allowing your batteries to be fully charged and maintained for your next fishing trip.

The ProSport design incorporates a new storage recondition mode that stimulates and reconditions your onboard batteries for 3 hours once a month and when completed will resume its normal auto maintain mode. During the storage recondition mode the ready/maintain LED will remain green and the storage recondition mode LED will fade-in fade-out pulse, indicating your batteries are being reconditioned and are fully charged during this process.

ProSport LED Status Center - Operation and Display

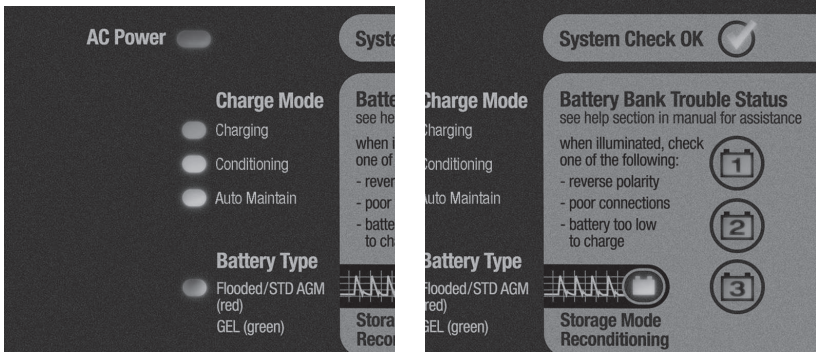

ProSport includes 7 LEDs for operation status and up to 3 battery bank trouble LEDs depending on the model.

1. The blue AC power LED

Illuminates when AC power is applied

2. The battery type LED

Will illuminate red for standard Flooded (lead-acid)/AGM and green for GEL.

Note: The ProSport 20 Dual bank model includes an amber battery type LED for AGM HP (High Performance) battery type. Please read the battery manufacturer literature carefully and select the correct charge profile. Failure to do so may cause early battery failure.

3. The system check OK LED

After applying AC power the ProSport will self test and analyze all battery connections and batteries. If all checks are OK the green LED will illuminate. This can take up to 2 minutes.

4. The charge mode LEDs

Charging: Red LED will flash during the self test and battery test mode (approximately 1-2 minutes) and will be solid red during charging.

Conditioning: Amber LED illuminates during conditioning mode.

Auto Maintain: Green LED illuminates when batteries are fully charged and being automatically maintained until you are ready to use your boat.

Storage Recondition: Green LED fades in and out when performing a once a month storage recondition mode.

5. Battery bank trouble status LEDs

Red LEDs will illuminate indicating a wiring problem or fault at one of the batteries connected to the ProSport charger. See page 25 for further details.

Operation after Applying AC Power to a ProSport Charger Connected to Discharged Batteries

(The following example is for the factory setting of Flooded (lead-acid) batteries) When power is applied the ProSport performs a self test of the battery charger electronics and the batteries connected to the battery charger.

During the startup test the battery type LED will be illuminated and the red charge mode LED will flash indicating that the unit is in a self test mode. When complete and if there are no faults, the charger's system check OK indicator will illuminate green and the ProSport's solid red charging LED will be ON indicating the charge process is initiated.

Note: If there is a fault the appropriate bank LED will illuminate and the charge process may not start, depending on the location of the fault. See page 25 for further troubleshooting details.

If there are no Battery Faults, the Green System Check OK LED will illuminate and the following sequences will proceed:

The red battery type LED (factory set for standard Flooded (lead-acid)/AGM batteries) will illuminate.

The red charge mode LED will illuminate indicating the charger has started its multi-stage charging process.

When the charge process is approximately 80% complete the red charge mode indicator will turn off and the amber conditioning LED will turn on indicating the conditioning mode.

When the multi-stage charge process is completed you will observe the following: Battery type red LED goes OFF.

The red charging LED and the amber conditioning LED will be off and the green ready/maintain LED will illuminate indicating your batteries are fully charged.

The only LEDs on after the multi-stage charge process is completed are the green system OK LED, blue AC power LED and the green ready/maintain LED.

Multi-Stage Charging Overview

Stage 1 - System Check OK and Battery Analyzing: During this stage the ProSport red "Charge" LED will flash indicating ProSport is analyzing all battery connections in addition to checking each battery is capable of being charged. Upon completion the "System Check OK" indicator will illuminate green followed by Stage 2 Charging.

Stage 2 - Charging: During this mode the "Charging" indicator will be red. The ProSport Series will use all of its available charging amps (as controlled by temperature) until the battery voltage is raised to 14.6 VDC (Flooded lead-acid factory setting).

Stage 3 - Conditioning: During this mode the "Conditioning" status indicator will be amber. Batteries will hold at 14.6 VDC (factory set for Flooded lead-acid batteries) to complete charging while conditioning each battery connected. Upon completion the ProSport will go into its Energy Saver Mode.

Stage 4 - Auto Maintain (Energy Saver Mode): During this mode the blue "Power" and green "Auto Maintain" LED's will be on indicating Stage 2 charging and Stage 3 conditioning are completed. At this time ProSport will initiate its Auto Maintain (Energy Saver Mode) which will monitor and Auto Maintain batteries only when needed to maintain a full state of charge.

Stage 5 - Storage Recondition Mode: During this mode the ProSport "Storage Recondition Mode" green indicator will illuminate with a slow fade in and out pulse. This indicates that while your batteries/boat are in storage the ProSport will automatically recondition all batteries for up to 3 hours once a month extending battery life and maximizing on the water battery power performance.

Average Voltage

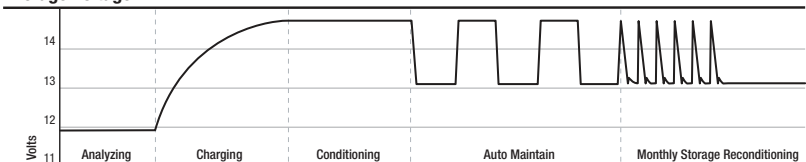

(Factory installed black programming cap charge profile illustration).

Selecting a Charging Profile & Understanding Battery Types

Your battery charger is equipped with a user programmable battery type selector that is factory set for standard Flooded (lead-acid) / AGM (Absorbed Glass Mat) batteries.

To set your charger for Gel batteries simply remove the black programming cap and replace it with the Gel programming gray cap. If you own a ProSport 20 Dual Bank Charger you also have the option to use the High Performance AGM profile recommended for OPTIMA BlueTop Deep Cycle and Odyssey AGM marine batteries by installing the blue AGM HP programming cap. Any time you reprogram or change the cap, apply marine silicone to the threads of the cap being installed.

NOTE: AGM (Absorbed Glass Mat) batteries are not Gel (Gelled Electrolyte Lead-acid) batteries. Gel batteries require a completely different charge profile that must be selected versus the out of the box factory setting. AGM batteries can accept the same charging profile as Flooded (lead-acid) batteries.

Understanding Battery Types & Charger Settings

There are three primary types of batteries in the marketplace today; standard Flooded (lead-acid), AGM (Absorbed Glass Mat), high performance AGM and Gel cell (Gelled Electrolyte Lead-acid). Traditionally, the most common type of batteries used are Flooded (lead-acid) batteries. Almost all Gel cell batteries will state that they are Gel cell on the battery case or labels. Shown below are typical battery voltages at absorption and float levels.

LED	Battery Type	Charging Profile	Cap
Red	Standard Flooded (lead-acid) - with or without fill caps AGM (Absorbed Glass Mat) - Sealed	14.6 VDC Absorption, 13.4 VDC Float	Black
Green	Gel Cell - Sealed Gray Cap	14.1 VDC Absorption, 13.8 VDC Float	Gray
Amber*	AGM High Performance (Absorbed Glass Mat) - Sealed (OPTIMA, Odyssey, West Marine Brands)	14.7 VDC Absorption 13.6 VDC Float	Blue*

NOTE: AGM (Absorbed Glass Mat) batteries are not Gel (Gelled Electrolyte Lead-acid) batteries. Gel batteries require a completely different charge profile that must be selected versus the out of the box factory setting. AGM batteries can accept the same charging profile as Flooded (Lead-acid) batteries.

* Only available on ProSport 20 Two Bank model only.

Note: If you are still unsure what kind of battery(s) you have, we recommend that you contact the manufacturer of the battery(s).

INSTALLATION

13

Installation

All ProSport Battery Chargers are designed to be permanently mounted on-board, and should be mounted with extruded fins placed horizontally.

Always mount your ProSport in a compartment area that can be properly ventilated during use.

Do NOT mix battery types on-board. All batteries should be of the same age and in good operating condition.

Do NOT make any electrical connections to the ProSport or batteries until the following steps are completed:

10 Easy to follow installation steps:

1. Select a mounting location that allows for free air ventilation with a minimum of 8 inches of clear unobstructed space around and in front of the battery charger. Open all battery and engine compartments and ventilate for at least 15 minutes before starting the installation of the charger. Confirm all battery cables can reach each of the batteries.

Do not install charger on carpeted, upholstered, vinyl, or varnished areas. Be sure to place the ProSport in an accessible area where all indicators are viewable. Install this unit on a hard surface.

Note: For installations requiring an extension of the DC battery charger cables, please call or visit your retailer or dealer to purchase ProMariner's 5 foot or 15 foot battery charger DC cable extenders. Our innovative cable extenders are properly fused and do not require any cutting or stripping of wires. If you have any problems locating this accessory call ProMariner at +1-800-824-0524.

2. Using the ProSport charger as a template or the enclosed paper template, mark the position of each mounting hole. Insure the mounting screws will not puncture or protrude into a live well, a fuel or oil tank or the bottom of the boat.

3. Using a 1/8" drill bit, drill pilot holes in the (4) marked locations as described in step 2. Apply a silicon sealer in each of the mounting locations to waterproof the screw holes.

4. Position the charger over the mounting holes and secure with a power screwdriver by installing 4 stainless steel # 10 screws. (mounting screws not included).

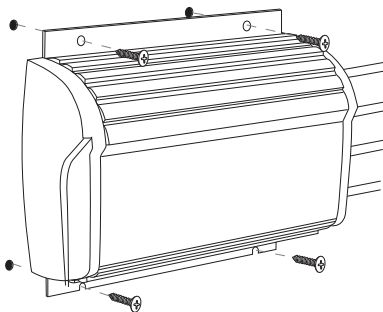

1/8" pilot hole
with silicon sealer

IMPORTANT NOTICE

Confirm the surface you will be mounting the charger to is adequate in strength and thickness to hold the ProSport in place with the mounting screws you have selected.

Maintain an obstruction free area of 8 inches around the ProSport On-Board Marine Battery Charger

For aluminum boat installation we recommend installing your ProSport Charger on a wood or fiberglass panel and not directly on the aluminum hull.

Installation

5. Prepare each battery in advance by cleaning each terminal post with a wire brush until a shiny surface is obtained.
6. Run cables free from sharp objects and hold each in place with cable ties. Coil excess cable, do not cut or shorten the length of the cables, as in-line fuses are located 4 inches from the end of each positive (red) cable. In addition, there are fuses in all but one of the negative (black) leads. These fuses protect the charger and output cables in the event of a wiring short. We recommend the use of wire ties or cable clamps to provide strain relief for the cables and to reduce the risk of damage to the cables or connections.
7. Connect the DC output cables as illustrated on pages 16-22. Make sure the (black) wires are connected as illustrated to the negative side of the battery and the (red) wires are connected to the positive side of the battery.

Important Note: Your ProSport charger will not operate properly if it is not connected properly to each battery. Reminder, The ProSport and each DC jacketed bank cable must be properly connected to "individual 12V batteries". Number of DC jacketed bank cables equals the number of batteries that must be individually connected. Example: a 3 bank ProSport 20 Three Bank charger must be connected to 3 individual 12V batteries, as illustrated on pages 16-22. Simply choose the illustration that has the same number of charger output bank cables as your ProSport Battery Charger in hand and wire exactly as shown (choose the illustration that matches your application) for proper charger operation.

8. Make sure all DC connections are correct, tight, and free from corrosion.
9. Locate the AC power cord in an open-air area of your boat at least 21 inches from the charger, batteries, and fuel fill lines.
10. Connect a heavy duty UL approved extension cord to the battery charger first. **After connecting the extension cord to the charger, proceed to plug the extension cord to a nearby 120/230 VAC GFCI protected (Ground Fault Circuit Interrupt) outlet.** Always remove the extension cord from the 120/230 VAC outlet first when charging is completed, followed by unplugging the charger. You are now connected and charging your batteries. View the LED indicators.

4 Steps to Wire your ProSport Charger Correctly

STEP 1: Simply choose the illustration that has the same number of charger output bank cables as your ProSport Battery Charger in hand and wire exactly as shown (choose the illustration that matches your application) for proper charger operation.

STEP 2: Do not remove your batteries series or parallel jumper cables that interconnect batteries to each other. ProSport Chargers are designed with isolated outputs and series or parallel jumper cables do not have to be removed.

STEP 3: Your ProSport charger will not operate properly if it is not connected properly to each battery. Reminder, the ProSport and each DC jacketed bank cable must be properly connected to "individual 12V batteries". Number of DC jacketed bank cables equals the number of batteries that must be individually connected. Example: a three bank ProSport 20 3 Bank must be connected to 3 individual 12V batteries. As Illustrated on Pages 16-22. Select your battery / trolling motor configuration for the specific wiring illustration needed for your charger.

INSTALLATION

15

Installation

STEP 4: Incorrect wiring will result in reverse polarity or high reverse voltage, in the event this happens, the ProSport Charger has been designed to not fail as a result, however it will cause the charger to “internally disconnect” and provide “no output” until the (reverse polarity caused by putting the “red” + lead on a - negative battery terminal) and or the (high reverse DC voltage caused by taking one bank cable and spreading it across two batteries) is corrected, using the wiring diagrams as shown on pages 16-22. In the event of a reverse polarity connection or an improper battery connection or if an output is not connected to a battery the appropriate red battery bank trouble LED will illuminate identifying the battery and wiring connections where a fault is present. See page 25 for further details.

Installation

When connecting each jacketed battery charger cable, make sure it is connected to only one **12 VDC battery** and observe the polarity and color of all connections:

Red Wire = + (Positive) Battery connection

Black Wire = - (Negative) Battery connection

The black wire can never be connected to a terminal with red wires. Only black.

Important: The pair of red and black wires in 1 cable jacket MUST GO TO THE SAME 12VDC battery.

Each charger cable must be connected to 1 battery, just as shown. Observe black to (-) and red to (+). Do this for each battery.

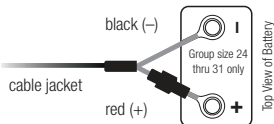

When connecting to an engine start battery only connect the battery bank cable that is LABELED: “FOR ENGINE BATTERY USE THIS BANK CABLE ONLY”.

Application Tip

If your application is for 4D or 8D large capacity batteries, please refer to ProMariner’s website www.promariner.com and view our ProNauticP Hardwired Charger Assortment for a model that is correct for this group size of batteries.

Typical Wiring

Fig. 1 ProSport 15 (OEM only) and 20 Three Bank Charger for 3 12V Batteries

Dedicated 12 VDC Trolling/House Bank and 2 Engine Crank Batteries Typical Configuration

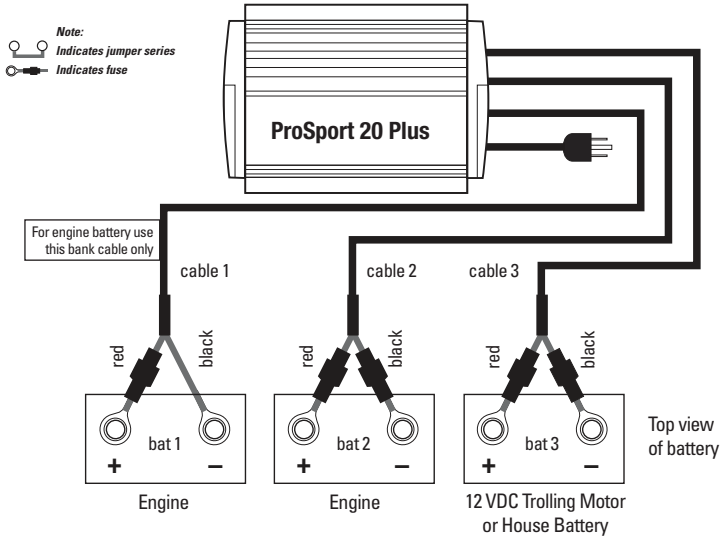

Installation

When connecting each jacketed battery charger cable, make sure it is connected to only one **12 VDC battery** and observe the polarity and color of all connections:

- Red Wire = + (Positive) Battery connection
- Black Wire = - (Negative) Battery connection
- The black wire can never be connected to a terminal with red wires. Only black.

Important: The pair of red and black wires in 1 cable jacket MUST GO TO THE SAME 12VDC battery.

Note 1: One bank cable connects to no more than one battery

Note 2: ProSport is designed to be used with group 24, 27, 30 and 31 batteries

Typical Wiring

Fig. 2 ProSport 15 (OEM only) and 20 Three Bank Charger for 3 12V Batteries

24 VDC Trolling Motor Battery Configuration with (2) 12 VDC Batteries Connected with a Series Jumper Plus Dedicated 12 VDC Engine Start Battery

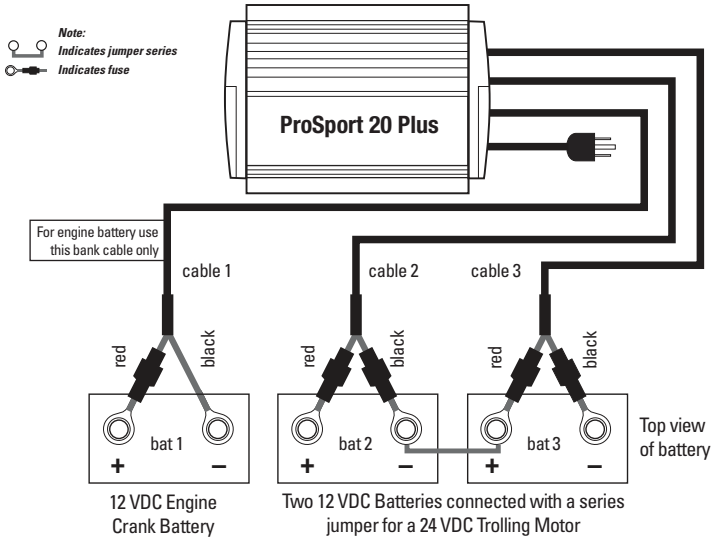

Installation

When connecting each jacketed battery charger cable, make sure it is connected to only one **12 VDC battery** and observe the polarity and color of all connections:

Red Wire = + (Positive) Battery connection

Black Wire = - (Negative) Battery connection

The black wire can never be connected to a terminal with red wires. Only black.

Important: The pair of red and black wires in 1 cable jacket MUST GO TO THE SAME 12VDC battery.

Note 1: One bank cable connects to no more than one battery

Note 2: ProSport is designed to be used with group 24, 27, 30 and 31 batteries

Typical Wiring

Fig. 3 ProSport 15 (OEM only) and 20 Three Bank Charger for 3 12V Batteries

Dedicated 36 VDC Trolling Motor Battery Configuration
with (3) 12 VDC Batteries Connected with (2) Series Jumpers

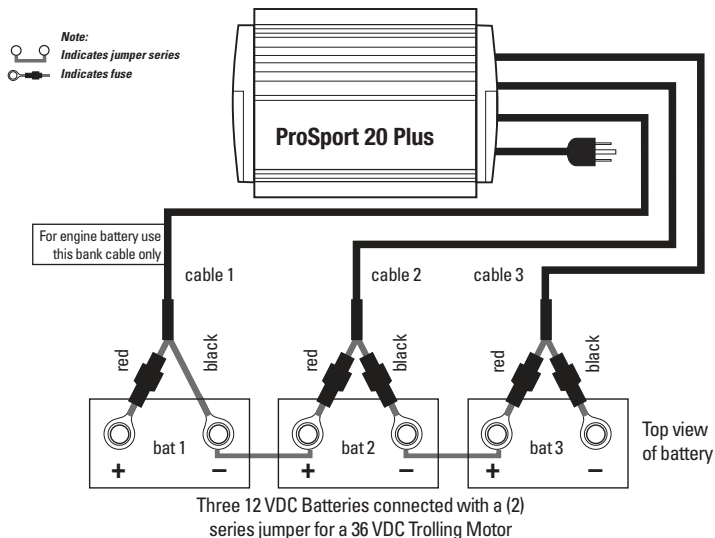

Installation

When connecting each jacketed battery charger cable, make sure it is connected to only one **12 VDC battery** and observe the polarity and color of all connections:

Red Wire = + (Positive) Battery connection

Black Wire = - (Negative) Battery connection

The black wire can never be connected to a terminal with red wires. Only black.

Important: The pair of red and black wires in 1 cable jacket MUST GO TO THE SAME 12VDC battery.

Note 1: One bank cable connects to no more than one battery

Note 2: ProSport is designed to be used with group 24, 27, 30 and 31 batteries

Typical Wiring

Fig. 4 ProSport 20, 12 and 8 Two Bank Charger for 2 12V Batteries

12 VDC Engine Start and a 12 Volt Trolling Motor or House Battery Configuration with (2) 12 VDC Batteries

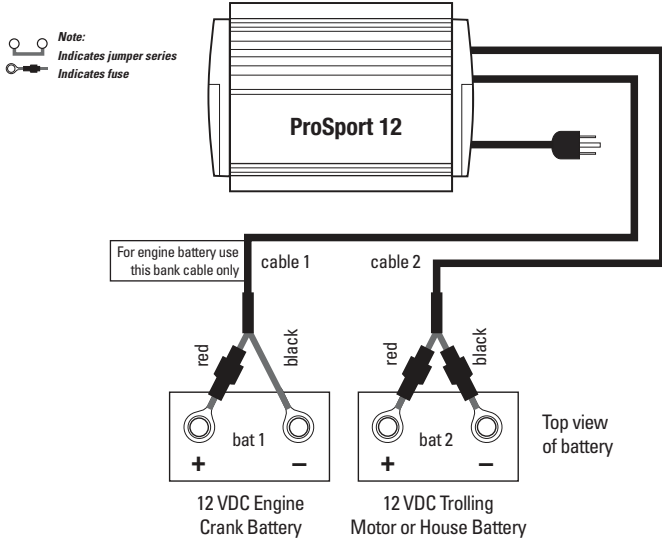

Installation

When connecting each jacketed battery charger cable, make sure it is connected to only one **12 VDC battery** and observe the polarity and color of all connections:

Red Wire = + (Positive) Battery connection

Black Wire = - (Negative) Battery connection

The black wire can never be connected to a terminal with red wires. Only black.

Important: The pair of red and black wires in 1 cable jacket MUST GO TO THE SAME 12VDC battery.

Note 1: One bank cable connects to no more than one battery

Note 2: ProSport is designed to be used with group 24, 27, 30 and 31 batteries

Typical Wiring

Fig. 5 ProSport 20, 12 and 8 Two Bank Charger for 2 12V Batteries

Dedicated 24 VDC Trolling Motor Battery Configuration
with (2) 12 VDC Batteries Connected with a Series Jumper

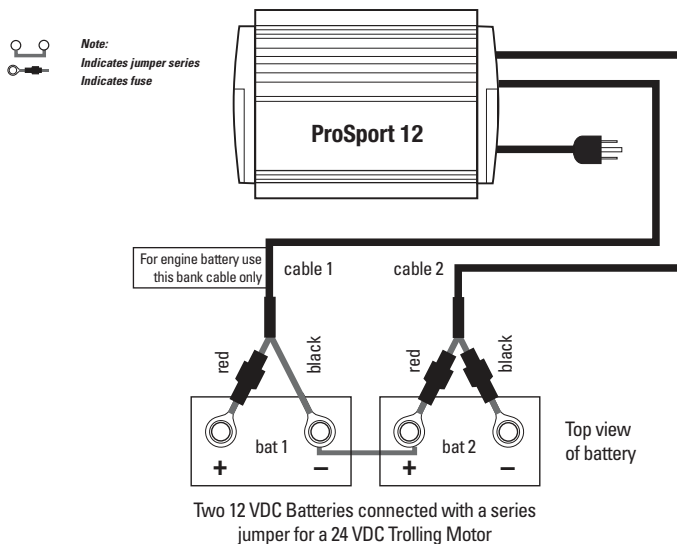

Installation

When connecting each jacketed battery charger cable, make sure it is connected to only one **12 VDC battery** and observe the polarity and color of all connections:

Red Wire = + (Positive) Battery connection

Black Wire = - (Negative) Battery connection

The black wire can never be connected to a terminal with red wires. Only black.

Important: The pair of red and black wires in 1 cable jacket MUST GO TO THE SAME 12VDC battery.

Note 1: One bank cable connects to no more than one battery

Note 2: ProSport is designed to be used with group 24, 27, 30 and 31 batteries

Typical Wiring

Fig. 6 ProSport 20, 12 and 8 Two Bank Charger for 2 12V Batteries in Parallel

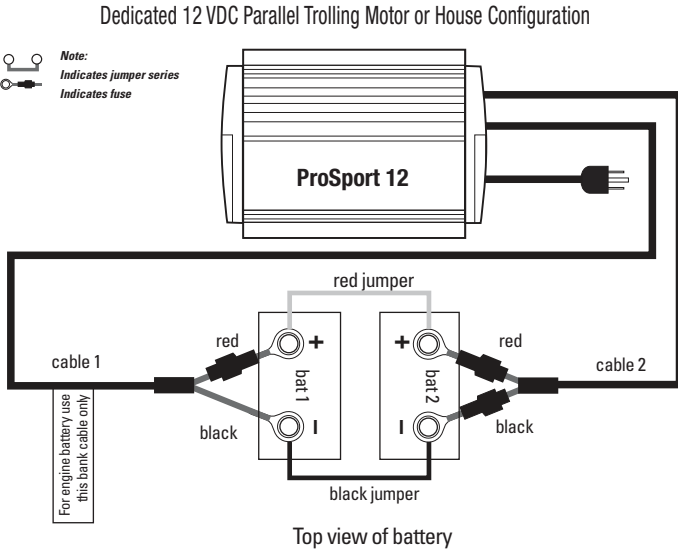

Installation

When connecting each jacketed battery charger cable, make sure it is connected to only one **12 VDC battery** and observe the polarity and color of all connections:

Red Wire = + (Positive) Battery connection

Black Wire = - (Negative) Battery connection

The black wire can never be connected to a terminal with red wires. Only black.

Important: The pair of red and black wires in 1 cable jacket **MUST GO TO THE SAME 12VDC battery.**

Note 1: One bank cable connects to no more than one battery

Note 2: ProSport is designed to be used with group 24, 27, 30 and 31 batteries

Typical Wiring

Fig. 7 ProSport 6 One Bank Charger for 1 12V Battery

Dedicated 12 VDC Trolling Motor, House or Engine Battery Configuration

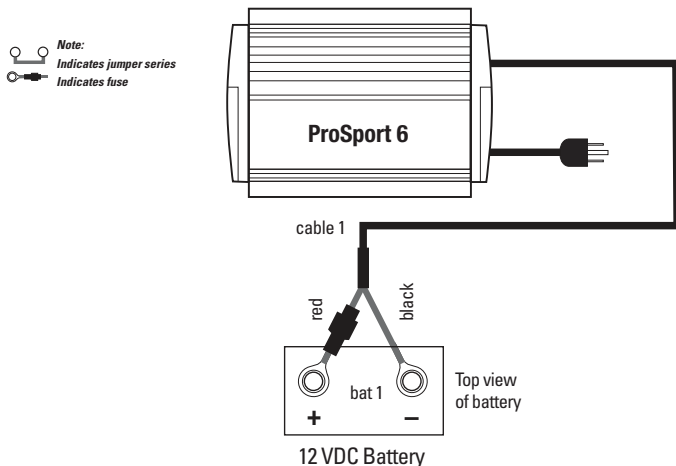

Installation

When connecting each jacketed battery charger cable, make sure it is connected to only one **12 VDC battery** and observe the polarity and color of all connections:

Red Wire = + (Positive) Battery connection

Black Wire = - (Negative) Battery connection

The black wire can never be connected to a terminal with red wires. Only black.

Important: The pair of red and black wires in 1 cable jacket MUST GO TO THE SAME 12VDC battery.

Note 1: One bank cable connects to no more than one battery

Note 2: ProSport is designed to be used with group 24, 27, 30 and 31 batteries

Charging your Batteries

The ProSport Charger is designed to charge, condition, maintain and recondition your batteries. Please follow these steps each time you use your ProSport charger:

1. Open all battery compartments and ventilate for at least 15 minutes before applying AC power to your charger. While charging your batteries make sure to keep your battery compartment open allowing for free air ventilation.
2. Make sure all DC battery connections are tight and clean. Follow battery manufacturer's recommendations for battery cell caps. (loosen caps if applicable).

Once your new ProSport is installed and properly connected to batteries you will be ready to plug it in.

3. Connect a heavy duty UL approved extension cord to the ProSport charger first. **After connecting the extension cord to the charger, proceed to plug the extension cord to a nearby 120/230 VAC GFCI protected (Ground Fault Circuit Interrupt) outlet.**
4. Assuming your batteries are discharged, and your ProSport is factory set (black programming cap installed) for standard Flooded (lead-acid) batteries, you should observe ProSport's self test mode (flashing red charge mode LED), blue AC power LED turn on, followed by the red battery type LED turning on (red is the factory setting of standard Flooded (lead-acid)/AGM type batteries) and once the green system check OK LED turns on you will notice a solid red charge mode indicator identifying the charging process has started.

Note: The ProSport has built in self testing to insure all batteries are connected correctly. The self test is automatic and will take place everytime the unit is plugged into a 120 230 VAC outlet. The self test may take 2 minutes to complete. During the self test the LED will flash indicating it is in self test mode. If everything is connected properly and the batteries are OK the charger's system check OK indicator will illuminate green and the ProSport will then go into its charge mode indicated by a solid red LED.

If the charger does not go into the charge mode and a red "fault" LED is illuminated then make sure your batteries have a voltage greater than 2 volts DC present and refer to the trouble shooting section on page 25.

5. The multi-stage charging process is complete when only the green LED for the Auto Maintain mode is illuminated and the blue AC power LED remain on indicating that your batteries are fully charged and are being automatically maintained with (Energy Saver Mode) which will monitor batteries and Auto Maintain batteries only when needed to maintain a full state of charge.
6. When you are ready to use your boat, unplug your extension cord at the GFCI outlet first, followed by unplugging the charger.

Optional Battery Bank Status Monitor

See your local dealer or retailer for the ProMariner Remote Battery Bank Status Monitor. The remote monitor is easy to install and connects directly to your boat's batteries. Once installed, simply hold down the "push-to-test" button and observe the charge level indicator for each battery (up to 3 batteries can be monitored).

Note: AC power to the battery charger and the boat's engine must be off when using the Remote Battery Bank Status Monitor.

Maintenance

Item: Battery Connections	
Process:	Clean and tighten all battery connections. Follow battery manufacturer's instructions for cleaning a battery. Clean all battery terminals with a wire brush where required and tighten all battery connections.
When:	Monthly

Item: Battery Electrolyte	
Process:	Per battery manufacturer's instructions, monitor, and maintain proper levels of distilled water in each battery.
When:	Monthly

Item: ProSport DC Output Wiring	
Process:	Visually inspect all wiring for cuts and abrasions. Contact ProMariner if your charger needs to be serviced.
When:	Monthly

Item: AC Power Cord and Mounting Hardware Inspection	
Process:	Visually inspect the AC power cord. Confirm ground blade is present and all plug blades are in good condition and not bent out of place. Check all mounting hardware to ensure there is no loose hardware. Tighten where required.
When:	Monthly

Troubleshooting

No Blue AC Power LED or Charge Mode Indicator or Battery Type LED

Check for loss of AC power at the 120/230 VAC outlet. Confirm GFCI (Ground Fault Circuit Interrupter) has not tripped. Check with a meter or 120/230 VAC test light that AC power is present at the end of your extension cord. Reset AC power if it was not present. Confirm all charger cables are installed with the correct polarity connections at each battery and that all connections are clean and tight. Wait 2 minutes while unit performs self test. If AC power is present and all connections are correct and LEDs do not illuminate, contact ProMariner at +1-800-824-0524 from 8:30 am to 5pm Eastern Time. If your ProSport is within the warranty period of 2 years from the date of purchase, you can go to www.promariner.com where you will find our customer care return form and instructions.

Green System Check OK Indicator is OFF & a Red Battery Bank Trouble Status LED is ON.

Identify the battery bank LED that is lit, remove AC power and check the battery bank indicated i.e 1, 2, 3 (model specific). The LED indicates there is a fault present. Listed below are typical faults and what can be done to clear the red battery bank trouble status indicator (reapply AC power after making any corrections):

Poor battery connections - Make sure all connections are tight and clean

Blown DC cable fuse - Make sure all fuses are good with a digital ohm meter

or continuity tester and visually inspect the ProSport's DC battery cables to insure they have not been compromised or shorted in any way.

Reverse polarity - Make sure all wiring connections are color coded and connected properly and that each bank cable goes to one 12V battery where (+) = red (-) = black.

Battery too low to charge - with a digital voltmeter make sure the battery is over 2.0 volts DC (if not have your battery charged out of the boat and have it load tested by your local battery dealer to insure optimum performance on the water.

High battery voltage input - Check to make sure one bank lead was not spread across 2 batteries connected in series for 24 volts DC. If so correct by wiring to the diagrams on pages 16- 22.

Battery(s) not charging, Blue AC Power LED, RED Charging & Battery Type LEDs are ON

Confirm all charger cables are installed with the correct polarity connections at each battery, and that all connections are clean and tight. Confirm that there are no bank trouble status LED indicators on. With the charger on, read DC voltage at each battery. If any of the readings are less than 13 volts DC proceed with the following:

- A. Disconnect AC power at the 120/230 VAC outlet.
- B. Go to pages 16-22 of this manual and confirm your ProSport model charger is connected correctly as illustrated in the installation drawings.
- C. Upon completing B above; plug your charger into AC power and observe the LED center. Charger should be in the charging mode (charge status indicator should be red). After completing a full charge cycle, 10-12 hours or more for deeply discharged or completely dead batteries, the charge mode LED indicator should be green and the AC power LED should be blue.

Note: If a Digital Volt Meter (DVM) is available to you, instead of waiting to complete a full charge cycle, you can simply use a DVM and take DC voltage measurements across each 12 volt battery. As long as the voltage continues to increase while the red charging LED is on, this will serve as a confirmation that the charger is properly connected and is properly charging.

Specifications

model	part no.	volts	amps	banks	cables	size L x W x H	weight	AC in
ProSport 6 PFC	43023	12	6	1	6'	7.125" x 7.25" x 2.75"	2 lbs	100-260
ProSport 12 PFC	43026	12/24	12	2	6'	9.875" x 7.25" x 2.75"	4 lbs	100-260
ProSport 20 PFC	43028	12/24	20	2	6'	12.125" x 7.25" x 2.75"	5 lbs	100-260
ProSport 20Plus PFC	43029	12/24/36	20	3	6'	12.125" x 7.25" x 2.75"	6 lbs	100-260

Accessories

ProSport 1.5 Battery Maintainers

Fully automatic, with built-in safety.
LED status indicator, 1-year warranty



ProMariner & Universal Plug Holders

Secure your AC plug with an easy to mount plug holder. No cutting or stripping of wires required. Safe and easy to use. Choose from two colors, black or white.



Remote Battery Bank Status Monitor

Remote "Push to Test" status indicators for up to 3 batteries with easy to read LED indicators. Universal flush or surface mount capable.



Battery Bank Cable Extenders

No cutting, stripping, or splicing wires! 2 convenient sizes to choose from: 5' or 15'. Gold plated terminals, in line fuses and hardware included.



Hand Held Digital Multi-Meter

Test and measure AC and DC voltage and amperage, continuity, resistance fuses outlets and more. Large digital LCD display with back light and hold feature. Test leads included.



Model

Handheld DC System Tester
Remote Battery Bank Status Monitor for up to 3 Batteries
ProMariner's AC Plug Holder (white)
ProMariner's AC Plug Holder (black)
Universal AC Plug Holder (black)
Universal AC Plug Holder (white)
15' Battery Bank Cable Extender
5' Battery Bank Cable Extender
Hand Held Digital Multi-Meter

Part No.

87710
51060
51200
51201
51202
51203
51070
51071
87730

To place an order contact your local retailer, dealer or ProMariner at:
603-433-4440 / Fax: 603-433-4442 / www.promariner.com

Environment and disposal



Correct disposal of this product

(Waste Electrical & Electronic Equipment)

This product is designed and manufactured with high quality materials and components, which can be recycled and reused. When this crossed-out wheeled bin symbol is attached to a product, it means the product is covered by the European Directive 2012/19/EU.

Please be informed about the local separate collection system for electrical and electronic products.

Please act according to your local rules and do not dispose of your old products with your normal household waste. The correct disposal of your old product will help prevent potential negative consequences to the environment and human health.

ProSport Warranty

We are committed to customer satisfaction and value your business. If at any time during the warranty period you experience a problem with your new ProSport On-Board Marine Battery Charger, simply call us at +1-800-824-0524 for technical support or email info@promariner.com.

WARRANTY CARD CAN BE REGISTERED AT WWW.PROMARINER.COM

or the warranty card included in this manual can be completed and sent to ProMariner by mail.

PROSPORT LIMITED TWO-YEAR FACTORY WARRANTY

Each ProSport model is guaranteed against defects in material and workmanship to the original consumer in normal use for 2 years from the date of purchase. Professional Mariner, LLC will at its discretion repair or replace free of charge any defects in material or workmanship.

The following conditions apply:

- Warranty and repair adjustment calculated from manufacture date if not registered or proof of purchase within two weeks of sale.
- Warranty void if unauthorized repairs attempted.
- Deep water damage not covered under warranty
- Customer is responsible for shipping to ProMariner.
- Cosmetic repairs are done at the owner's request and expense.

Purchase or other acceptance of the product shall be on the condition and agreement that Professional Mariner, LLC SHALL NOT BE LIABLE FOR INCIDENTAL OR CONSEQUENTIAL DAMAGES OF ANY KIND. (Some states do not allow the exclusion or limitation of incidental or consequential damages, so the above limitations may not apply to you.) This warranty is made in lieu of all other obligations or liabilities on the part of Professional Mariner. Professional Mariner neither assumes nor authorizes any person for any obligation or liability in connection with the sale of this product.

To make a claim under warranty, go to www.promariner.com and click on the support tab and follow the instructions making sure to identify the product and the problem. If you can not use our online warranty claim registration, please feel free to call ProMariner at the toll free number listed below. Professional Mariner will make its best effort to repair or replace the product, if found defective within the terms of the warranty, within 30 days after return of the product to the company. Professional Mariner will ship the repaired or replaced product back to the purchaser. This warranty gives you specific legal rights, and you may also have other rights, which vary from state to state or province to province. This warranty is in lieu of all others expressed or implied.

Factory Service Center & Technical Support
Professional Mariner, LLC
200 International Drive, STE 195
Portsmouth, NH 03801.
Tel: +1-800-824-0524

Professional Mariner, LLC
Tel: (603) 433-4440 / Fax: (603) 433-4442

ProMariner™

Visit ProMariner online at www.promariner.com, for a complete selection of quality marine products...

Here are just a few:

- ProMar1 Series - Recreational Grade Waterproof Marine Battery Chargers
- ProSport Series - Heavy Duty Recreational Grade Marine Battery Chargers
- ProTournament Series - Professional Grade Tournament Grade Marine Battery Chargers
- ProNauticP Series - Sailing and Cruising Marine Battery Chargers
- ProIsoCharge Series - Digitally Controlled Zero Loss Charging Isolators
- Digital Mobile Charge In-Transit Chargers
- Battery Maintainers AC Plug Holders Battery Isolators
- Galvanic Isolators and Monitored Systems
- Corrosion Control Products
- Waterproof Marine Binoculars
- A Complete Line of Hand Held Test Meters
- Online Technical Support and Service Support

Visit frequently, we are always adding new products for your boating enjoyment!

Professional Mariner, LLC

200 International Drive, STE 195
Portsmouth, New Hampshire 03801
TEL: 603-433-4440
FAX: 603-433-4442
www.promariner.com

Made in China

Specifications subject to change without notice

Certifications:

Conforms to UL STD. 1236
Certified to CSA STD. C22.2 No. 107.2
FCC Class A

Design and Constructed to ABYC A-31



10000010952/00