



Stainless Steel
Water Dispenser

Distributeur d'eau
en acier inoxydable

Dosificador de agua
de acero inoxidable

Use & Care Guide
Guide d'utilisation et d'entretien
Manual d uso y cuidado

CAUTION: Before using water dispenser, read this manual and follow all safety rules and operating instructions.

MISE EN GARDE: Avant d'employer votre distributeur d'eau, lisez ce manuel et suivez toutes les règles de sécurité et les consignes d'utilisation.

PRECAUCIÓN: Antes de usar el dosificador de agua, lea este manual y siga todas las reglas de seguridad e instrucciones de funcionamiento.



VWD6956BLS





Thank you for purchasing a vitapur® Water Dispenser. Please read the enclosed operating instructions carefully and retain this booklet for future reference.

We have carefully engineered your vitapur® Water Dispenser to give you years of enjoyment and trouble free operation.

IMPORTANT SAFEGUARDS

- **Never turn the dispenser upside down or tilt more than 45 degrees. If the unit has been resting on its' side for an extended period of time, place the water dispenser in the upright position for approximately 12 hours before turning it on.**
- For use with 3 or 5 gallon (12 or 19 liter) water bottles and most water filtration systems (not included).
- Never use this dispenser with water that is unsafe to drink or is from an unknown source.
- Never use any other liquid in the dispenser other than known and microbiologically safe bottled water.
- Never allow children to dispense hot water without proper and direct supervision.
- This water dispenser is equipped with a grounded power cord plug for your safety. It must be plugged into a grounded outlet. Do not use an extension cord with your water dispenser.
- Keep your water dispenser in a dry place away from direct sunlight.
- Never put anything flammable close to the dispenser.
- Leave a minimum of 2" (5 cm) around the back and sides of the dispenser for proper ventilation.
- Always install your water dispenser on a level floor. Wait 3 minutes before restarting the machine after shutting it down.
- Always unplug the water dispenser before servicing or cleaning it.
- Regular cleaning of your water dispenser is required for your warranty. Please follow the cleaning instructions outlined in this manual and clean the dispenser every 4 months.

To avoid water overflow when cleaning your dispenser, always remove the bottle support collar before pouring water or cleaning solution into the reservoir.

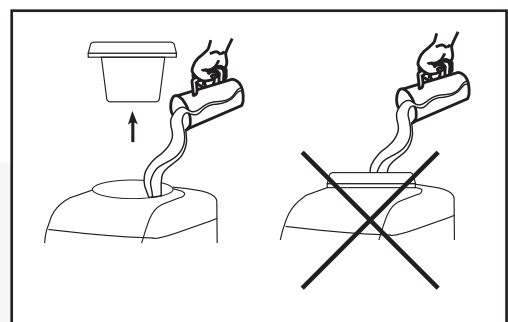

YOUR VITAPUR® WATER DISPENSER

1. Bottle support collar
2. Ready-To-Dispense indicator lights:
 - Red:** "flashing" Heater is in operation
"on" The hot water has reached its optimum temperature and is ready for dispensing
 - Blue:** "on" The cold water has reached its optimum temperature and is ready for dispensing
 - Yellow:** "on" The cleaning reminder is telling you it is time to clean your dispenser
3. Analog clock
4. Childproof safety switch
5. Hot water dispensing button (also dispenses room temperature water when Insta-HOT Feature is not activated)
6. Cold water dispensing button
7. LED night light
8. Insta-HOT activation button
9. Removable drip tray
10. Adjustable COLD water thermostat (rear of dispenser)
11. Drain valve (rear of dispenser)
12. Condenser coils (rear of dispenser)
13. Power switch (rear of dispenser)

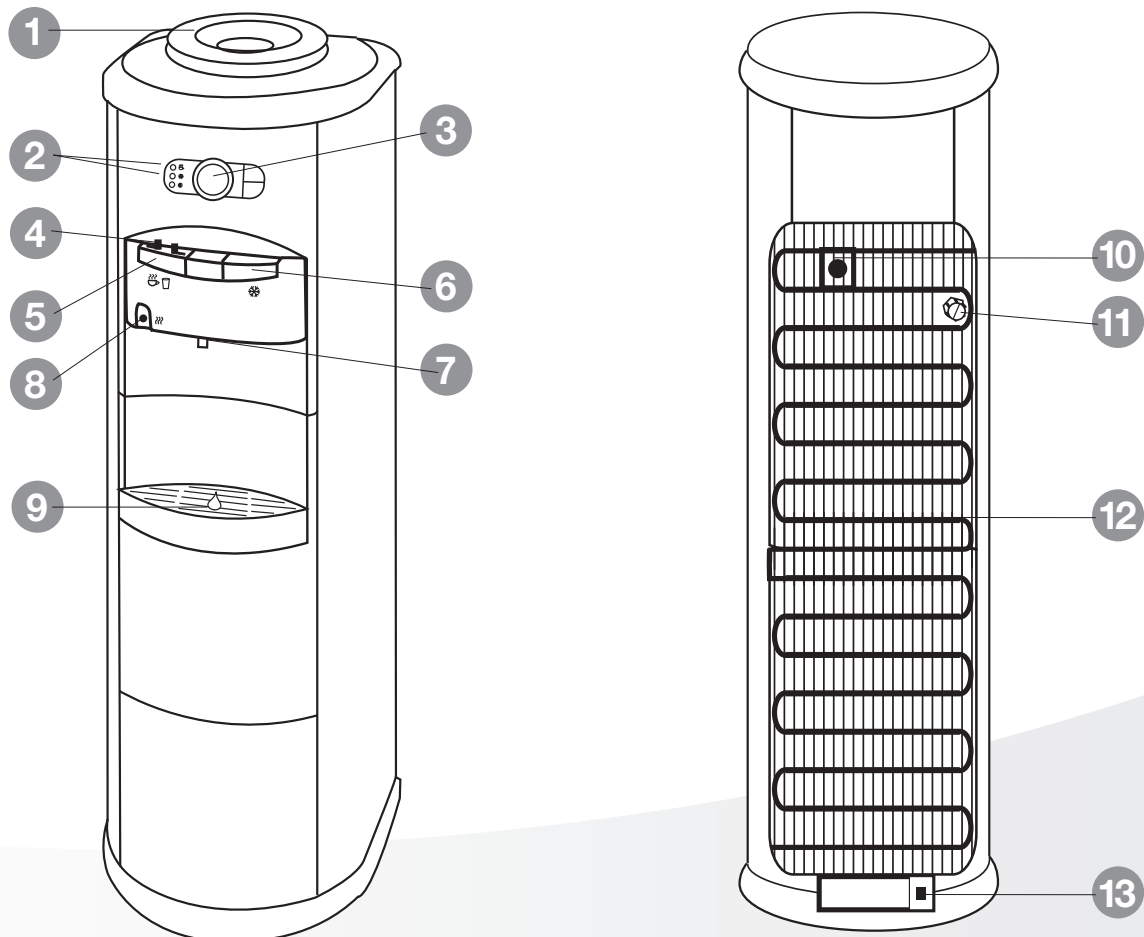

OPERATING INSTRUCTIONS

Initial Product Cleaning Procedure

As with most new appliances, there is often a plastic taste upon initial start-up of the unit. It is recommended to clean the reservoir prior to first time use.

1. Make sure the unit is unplugged and the power switch is turned off.
2. **Remove the bottle support collar**, saturate a clean cloth with a water dispenser cleaner or vinegar and wipe the inside of the reservoir.
3. Pour the water dispenser cleaner or a mixture of 0.3 gal / 1 L of vinegar with 0.3 gal / 1 L of hot water into the reservoir and wait 20 minutes.

IMPORTANT: To avoid water overflow while cleaning the dispenser, always remove the bottle support collar before pouring water or the cleaning solution into the reservoir. **(See Figure A).**

4. Press all dispensing buttons until water no longer comes out.
5. Drain the reservoirs from the drain valve on the back of the unit.
6. Rinse again with clean water.
7. Place bottle support collar back on top of dispenser.

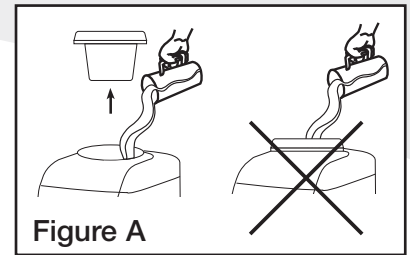

Cleaning Kit



Available online at
www.greenwayhp.com

Maintaining Your Water Dispenser

Like most appliances, your new water dispenser requires regular cleaning to operate efficiently. **Your water dispenser must be cleaned every 4 months (see procedure on page 5).**

Installing the Water Bottle

The water bottle can be purchased from your local retailer.

IMPORTANT: Always wash your hands first! Clean the top (neck) of the bottle with a clean cloth and do not touch the part of the unit that the water touches. Make sure the unit is unplugged and the power switch is in the OFF position.

1. Remove the protective cap from the end of the water bottle unless the bottle has a puncturable cap or sticker.
2. Lift and turn the bottle upside down, placing it securely on the bottle support collar.
3. Press and hold all dispenser buttons until water flows from the dispenser. Drain about 0.3 gal / 1 L of water before initial use. This does not need to be repeated with replacement bottles.
4. Plug in the water dispenser.
5. Set the power switch at the rear of the dispenser to the ON position **(see item 13 on page 2)**.
6. Ready-to-dispense indicator lights will come on when water reaches optimum temperatures and is ready for use. In order to get steaming hot water, the Insta-HOT feature needs to be activated. **(See Dispensing Hot Water, pg. 5).**

Setting the Analog Clock

To set the clock to the correct time, simply press the **HR** button to adjust the hour hand, then press the **MIN** button to adjust the minute hand.

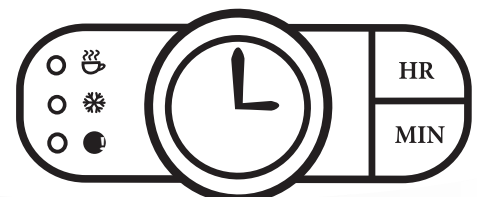

IMPORTANT NOTICE ABOUT LEAKING BOTTLES

If you find that your dispenser is leaking, check the water bottle first!

Almost all 3 and 5 gallon water bottles are recycled and handled extensively during cleaning, filling, and shipping. As a result they are very prone to developing pin holes or small cracks that can cause an overflow (or leak) when placed on top of a water dispenser.

In almost all cases, there is nothing wrong with your water dispenser. If you are experiencing a leak, this simple test will allow you to determine whether your water bottle or dispenser is the source of the problem.

1. Unplug the unit, turn off the power switch and remove the water bottle.
2. a) Remove the bottle support collar and check the water level inside the reservoir – it should be at roughly three-quarters full.
b) Please add or drain a few glasses of water to achieve the required fill level. Water level should be approximately 3/4" – 1" **BELOW VENT TUBE**.
3. Let the water sit for approximately 2 hours. If the dispenser does not leak, it is the bottle that is leaking due to a small crack or pinhole. Please contact your water supplier for a replacement bottle.

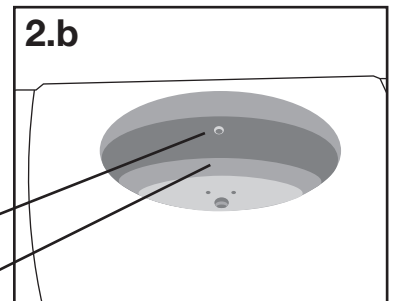
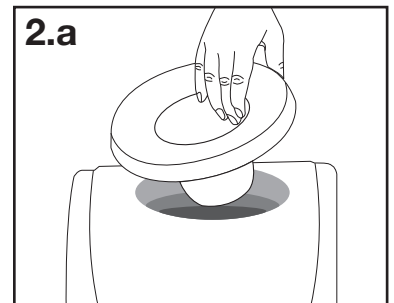
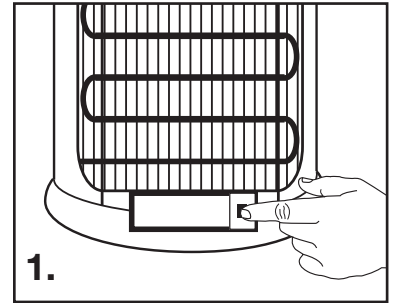

Please visit us at www.greenwayhp.com for water dispenser accessories and helpful use and care tips.

Dispensing Room and Cold Water

Place a glass under the spigot. For cold water, press the ❄️ button until the desired amount of water is dispensed. To dispense room temperature water, press the 🍵 button downward until the desired amount of water is dispensed. **IMPORTANT:** Do not press the Insta-HOT feature for room temperature water. It will activate the hot water tank and dispense steaming hot water after approximately 3 minutes. For hot water, **see Dispensing Hot Water (pg. 5).**

Adjusting the Temperature (Cold water only)

By turning the thermostat at the back of the unit, the temperature can be adjusted. Turn the dial clockwise between the min (cool) and max (colder) levels until the desired temperature is reached.

If the water dispenser is not dispensing water, there could be a possible ice build up due to the thermostat being set too cold. If this happens, unplug the dispenser overnight and then reset. Set thermostat to MIN, slowly increasing based on your use and need for cold water.

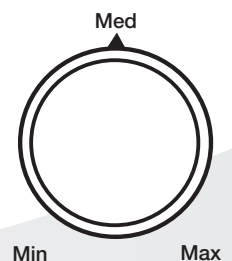

Dispensing Hot Water

This water dispenser has a power saving Insta-HOT button which activates the water heater only when pressed, so you get hot water on demand without the cost of constantly heating water!

To dispense hot water, first press the Insta-HOT activation button. The red indicator light will begin flashing to indicate that the water heater is on and active. In approximately 3 minutes the set temperature point will be reached and the red light will stop flashing and remain on. The water is now ready to be dispensed. Squeeze the 2 safety switches and press down on the  button until the desired amount of water is dispensed. If water is not immediately dispensed, the water will begin to cool and the red light will shut off, requiring you to initiate another cycle.

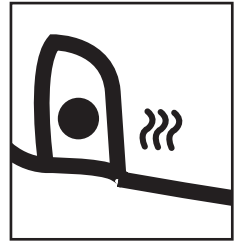

Childproof Safety Feature

To prevent hot water from accidentally harming a child, the hot water dispenser button has 2 safety switches on it. Squeeze the safety switches towards the center of the button and push downward to dispense.

DANGER: The hot water is heated to approximately 194° F / 90° C. Temperatures above 125° F / 52° C can cause severe burns from scalding.

DO NOT ALLOW CHILDREN TO USE THE HOT WATER DISPENSING BUTTON WITHOUT PROPER AND DIRECT SUPERVISION.

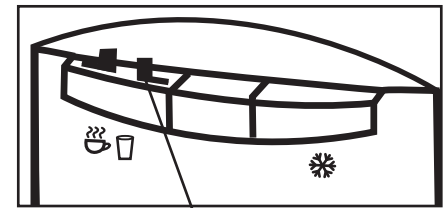

Childproof safety switch

CLEANING AND MAINTENANCE

Electronic Cleaning Reminder

Like most appliances, your new water dispenser requires periodic maintenance to operate efficiently. Your water dispenser must be cleaned every 4 months. For your convenience, your water dispenser is equipped with a cleaning reminder that will activate following 4 months of use. The yellow light beside the  symbol will illuminate, telling you it is time to clean your dispenser.

Once the unit has been cleaned following the cleaning instructions outlined below, the cleaning reminder needs to be reset. Reset the reminder by pressing and holding both the **HR** and **MIN** buttons at the same time for 3 seconds. This will reset the cleaning reminder, and it will activate following the next 4 months of use.

If the unit remains in operation for another month (total of five months operation) and the water dispenser has not been cleaned and reset, the cleaning reminder indicator (yellow LED) will begin to flash as a reminder that cleaning is required. Please note that per your warranty, routine maintenance of the dispenser is required. Failure to maintain the water dispenser will void your warranty.

Cleaning Your Water Dispenser

IMPORTANT: Make sure you turn the power switch to the OFF position and unplug the dispenser before performing any of the following cleaning procedures.

Cleaning the Outside of the Water Dispenser

The outside of the dispenser can be wiped clean with a water dispenser cleaning solution or a mild soap and water mixture. Never use harsh chemicals or abrasive cleaners. Rinse thoroughly with clean water and then dry the surfaces.

Cleaning the Drip Tray

To remove, take the grill off the drip tray and firmly lift the tray up, dislodging it from the dispenser. Drain and clean.

The drip tray should be emptied and cleaned regularly to remove spotting and any mineral deposits. Clean with a water dispenser cleaning solution or a mild soap and water mixture. For tough deposits, add vinegar and let it soak until the deposits come loose. Then wash, rinse and dry thoroughly.

To replace, put the grill back on the tray and slide the tray onto the guides.

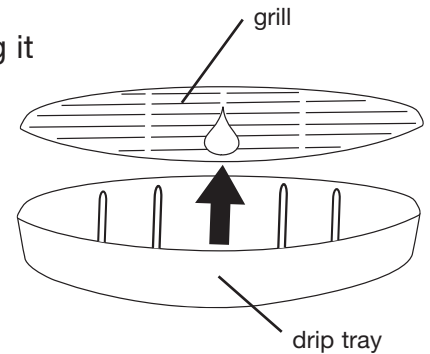

Cleaning the Condenser

Vacuum or sweep away the dust from the condenser coils at the back of the dispenser. For best results, you can purchase a brush designed specifically for this purpose from your local appliance store. This will improve cooling and efficiency of your unit.

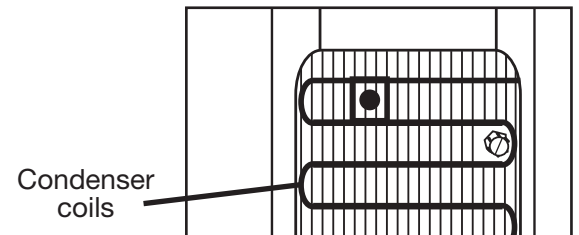

Draining the Reservoirs

Drain the reservoir

- Before and after cleaning your unit.
- When going on long vacations.
- If you are not using the dispenser for long periods of time.

IMPORTANT! Turn the power switch to the OFF position and unplug the dispenser before performing this procedure. Dispense hot water until temperature drops to a safe level to avoid the risk of scalding.

1. Remove the water bottle.
2. Press all dispensing buttons until water no longer comes out.
3. Place a bucket beneath the drain outlet on the back of the dispenser.
4. Remove the cap and plug from the drain valve and let the water flow into the bucket. Replace the cap and plug. A screwdriver or coin can be used to help loosen the drain cap.
IMPORTANT: Collect the water in a container, not the drip tray.
5. Replace the water bottle. (**See *Installing the Water Bottle*, pg. 3.**)

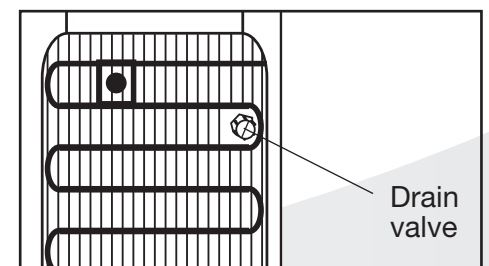

Cleaning the Inside of the Dispenser

To prevent mineral deposits that can affect the taste and flow of the water and to ensure proper product performance, your water dispenser must be cleaned every 4 months.

1. Make sure the power switch is in the OFF position.
2. Remove the water bottle and **bottle support collar**.
3. Drain the reservoirs. **(See *Draining the Reservoirs*, pg. 6).**
4. Pour the water dispenser cleaner or a mixture of 0.3 gal / 1 L of vinegar with 0.3 gal / 1 L of hot water into the reservoir and wait 20 minutes. If using a water dispenser cleaning solution, please follow the manufacturer's instructions.

IMPORTANT: To avoid water overflow while cleaning the dispenser, always remove the bottle support collar before pouring water or cleaning solution into the reservoir. **(See *Figure A*, page 3).**

5. Press all dispensing buttons until water no longer comes out.
6. Drain the reservoirs.

IMPORTANT: Collect the water into a container, not the drip tray.

7. Rinse with clean water.
8. Replace the bottle support collar and the water bottle. **(See *Installing the Water Bottle*, pg. 3).**

IMPORTANT: Drain approximately 4 glasses of water from each button before initial use.

This does not need to be done with replacement bottles.



Going Away on Vacation

When not using the dispenser for long periods of time or when going on vacation, conserve energy by setting the power switch to the OFF position, unplug the dispenser and drain the reservoirs.

(See *Draining the Reservoirs*, pg. 6). Follow ***Initial Product Cleaning Procedures* (pg. 3)** upon return and startup of the dispenser.

SPECIFICATIONS



VWD6956BLS

Output per hr:	Hot	1.2 gal / 4.6 L
	Cold	0.5 gal / 2.0 L
Internal Tank:	Hot	0.2 gal / 0.6 L
	Cold	0.8 gal / 3.2 L
Heating Temp (approx.):		194°F / 90°C
Cooling Temp (approx.):		46°F / 8°C
Power Consumption:	Hot	1100 W
	Cold	90 W

WARNING: The Water Dispenser heats and dispenses water to 194°F / 90°C which can cause severe burns or scalding.

DO NOT ALLOW CHILDREN TO USE THE HOT WATER DISPENSING BUTTON WITHOUT PROPER AND DIRECT SUPERVISION.



Childproof safety switch

TROUBLESHOOTING TIPS

Problem	Possible Cause	Suggested Solution
Water dispenser or dispensing tap is leaking	Small pin hole or crack in the bottle, (common with recycled water bottles)	Conduct water bottle leak test outlined on page 4.
	Drain cap and silicone seal are not secure.	Ensure seal is secure in drain plug and tighten drain cap.
	Water was poured directly into bottle support collar and overflowed.	Drain by pressing all dispenser buttons.
	Possible air pocket.	Press dispenser buttons several times to relieve air pocket and release to re-set valve.
Water is not hot or cold enough	All the water in the tank has been used.	Replace with full water bottle and wait 30 minutes for the water to heat or cool.
	The unit is unplugged.	Plug it into the outlet.
	Insta-HOT was not activated.	Activate Insta-HOT by pressing the button.
	The circuit breaker in your home is tripped or the fuse has blown.	Reset the breaker or replace the fuse in your home.
	Power switch not turned on at back of unit.	Turn the switch to the ON position.
	Temperature limit tripped.	Set power switch to the OFF position, wait 5 minutes, then set power switch to the ON position. Wait 30 minutes for the water to heat or cool.
	Thermostat needs to be adjusted colder.	Adjust thermostat between min (cool) and max (colder) levels to achieve desired temperature.
Water dispenser is not dispensing water	Empty water bottle.	Replace with full bottle.
	Mineral deposits clogging tanks.	See <i>Cleaning the Inside of the Dispenser.</i> (pg. 7)
	Possible air pocket.	Push down on the dispenser buttons to prime the unit.
	Possible ice build up due to thermostat set too cold.	Unplug overnight, then reset. Set thermostat to MIN, slowly increasing based on your use and need for cold water.
Water dispenser is noisy	Bottle making a gurgling noise as it fills the tank.	This is normal.
	Water dispenser is uneven.	Make sure the dispenser is on an even surface that can support its full weight.

ATTENTION: Do not return this product to the store. For questions on operation, assembly or parts, please contact us at www.greenwayhp.com or **1-866-253-0447**.

FREQUENTLY ASKED QUESTIONS

Q: Why is my water dispenser leaking?

A: If you are experiencing a leak with your water dispenser please do the following to see if the water bottle or the dispenser is leaking.

1. Unplug the unit, turn off the power switch and remove the bottle.
2. Remove the bottle support collar and check the water level inside the reservoir – it should be at roughly three-quarters full. Water level should be approximately 3/4” – 1” **BELOW VENT TUBE**.
3. Let water sit for 2 hours. If the dispenser does not leak, it is the bottle that is leaking due to a small crack or pinhole and it needs to be replaced. If the dispenser is leaking, please contact Greenway Home Products at support@greenwayhp.com or **1-866-253-0447**.

Q: Why do I get a plastic taste from my dispenser?

A: As with most new appliances such as coffee makers and kettles, there is often a plastic taste upon initial start-up of the unit. To remove this taste, simply follow the cleaning instructions outlined in *Cleaning the Inside of the Dispenser. (pg. 3 or 7)*

Q: What do the ready-to-dispense indicator lights mean?

A: When illuminated, they mean the following:

Red:	“flashing” "on"	Heater is in operation The hot water has reached its optimum temperature and is ready for dispensing
Blue:	"on"	The cold water has reached its optimum temperature and is ready for dispensing
Yellow:	"on"	The cleaning reminder is telling you it is time to clean your dispenser

Q: What is the spike that goes into the bottle?

A: vitapur® water dispensers feature a “piercing valve” as part of the bottle support collar, providing added convenience for water bottle installation. Depending on the water bottle supplier, a small opening may or may not be present in the bottle cap for this specific purpose. If the piercing valve opening is not present, the entire bottle cap must then be removed to eliminate possible damage to the piercing valve. If the opening is present, remove the protective seal prior to installing the bottle.