

FUJIFILM

instax mini Evo™

HYBRID INSTANT CAMERA

[INSTANT PRINT + DIGITAL TECHNOLOGIES]

User's Guide (Full version)



- This User's Guide (Full version) corresponds to firmware version Ver.1.01. Depending on the firmware version, the functions and screens may differ from those described.
- There are two methods to upgrade the firmware. For details, refer to [FIRMWARE UPGRADE]. (p. 22)

Table of Contents

Before Using the Camera	3	Miscellaneous Actions	17
Notes on Disposing of the Camera	3	Changing the Brightness of the Image.....	17
About This Camera	3	Using the Self-Timer to Take Photos.....	17
Main Features	3	Taking Photos with the Flash.....	18
Free, Downloadable INSTAX MINI EVO App.....	3	Taking Macro Photos.....	18
Part Names.....	4	Matching the Light Source when Taking Photos	19
LCD Screen	6	Taking a Photo of Yourself (Selfie)	19
Using the Select Buttons.....	7	Using AF/AE Lock to Take Photos	20
Attaching the Shoulder Strap	7	Printing from Print History	20
Charging the Battery	8	Using the Memory Card	21
Charging Status Indication	8	Inserting a Memory Card.....	21
Power On/Off.....	8	Using the Shooting Menu	22
How to Check the Battery Level.....	9	Using the Playback Menu	23
Configure the Initial Settings	9	Smartphone App Functions	24
Loading/Unloading the INSTAX MINI™ Instant Film Pack... 11		Direct Print Function	24
Loading the INSTAX MINI instant film pack	11	Remote Shooting Function.....	24
Unloading a Used INSTAX MINI instant film pack.....	12	Printed Image Transfer Function	24
Basic Shooting and Playback	12	Specifications	24
Taking Photos	12	Troubleshooting	25
Playing Back the Images You Have Taken	13	IMPORTANT SAFETY NOTICE.....	26
Changing the Display on the Playback Screen	13	Camera Care.....	27
Printing a Photo.....	14	Bluetooth® Device Cautions	28
About the Remaining Film Sheets Display	15		
Adding Effects to Your Photos	15		
Selecting a Lens Effect	15		
Selecting a Film Effect.....	16		
Specifying a Film and Lens Effect Combination	16		
Setting an Effect Combination	16		
Using your Effect Combinations	16		

Before Using the Camera

Before using the camera, check the following.

Supplied Accessories

- Shoulder strap (1)

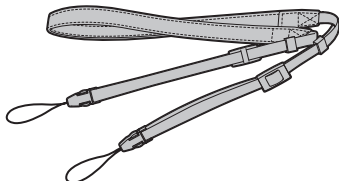

- USB cable for charging (1)

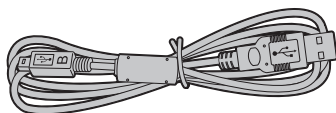

- User's Guide (1)

- Use the strap over your shoulder, not around your neck.
- Make sure the camera strap does not hang over the film ejection slot.
- The battery has not been fully charged at the factory. Be sure to fully charge the battery before using the camera.

Notes on Disposing of the Camera

A built-in lithium ion battery is used for this camera.

When you dispose of the camera, follow your local regulations and dispose of it properly.

Do not attempt to remove the built-in battery. Injury may result.

For proper disposal in the United States at product end-of-life, please contact 1-800-800-3854 Option #1 Help Desk.

For proper disposal in Canada at product end-of-life, please contact 1-800-461-0416.

About This Camera

Main Features

- Provides the best INSTAX image quality to date.*
- Provides up to 100 different expressions with 10 lens effect options and 10 film effect options.
- You can take photos while looking at the LCD Screen and save them to either the main unit or a micro SD card (sold separately).
- Select stored photos to print using the INSTAX Print feature.
- Luxurious, classic design.
- Analog-like operability with lens dial, film dial, and print lever.
- Features a selfie mirror for easy selfies.

Free, Downloadable INSTAX MINI EVO App

Download of the Free INSTAX MINI EVO App is required for the below features.

For instructions on how to download the App, please see page 9.

● Direct Print Function

Transfer a photo from your Smartphone to the camera, and print it on INSTAX MINI instant film (sold separately) using the INSTAX Print feature. Before transferring the photo, you can use the INSTAX MINI EVO App to rotate it, enlarge it or reduce its size.

● Remote Shooting Function

Control the camera with your Smartphone for remote shooting of photos.

● Printed Image Transfer Function

Send images that were previously printed with the camera to the INSTAX MINI EVO App and save them as INSTAX frame images on your Smartphone. See "Using the Playback Menu" (p. 23).

*As of December 2021

Part Names

Front

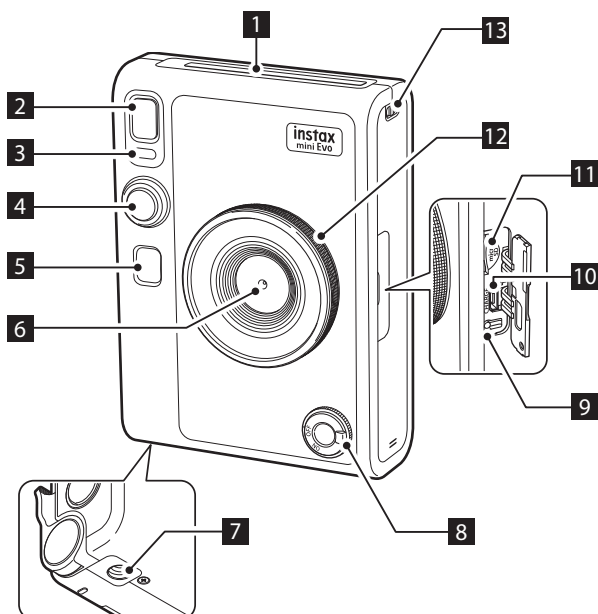

Rear

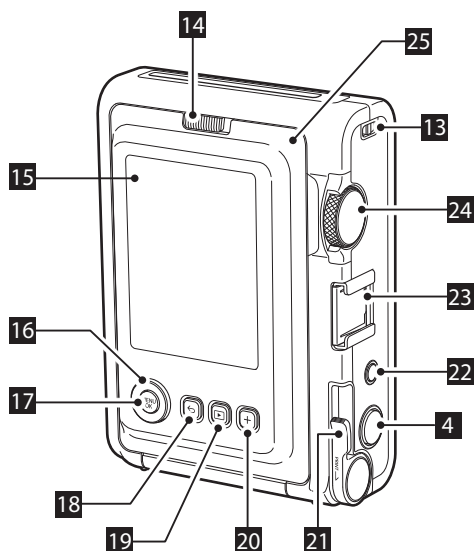

1 Film ejection slot

The exposed INSTAX MINI instant film will be ejected from the film ejection slot during printing.

2 Flash

The flash operates depending on the setting. You can also set the flash to not operate.

3 Self-timer lamp/Charging lamp

The self-timer lamp/charging lamp blinks when you take a photo with the self-timer. Also, it lights up during charging and turns off when charging is complete.

4 Shutter button

Press the shutter button halfway to focus on the subject. Then press it fully to operate the camera shutter and take a photo. Press the shutter button in Playback Mode to switch to Shooting Mode.

5 Selfie mirror

Use the selfie mirror to check your framing before taking a selfie.

6 Photo Lens

This is the lens used to take photos. Make sure that your fingers do not obstruct the lens during shooting.

7 Tripod hole

You can attach a tripod (sold separately) by using this hole.

8 Power switch

Turn the power switch clockwise to turn on the power. Turn it counter-clockwise to turn off the power.

9 Reset button

If the camera is not operating properly, press this button to force the camera to turn off. After pressing the reset button, turn the power switch off and then on again to start the camera. Do not use the reset button while the camera is operating normally. Doing so may cause the photo data to be erased.

10 USB port (micro USB Micro-B)

This is the USB port for charging the camera using the provided charging cord. The USB port cannot be used for data transfer.

11 Micro SD card slot

This is the slot for a micro SD card (sold separately).

12 Lens dial

Turn the lens dial to switch between 10 different lens effect options.

13 Strap hook

Pass the cord on the strap through the strap hook to attach the strap.

14 Film door lock

Slide the film door lock to the right to unlock and open the film door.

15 LCD Screen

You can preview the image before shooting or printing and view the image after it has been captured, on the LCD Screen. Also, menus are displayed on the LCD Screen based on the user operation.

16 Select buttons 

Use the select buttons to select menu items and to use the functions displayed on the LCD Screen.

17 MENU/OK button

During shooting or playback, press the MENU/OK button to display the menu on the LCD Screen. This button is also used to confirm menu items.

18 ↶ (Back) button

Press the ↶ (Back) button to return to the previous screen from the menu currently displayed on the LCD Screen. This button is also used to cancel photo printing.

19  (Playback) button

Press the  (Playback) button to display the photos you have taken on the LCD Screen. When in Shooting Mode, this button is also used to switch to Playback Mode.

20 + (Function) button

Press the + (Function) button in Shooting Mode to check the current effects used on the LCD Screen. You can also save and use effects.

21 Print lever

Print the image displayed on the LCD Screen.

22 Effect reset button

Return both the lens and film effects to normal.

23 Accessory shoe

This is the mounting connector for camera accessories.

24 Film dial

Turn the film dial to switch between 10 different film effect options.



25 Film door

When loading/unloading an INSTAX MINI instant film pack (sold separately), slide the film door lock to unlock the film door and lift it open. Do not open the film door until you have used up the instant film pack.

LCD Screen

When the camera is turned on, the shooting screen appears on the LCD Screen.

- To switch from the shooting screen to the playback screen, press the  (Playback) button.
- To switch from the playback screen to the shooting screen, press the Shutter button fully.

If you press  (Back) while the shooting screen or playback screen is displayed, the following information will appear on the LCD Screen. To return to the shooting screen or playback screen, press  (Back) again.

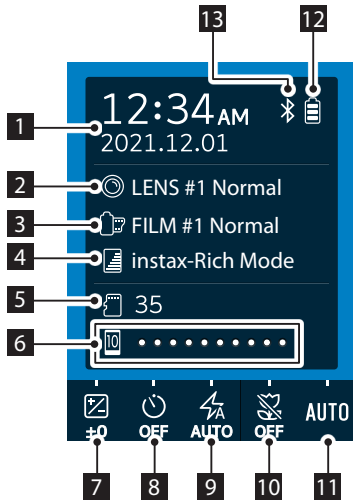

Shooting screen



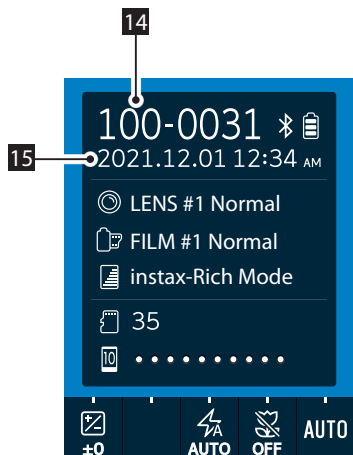

Playback screen







- 1 Current date and time
- 2 Lens effect
- 3 Film effect
- 4 Print quality mode
- 5 Number of shots available*1
- 6 Film remaining indicator
- 7 EXPOSURE
- 8 SELF-TIMER
- 9 FLASH
- 10 MACRO
- 11 WHITE BALANCE
- 12 Battery remaining indicator
- 13 Bluetooth connection status indicator
- 14 Frame number
- 15 Shooting date and time

*1  (Camera) is displayed when the internal memory is used. When the number of shots available is 10 or less, the icon is displayed in red.  (Memory card) is displayed when a memory card is used.

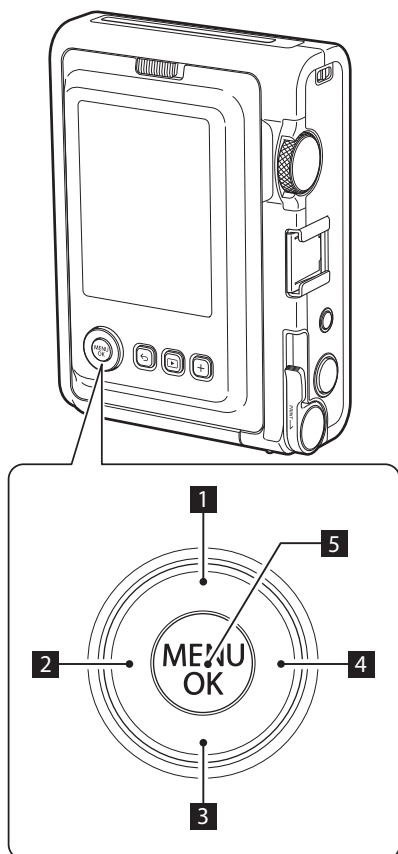
Using the Select Buttons

The  (Up/Down/Left/Right) buttons are used to select menu items and to use the functions assigned to the  buttons. The [MENU/OK] button is used to display menus and make selections.



- 1  Move (up).
- 2  Move (left).
- 3  Move (down).
- 4  Move (right).
- 5 Determines which menu item is displayed or selected.

Attaching the Shoulder Strap

Follow the steps below to attach the shoulder strap to the camera body.

- 1 Insert one end of the shoulder strap through the strap hook on the camera.

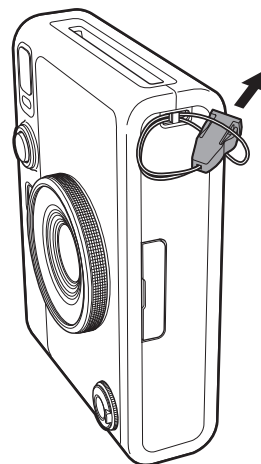

- 2 Attach the strap body to the end of the strap.

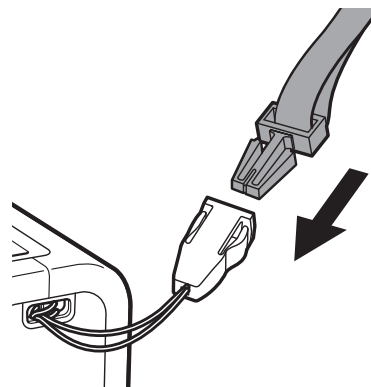

- 3 Attach the other end in the same manner.

- The shoulder strap should be worn on the shoulder, not hanging around the neck.
- Make sure the shoulder strap does not hang over the film ejection slot or over the camera lens.

Charging the Battery

- ❗ Turn off the camera before charging the battery. Battery will not charge if the camera is powered on.
- ❗ Be careful to properly attach cable as indicated.

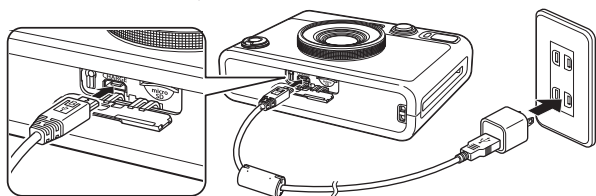

Connect the camera and a USB AC adapter supplied with your Smartphone using the supplied USB cable, then connect the USB AC adapter to an indoor power outlet.

Charging time is approximately 2 to 3 hours.

Charging Status Indication

While charging	Self-timer lamp lights up.
Charging finished	Self-timer lamp goes off.
Charging error	Self-timer lamp flashes.

When charging from a PC:

- Connect the camera directly to the PC using the supplied USB cable, not through a USB hub or keyboard.
- If the PC goes into hibernation (sleep mode) while charging, charging will be stopped. To continue charging, wake up the PC from hibernation (sleep mode) and reconnect the USB cable.
- Depending on your PC's specifications, settings, or condition, it may not be possible to charge the camera battery from your PC.

- It is not possible to remove the battery.
- The battery has not been fully charged at the factory. Be sure to charge the battery before using the camera.
- Please refer to "Camera Care" for precautions regarding the battery. (p. 27)

Power On/Off

Turn the power switch to the right to turn on the power.

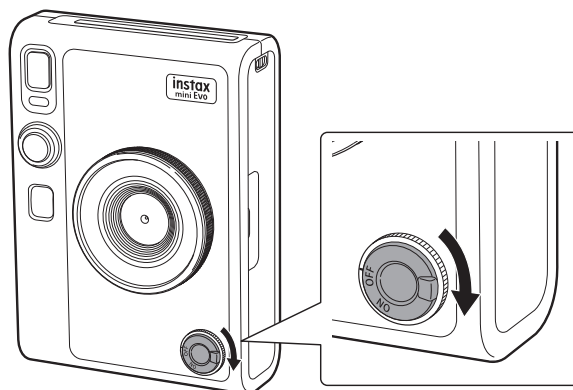



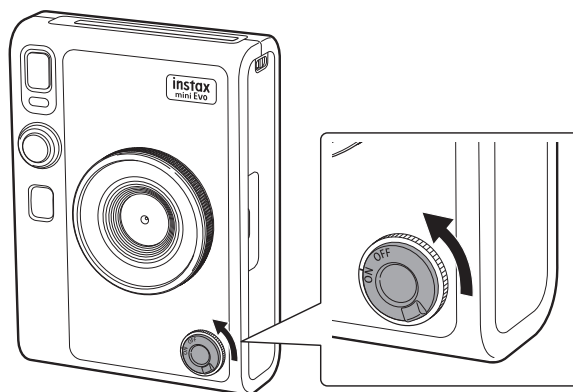

Turn the power switch to the left to turn off the power.





- If you do not operate the camera for a certain period of time, it will automatically turn off. If the camera turns off automatically, turn the power switch off and then on again to turn it on.
- You can also adjust the time until the camera turns off. (p. 22)

How to Check the Battery Level

Press  (Back) on the shooting or playback screen to display the remaining battery charge on the LCD Screen.

Display	Remaining battery charge
	Sufficient battery charge remaining.
	Less than half of battery charge remaining. Recharging the battery is recommended.
	Low battery charge. Recharge the battery as soon as possible.

- When the battery charge is low, an icon () will also appear in the lower right corner of the LCD Screen.
- When the battery is completely depleted, an icon () will appear in the middle of the LCD Screen and the power will turn off.

To return to the shooting screen or playback screen, press  (Back) again.

Configure the Initial Settings

When you turn on the camera for the first time after purchase, you will be automatically prompted to set the language, the date and time, and to pair your Smartphone.

Before pairing registration, install the INSTAX MINI EVO App on your Smartphone.

- If you are using an Android OS Smartphone, search for INSTAX MINI EVO on Google Play and install it.
*Requirements for Android OS Smartphones: Android version 7 or later and have Google Play installed.
 - If you are using an iOS Smartphone, search for INSTAX MINI EVO in the App Store and install it.
*Requirements for iOS Smartphones: iOS version 12 or later
- Depending on your Smartphone model, you may not be able to use the Smartphone App even if you have installed it and meet the above operation requirements.

This setting can be set at a later time. If you want to set or re-set it later, set it from [言語/LANG.], [DATE/TIME], and [BLUETOOTH SETTINGS] in the setup menu.

1 Turning on the power.

- When you turn on the camera for the first time after purchase, the language setting screen will appear.

2 Select the language you want to use, and then press [MENU/OK].

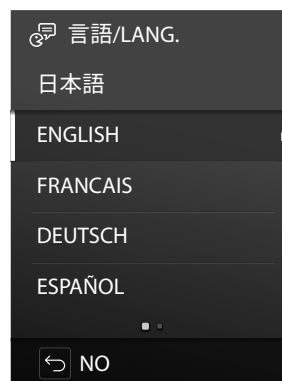

- 3** Set the year, month, and date in that order, and then press [MENU/OK].

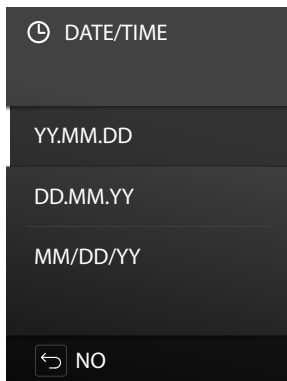

- 4** Set the year, month, day, hour, and minute, and then press [MENU/OK].

Press ◀▶ to select the item to be set (year, month, day, hour, minute) and then press ▲ and ▼ to select the number to be set.

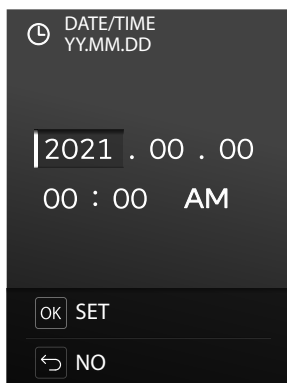

Next, configure the pairing settings.

- 5** Press [MENU/OK].

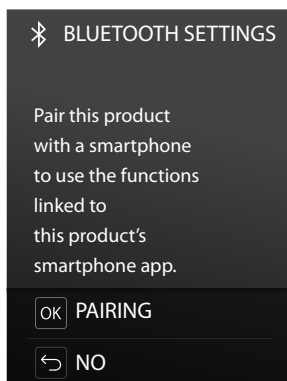

- If you do not want to configure the pairing settings, press ◀ (Back) to exit the initial settings.

- 6** Launch the INSTAX MINI EVO Smartphone App and tap [SETTINGS].

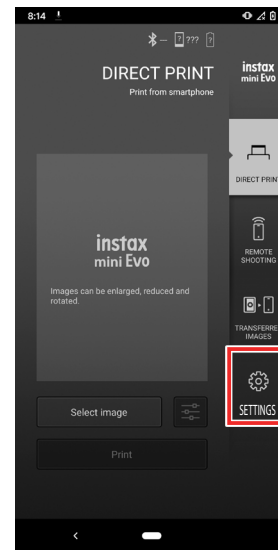

- 7** Tap [Bluetooth settings] on the Smartphone App.

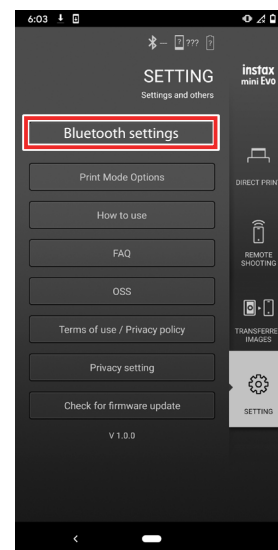

- 8** Tap [Connect] on the Smartphone App once the camera's OWN NAME appears.

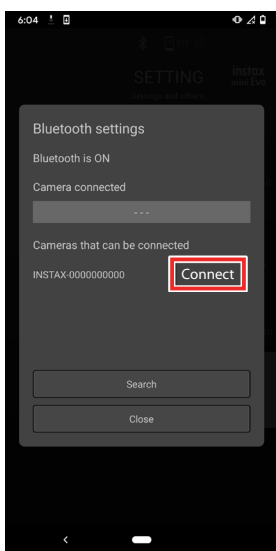

- To check the camera's OWN NAME, display the shooting menu on the camera (p. 22). Then, select [BLUETOOTH SETTINGS], [INFORMATION], and [OWN NAME] in this order.

- 9** Allow pairing.
10 Confirm that pairing registration has been completed.

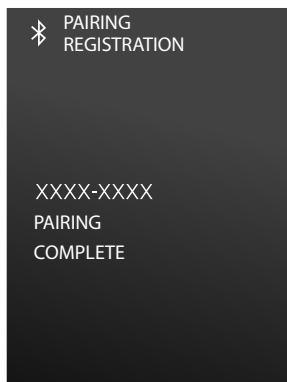

When pairing registration is complete, the screen switches to the shooting screen.

Loading/Unloading the INSTAX MINI™ Instant Film Pack

Loading the INSTAX MINI instant film pack

- 1** Slide the film door lock and open the film door.

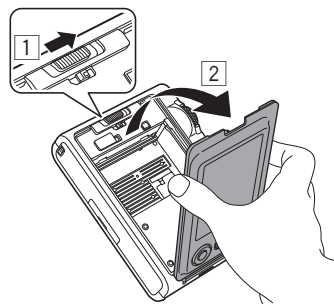

- 2** Insert an INSTAX MINI instant film pack by aligning the yellow marks.

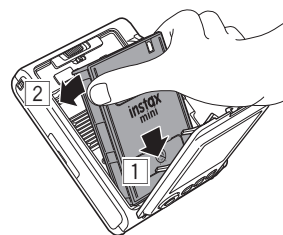

- 3** Close the film door.

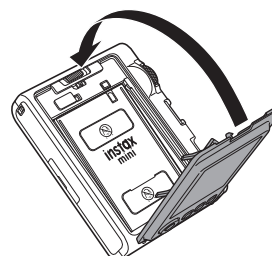

- 4** Remove the black film cover that is automatically ejected from the camera.

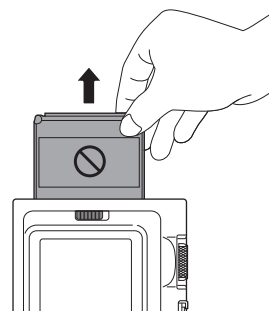

Unloading a Used INSTAX MINI instant film pack

- 1 Slide the film door lock and open the film door.

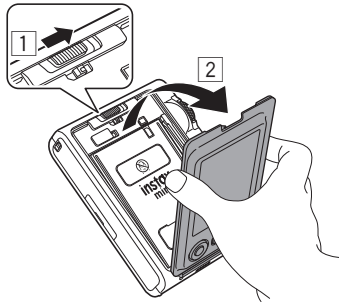

- 2 Grasp the rectangular holes on the film pack, then pull film pack out from the camera. Properly dispose of used film pack.

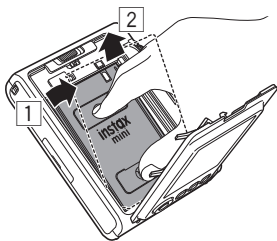

Basic Shooting and Playback

Taking Photos

This section explains the basic steps to take photos.

- 1 Turn on the power.
- 2 Set effects and other settings as desired.
- 3 Compose the photo.
Press or to adjust the composition. Press to take a closer image of a distant subject, or press to take an image of a farther area.
- 4 Press the Shutter button halfway to bring the subject into focus.

When the subject is in focus:



A "beep" is heard and a green AF frame appears in the center of the LCD screen.

When [FACE DETECTION] is enabled, a green AF frame appears over the face of the person when the camera recognizes their face. (p. 22)

When the subject is NOT in focus:

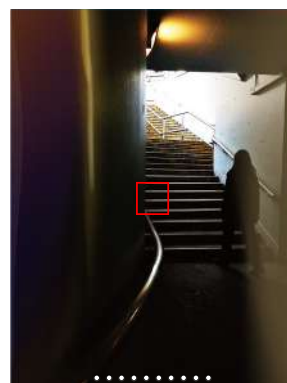

A red AF frame appears in the center of the LCD screen. Change the composition or use AF/AE lock. (p. 20)

5 Hold the Shutter button halfway down and then press it in (all the way down) to shoot the photo.

After taking a photo, the image is stored in the internal memory or on the memory card.

- See "Printing a Photo" for the procedure to print photos you have taken. (p. 14)

- When taking a photo, hold your arms tightly against your body and hold the camera firmly with both hands.
- Be careful not to touch the camera lens when you press the Shutter button.
- When fully pressing the Shutter button, press it gently to prevent the camera from moving and causing the photo to blur.
- Be careful not to let your fingers or the shoulder strap cover the flash or lens.
- In dark or backlit conditions, the flash may fire when the Shutter button is pressed fully. You can change the flash settings to prevent the flash from firing. (p. 18)

Precautions regarding the internal memory

- If the internal memory is full, the shutter will not release and you will not be able to take photos. Delete images or use a memory card.
- If the camera malfunctions, images in the internal memory may be damaged or lost.
- We recommend that you copy important images to another media (hard disk, CD-R, CD-RW, DVD-R, etc.) for backup.
- If you send the camera in for repair, we cannot guarantee the images will be saved in the internal memory.
- When the camera is repaired, we may need to check the images in the internal memory.

Playing Back the Images You Have Taken

You can play back the images you have taken on the LCD Screen.

- 1 Turn on the power**
- 2 Press [RECALL] (Playback) to display the last photo you took.**
The last photo you took is displayed.
- 3 Press [LEFT] or [RIGHT] to select the image you want to view.**
Press the Shutter button fully to return to the shooting screen.

Changing the Display on the Playback Screen

You can zoom in on an image or change the number of frames displayed on the LCD Screen.

To Zoom In on an Image

- 1 Press [LEFT] or [RIGHT] to select the image you want to view.**
- 2 Press [ZOOM IN] or [ZOOM OUT].**
The zoom in/out screen appears.

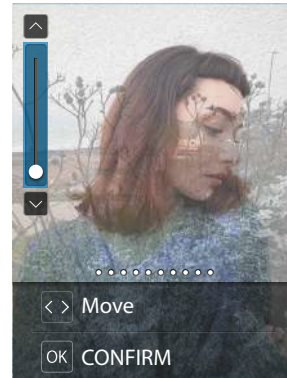

- 3 Press [ZOOM IN] or [ZOOM OUT] to zoom in or out on the image.**

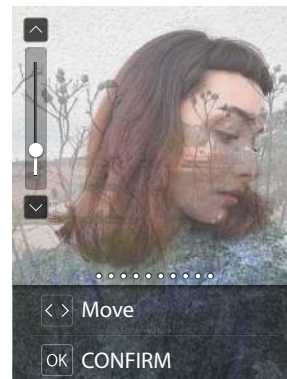

When you press [LEFT] or [RIGHT] on the zoom in/out screen, the screen switches to the move screen, and you can press [LEFT] or [RIGHT] to move the screen position. To return to the zoom in/out screen, press [BACK].



- 4 Press [MENU/OK] to print a zoomed-in or zoomed-out image.**

■ Changing the Number of Frames Displayed

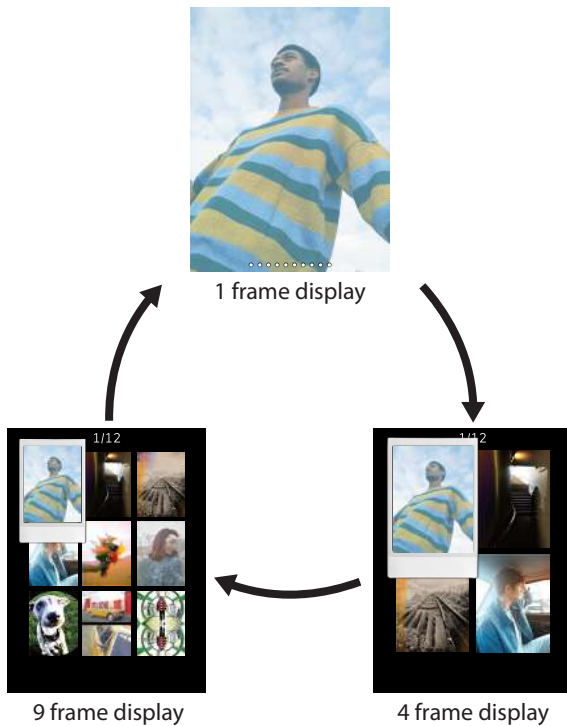
When the playback screen is displayed, press  (Playback) to change the number of frames displayed.



Printing a Photo

- 1 Press the  (Playback) button.
- 2 Press  or  on the Select button to select the photo you want to print.
- 3 You can enlarge the photo or make other edits before printing.
- 4 Turn the print lever.

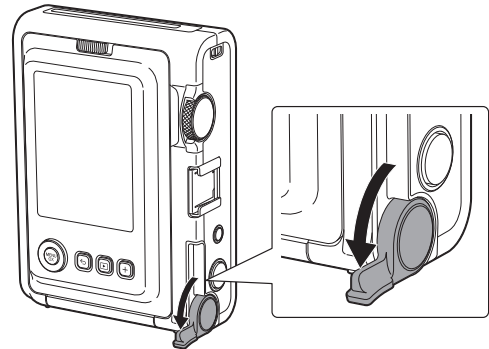

- 5 Use only INSTAX MINI instant print film. After the sound of the film ejecting stops, remove the ejected film from the camera by the film edge.

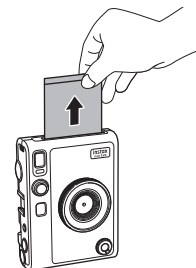

CAUTION

Be careful not to let your fingers or the camera strap get caught in the film ejection slot.

About the Remaining Film Sheets Display

The number of remaining film sheets is indicated by a white dot at the bottom of the screen. Each time you print an image, this dot turns gray. When there are only two film sheets remaining in your loaded film pack, the dot turns red.



10 sheets remaining display

2 sheets remaining display

0 sheets remaining display

- For details on film handling, see the instructions provided with the INSTAX MINI instant film pack.
- Film develops in about 90 seconds (time may vary with temperature).

Adding Effects to Your Photos

Selecting a Lens Effect

Follow the steps below to select a lens effect.

- 1** Display the shooting screen.
- 2** Rotate the Lens dial to select the lens effect.

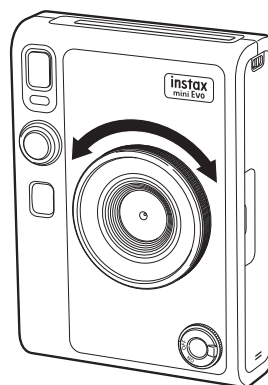

The following screen appears.



- To remove the applied lens effect, select [Normal] from the lens effect menu.
- Press the Effect reset button to cancel the applied lens and film effects.

You can also press the + (Function) button to set your favorite lens and film effect combinations.

Selecting a Film Effect

Follow the steps below to select a film effect.

- 1 Display the shooting screen.
- 2 Turn the Film dial to select the desired film effect.

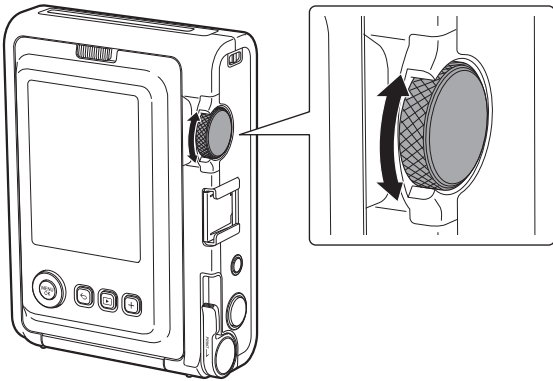

The following screen appears.



- To remove the applied film effect, select [Normal] from the film effect menu.
- Press the Effect reset button to cancel the applied lens and film effects.

You can also press the + (Function) button to set your favorite lens and film effect combinations.

Specifying a Film and Lens Effect Combination

You can set a combination of your favorite lens and film effects. You can use a saved effect combination by pressing the + (Function) button.

Setting an Effect Combination

- 1 Display the shooting screen.
- 2 Rotate the Lens dial to select the desired lens effect.
- 3 Turn the Film dial to select the desired film effect.
- 4 Press the + (Function) button.
- 5 Press [MENU/OK].
- 6 Press ◀ or ▶ to select [Favorite[1]] to [Favorite[3]].
Up to three effect combinations can be set.
- 7 Press [MENU/OK].
The effect combination is set.

Using your Effect Combinations

- 1 Display the shooting screen.
- 2 Press the + (Function) button twice.
- 3 Press ◀ or ▶ to select one of the saved 3 Favorites.
- 4 Press [MENU/OK].
The effect combination is applied.





Miscellaneous Actions

Changing the Brightness of the Image

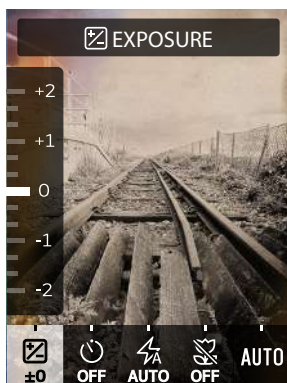
Adjust the brightness of the image. Use this function when the subject is too bright or too dark, or when there is much contrast (difference between light and dark) between the subject and the background.

- 1 Press  or  until [EXPOSURE] appears on the shooting screen.





- 2 Press  or  to correct the exposure.
 - Press  to correct the exposure to the + side to brighten the entire image.
 - Press  to adjust the exposure to the - side to darken the entire image.
- 3 Press the Shutter button all the way down.

Using the Self-Timer to Take Photos

Use this function to take a group photo including the photographer or to prevent the camera from moving while the Shutter button is pressed.

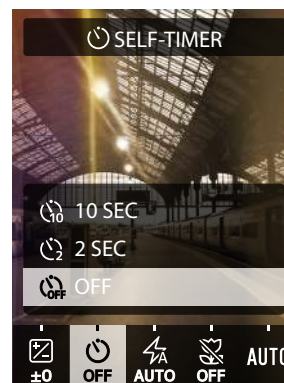
- 1 Press  or  until [SELF-TIMER] appears on the shooting screen.



- 2 Press  or  to select [2 SEC] or [10 SEC]. The icon corresponding to the set self-timer appears in the center of the screen.
 - If you do not want to set a self-timer, select [OFF].
- 3 Press the Shutter button all the way down. The countdown starts.

When [2 SEC] is selected:

When you press the Shutter button, the self-timer light flashes for 2 seconds before taking the photo.

When [10 SEC] is selected:

When you press the Shutter button, the self-timer light lights up and starts flashing three seconds before taking the photo.

To cancel the self-timer halfway through, press  (Back).

Taking Photos with the Flash

Use the flash when taking photos at night or in a dark room. You can also set the camera so that the flash does not fire.

- 1 Press or until [FLASH] appears on the shooting screen.

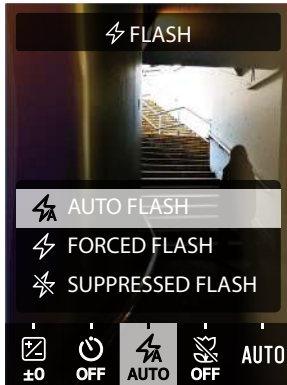

- 2 Press or to select the flash setting.
 - For more information on flash settings, see “Types of Flash” below.

- 3 Press the Shutter button all the way down.

• If you press the Shutter button while the flash is charging, the self-timer light will flash and the shutter will not release.

■ Types of Flash

AUTO FLASH

The flash will fire automatically when the surroundings are dark. This setting applies to most situations.

FORCED FLASH

The flash will fire regardless of the brightness of the surroundings. Use this setting when the subject is dark due to backlighting.

SUPPRESSED FLASH

The flash will not fire even if the surroundings are dark. This setting is suitable for shooting in places where flash photography is prohibited. When shooting in dark places without using the flash, it is recommended to steady the camera on a table or similar surface.

Taking Macro Photos

Use macro shooting when you want to get close to the subject.

- 1 Press or until [MACRO] appears on the shooting screen.

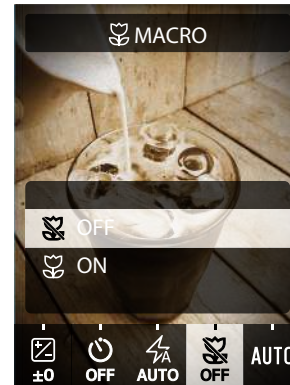

- 2 Press or and select [ON].
- 3 Press the Shutter button all the way down. Macro shooting is performed.

Matching the Light Source when Taking Photos

By setting the white balance to match the light source, such as sunlight or artificial lighting, you can shoot with colors closer to real life.

- 1 Press or until [WHITE BALANCE] appears on the shooting screen.



- 2 Press or to select one of the settings.
 - For details on setting the white balance, see “Types of White Balance” below.
- 3 Press the Shutter button all the way down.

Types of White Balance

AUTO

The camera sets the white balance automatically. AUTO is recommended for normal shooting.

FINE

For outdoor shooting in sunny weather.

SHADE

For shooting on cloudy days or in the shade.

FLUORESCENT LIGHT-1

For shooting under daylight fluorescent lighting.

FLUORESCENT LIGHT-2

For shooting under daylight white fluorescent lighting.

FLUORESCENT LIGHT-3

For shooting under white fluorescent lighting.

INCANDESCENT

For shooting under light bulbs and incandescent lamps.

Taking a Photo of Yourself (Selfie)

You can use the selfie mirror to take photos of yourself.

- 1 Hold the camera securely so that your face comes 30 to 50 cm away from the end of the lens.
 - Hold the camera securely.

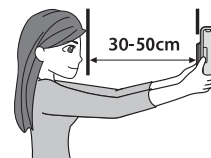

- 2 Use the selfie mirror next to the lens to confirm your composition and then take a photo.

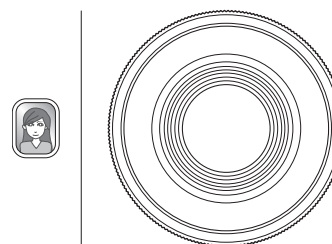

• Do not stare at the flash when taking photos. Looking at the flash while taking a photo may cause temporary visual impairment.

Using AF/AE Lock to Take Photos

When taking a photo, pressing and holding the Shutter button halfway to lock the focus is called "AF Lock," and pressing and holding the Shutter button to lock the brightness is called "AE Lock." This is useful when you want to take a photo where the subject is not in the center of the screen.

- 1 Press the Shutter button halfway to bring the subject into focus or to change the composition.**
- 2 Press the Shutter button fully to take the photo.**

It is recommended that you use AE/AF lock when taking photos of the following objects, as they may be difficult to focus on.

- Shiny objects, such as mirrors and car bodies
- Subjects that are moving at high speed
- Subjects on the other side of glass
- Dark objects, such as hair or fur, that absorb light rather than reflect it
- Insubstantial objects such as smoke or flames
- Subjects with little difference between light and dark (for example, a person wearing clothes the same color as the background)
- When there is a large contrast difference in the AF frame and the subject is in that area (for example, a subject in front of a high-contrast background)

Printing from Print History

You can display images that you printed previously and view the settings (image effects, etc.) used at that time.

You can print the images you have taken by following the steps below.

- 1 On the playback screen, press [MENU/OK].**
The playback menu appears.
- 2 Press ◀ or ▶ to select [PRINT HISTORY].**
- 3 Press [MENU/OK].**
- 4 Press ◀ or ▶ to select the image you want to print.**



- 5 Turn the Print lever.**
Printing starts.

To cancel printing halfway through, press ⏪ (Back).

- 6 After the sound of the film ejecting stops, remove the ejected film from the camera by the film edge.**

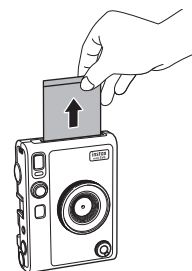

CAUTION

Be careful not to let your fingers or the shoulder strap cover the Film ejection slot.

Using the Memory Card

The camera's internal memory can store about 45 still images, but you can store more images by using a memory card (sold separately). You will also need a memory card to upgrade the firmware.

Precautions Regarding Memory Cards

- This camera is compatible with micro SD cards and micro SDHC cards. Using other types of memory cards may cause damage to the camera.
- Memory cards are small and may be accidentally swallowed by infants. Keep them out of the reach of infants. In the unlikely event that an infant swallows a memory card, consult a physician immediately.
- **Do not turn off the camera or remove the memory card during formatting or while recording/deleting data. The memory card may be damaged.**
- Do not use or store memory cards in an environment that is prone to strong static electricity or electrical noise.
- Inserting a memory card charged with static electricity into the camera may cause the camera to malfunction. If this happens, turn the camera off and then on again.
- Do not carry a memory card in the pocket of your pants. A strong force may be applied when you sit down, which may cause the memory card to break.
- The memory card may become hot to the touch after prolonged use, but this is normal.
- Do not put any labels on memory cards. If the label comes off, it may cause the camera to malfunction.

Precautions Regarding Using a Memory Card on a PC

- Always format an unused memory card or a memory card that has been used on a PC or other device before using it in the camera.
- When a memory card is formatted in the camera and used for shooting and recording, folders are automatically created. Do not use your PC to rename or delete folders or files on the memory card. Doing so may make the memory card in the camera unusable.
- Do not use your PC to delete images on the memory card. Always use the camera.
- If you want to edit an image file, copy or move the image file to a hard disk or similar device, and then edit the copied or moved image file.

Inserting a Memory Card

1 Open the card slot cover.

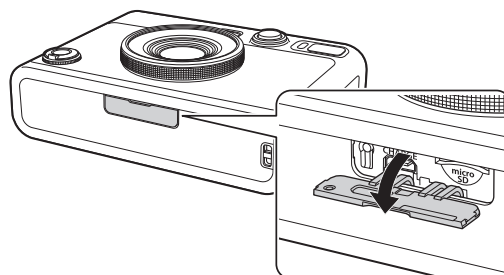

2 Fully insert the memory card into the camera in the correct orientation as shown below until you hear a "click."

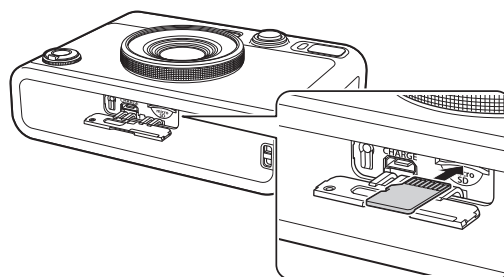

3 Close the card slot cover.

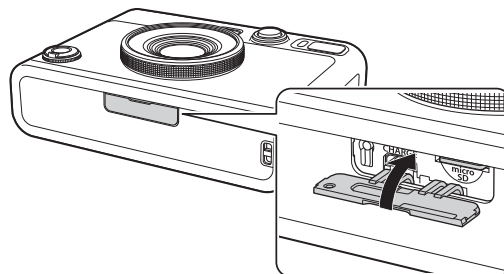

- To remove the memory card, push the card in with your finger and then release your finger gently. The card will be unlocked and is ready to be removed.

If you suddenly release your finger while removing the memory card, the card may pop out. Release your finger gently.

Using the Shooting Menu

You can use the shooting menu to change various settings related to shooting.

- 1 On the shooting screen, press [MENU/OK].
The shooting menu appears.

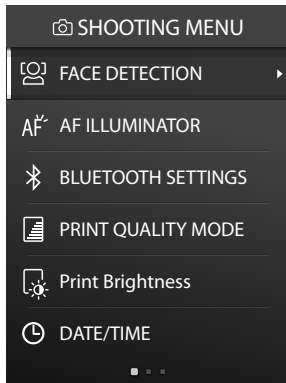

- 2 Press or to select an item.
 - For details on each item, see “Shooting Menu Items” below.
- 3 Press [MENU/OK] to change the setting.
The setting is applied and the display returns to the shooting screen.

■ Shooting Menu Items

[FACE DETECTION]

When [FACE DETECTION] is turned on, the camera detects the person's face and adjusts the focus and brightness to the face instead of the background to make the person brightly stand out.

[AF ILLUMINATOR]

When set to ON, the AF ILLUMINATOR lights up from the time the Shutter button is pressed halfway until the subject is in focus, making it easier to focus on a dark subject.

- Depending on the scene, it may be difficult to get the subject in focus even when the AF ILLUMINATOR is activated.
- The AF ILLUMINATOR may not be fully effective when shooting close to the subject.
- Do not flash the AF ILLUMINATOR close to the human eye.

[BLUETOOTH SETTINGS]

Install the INSTAX MINI EVO Smartphone App on your Smartphone before pairing the camera. Please see page 9 for instructions.

[PAIRING REGISTRATION]:

When connecting the camera to your Smartphone via Bluetooth for the first time, you will need to pair the devices together. Please refer to the following procedure for pairing.

1. Select [BLUETOOTH SETTINGS] from the SHOOTING MENU or the PLAYBACK MENU.
2. Select [PAIRING REGISTRATION] and press [MENU/OK]
3. Press [SETTINGS] on the main screen of the INSTAX MINI EVO Smartphone App
4. Press [Bluetooth settings]
5. Press [Connect]
6. Allow pairing

DELETE PAIRING REGISTRATION:

You can delete the information of a paired Smartphone.

[INFORMATION]:

Displays the Bluetooth address, name of the paired device and other paired device information.

[PRINT QUALITY MODE]

Set to INSTAX-Natural Mode for regular quality, or INSTAX-Rich Mode for richer color representation (factory default).

[Print Brightness]

Set to [x1 (standard)], [x1.5 (semi-bright)], or [x2.0 (bright)].

[DATE/TIME]

Sets the date and time.

[DATE STAMP]

Stamps the date on the image. If you want to erase the date stamped on the image, set to [OFF].

[言語/LANG.]

Sets the language displayed on the LCD Screen.

[SOUND SET-UP]

Sets the volume of the operation sound, shutter volume, and start-up sound.

If you want to turn off the sound, set this to [OFF].

[AUTO POWER OFF]

Sets the time to turn off automatically when the camera has not been operated for a period of time.

[RESET]

Resets the settings to the factory default values.

The date and time set in DATE/TIME will not be reset.

[FORMAT]

Initializes the camera's internal memory or a memory card inserted in the card slot. All stored images will be deleted.

[FIRMWARE UPGRADE]

Upgrades the camera firmware to the most recent release. There are two methods to upgrade the firmware, as shown below. A memory card is required to upgrade the firmware. Please purchase a memory card separately and properly format it before performing the below steps.

● Using the INSTAX MINI EVO Smartphone App

1. Insert the memory card into the card slot of the camera
2. Launch the INSTAX MINI EVO Smartphone App
3. Tap [SETTINGS] on the main screen
4. Click [Check for firmware update]
5. Follow the on-screen instructions

● Using the Camera

1. Download the latest firmware (FPUPDATE.DAT) from the FUJIFILM website below using a PC or other device, and copy it to the root directory of the memory card
https://instax.com/mini_evo/en/support/firmware/
2. Insert the memory card with the copied firmware into the camera card slot
3. Select [FIRMWARE UPGRADE] from the SHOOTING MENU or PLAYBACK MENU
4. Follow the on-screen instructions

Using the Playback Menu

You can use the Playback Menu to change various playback-related settings.

- 1 On the playback screen, press [MENU/OK].
The playback menu appears.

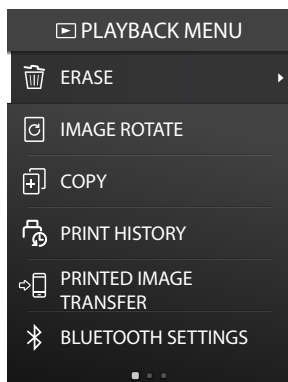

- 2 Press or to select an item.
For details on each item, see "Items in the Playback Menu" below.
- 3 Press [MENU/OK] to change the setting.
The settings are applied and the display returns to the previous screen.

■ Items in the Playback Menu

[ERASE]

Erases images one frame at a time or all frames at once.

[IMAGE ROTATE]

Rotates the image in 90-degree increments.

[COPY]

Copy images from the internal memory to the memory card or from the memory card to the internal memory.

Follow the steps below.

1. Select [COPY] from the Playback Menu
2. Select the copy destination and press [MENU/OK]
3. Select [FRAME] or [ALL FRAMES] and press [MENU/OK]
If you selected [ALL FRAMES], copying starts. If you selected [FRAME], go to step 4.
4. Press or to select the image you want to copy.
5. Press or and select [COPY]
6. Press [MENU/OK]

[PRINT HISTORY]

- Displays up to 50 images that have been printed previously.
- Select an image and turn the Print lever to start printing.
- Press [MENU/OK] to clear the print history frame by frame.

[PRINTED IMAGE TRANSFER]

You can send images that were previously printed with the camera to the INSTAX MINI EVO App and save them as INSTAX frame images on your Smartphone.

For more information on the following items, please refer to the same items in "Using the Shooting Menu". (p. 22)

- BLUETOOTH SETTINGS
- PRINT QUALITY MODE
- Print Brightness
- DATE/TIME
- DATE STAMP
- 言語/LANG.
- SOUND SET-UP
- AUTO POWER OFF
- RESET
- FORMAT
- FIRMWARE UPGRADE

Smartphone App Functions

The following functions are available when connected with the INSTAX MINI EVO Smartphone App.

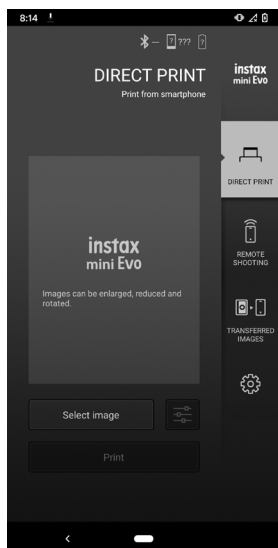

Direct Print Function

This function allows you to send images from your Smartphone to the camera for INSTAX printing onto INSTAX MINI instant print film. You can use the INSTAX MINI EVO App to move, rotate, and zoom into the image before sending it.

Remote Shooting Function

You can set the flash and self-timer of the camera with the INSTAX MINI EVO App and take photos remotely.

Printed Image Transfer Function

You can send images that were previously printed with the camera to the INSTAX MINI EVO App and save them as INSTAX frame images on your Smartphone. The transferred images from the camera appear in Transferred Images. See "Using the Playback Menu" (p. 23).

Specifications

■ Camera Function

Image sensor	1/5-inch CMOS with primary color filter
Number of recorded pixels	2560 × 1920
Storage media	Internal memory, microSD/microSDHC memory card (sold separately)
Storage capacity	Approximately 45 images in internal memory, approximately 850 images per 1 GB in microSD/microSDHC memory card
Recording method	DCF compliant Exif Ver 2.3
Focus distance	f = 28 mm (35 mm film equivalent)
Aperture	F2.0
Auto focus	Single AF (with AF Illuminator)
Shooting distance	3.9 in (10 cm) and beyond
Shutter speed	1/4 second to 1/8000 second (automatic switching)
Shooting sensitivity	ISO100 to 1600 (automatic switching)
Exposure control	Program AE
Exposure compensation	-2.0 EV to +2.0 EV (1/3 EV step)
Metering method	TTL 256 split metering, multi metering
White balance	Auto, Fine, Shade, Fluorescent 1, Fluorescent 2, Fluorescent 3, Incandescent
Flash	Auto flash / Forced flash / Suppressed flash Shooting range with flash: Approximately 19.7 in (50 cm) to 59 in (1.5 m)
Self-timer	2 settings: Approximately 2 seconds / Approximately 10 seconds
Image Effect Options	10 lens effects, 10 film effects Total of 100 lens/film effect combination options

■ Print function

Exposure pixel count	1600 × 600 dots (800 × 600 dots when printed from Smartphone App)
Exposure resolution	25 dots / mm × 12.5 dots / mm (635 × 318 dpi, 40 × 80 μm dot pitch) 12.5 dots / mm when printed from Smartphone App (318 dpi, 80 μm dot pitch)
Exposure gradation	RGB gradation of 256 colors
Interface	Bluetooth Ver. 4.2 (BLE)
Printable image format	JPEG images taken with this unit

Print transmission time	Approximately 16 seconds for transmission and to start printing * Plus 7 seconds when printed using INSTAX-Rich Mode immediately after startup.
Print function	Images in the internal memory or on a memory card (sold separately) can be printed
Reprint	Reprint is possible for images stored in print history (up to 50)

■ Other

Smartphone App Functions	Smartphone image print function, remote shooting function, printed image transfer function, firmware upgrade function
LCD Screen	3.0-inch TFT color LCD screen Pixel count: Approximately 460,000 dots
External interface	Micro USB Micro-B (for charging only)
Power supply	Lithium ion battery (internal type: not removable)
Charging function	Built-in
Possible number of printed images	Approximately 100 (from full charge; number of prints depends on usage conditions)
Charging time	2-3 hours (depending upon environment temperature at time of charging)
Main unit dimensions	3.4 in x 4.8 in x 1.4 in / 87 mm x 122.9 mm x 36 mm (excluding projecting parts)
Main unit weight	Approximately 0.63 lbs (285 g)
Operating environment	Temperature: 41 °F to 104 °F (5 °C to 40 °C) Humidity: 20% to 80% (no condensation)
Film used	FUJIFILM INSTAX MINI instant print film (sold separately)

* The above specifications are subject to change for performance improvement.

Troubleshooting

Please check the following items before considering a problem to be a malfunction. If the problem persists even after taking action, please contact the FUJIFILM service center for repair in your country or visit the website below.

FUJIFILM website: <https://www.fujifilm.com/>

If the following problem occurs...

Problem	Possible causes and solutions
I cannot turn on the camera.	The battery may not be charged. Please charge the camera.
The battery loses its charge quickly.	If you use the camera in a very cold environment, the battery will drain quickly. Please keep the camera warm before shooting.
The camera turned off during use.	The battery level may be low. Please charge the camera.
Charging does not start.	<ul style="list-style-type: none"> • Make sure that the USB power adapter plug is properly connected to the power outlet. • Turn off the camera when charging. If power is on camera will not charge.
It takes too long to charge.	At low temperatures, charging may take some time.
The self-timer lamp flashes while charging.	Charge the battery in a temperature range of 41 °F to 104 °F (5 °C to 40 °C).
I am unable to shoot when I press the shutter button.	<ul style="list-style-type: none"> • Make sure that the power is on. • If the battery level is low, please charge the camera. • If the internal memory or memory card is full, insert a new memory card or delete unnecessary images. • Use a memory card formatted with this unit. • If the contact surface of the memory card (gold part) is dirty, wipe it with a soft, dry cloth. • The memory card may be broken. Please insert a new memory card.
I am unable to focus the camera.	Use the AF/AE Lock to shoot subjects that are difficult to focus on.
The flash does not fire.	Check to see if Suppressed Flash is selected in the Flash settings. If so, select a setting other than Suppressed Flash.
Even though the flash fired, the image is dark.	<ul style="list-style-type: none"> • Check to see if you are far from the subject. Shoot within the range where flash photography is possible. • Hold the camera correctly so that you do not obstruct the flash with your fingers.

Problem	Possible causes and solutions
The image is blurry.	<ul style="list-style-type: none"> • Check to see if the lens has any fingerprints. If so, clean the lens. • Make sure that the AF frame is green before taking a photo. • Make sure to hold the camera steady, particularly in dark environments.
The camera does not work properly.	<ul style="list-style-type: none"> • There may be a temporary malfunction. Please press the reset button. If it still does not work properly, please contact the applicable Fujifilm repair center for repair. • The battery may not be charged. Charge the camera.
The film pack does not load or does not load smoothly.	<ul style="list-style-type: none"> • Please use only FUJIFILM INSTAX MINI instant print film (INSTAX SQUARE™ or INSTAX WIDE™ instant print film can not be used). • Align the yellow mark on the film pack with the yellow camera alignment mark and load it.
The film does not unload.	<ul style="list-style-type: none"> • The film may be misaligned due to shock such as vibration or dropping. Load a new film pack. • If the film is jammed, turn off the camera and turn it on again. If the problem persists, remove the jammed film and then load a new film pack.
Some or all of the finished prints are white.	Do not open the film door until the film is used up. If the film door is opened with film remaining, the film is exposed and the exposed area becomes white.
The print is uneven.	<ul style="list-style-type: none"> • Do not shake, bend, fold or hold the print immediately after it is printed. • Do not obstruct the film ejection slot.

IMPORTANT SAFETY NOTICE

This product has been designed with safety in mind, and to provide safe operation when handled correctly and in accordance with the instructions in this User's Guide. It is important that both the product and the INSTAX MINI instant film pack are handled properly and used only to print photos as instructed in this User's Guide and in the INSTAX MINI instant film pack instructions. For your ease and safety, strictly follow the instructions in this User's Guide. Keep this User's Guide in a safe, convenient place for easy future reference as needed.

WARNING

This symbol indicates danger, which could result in product damage, injury or death. Follow the instructions indicated to avoid damage to the camera or injury.









WARNING

 If one of the following cases occur, immediately unplug the Micro USB cable, turn the camera off and refrain from any further use of the camera:

- The camera becomes hot, emits smoke, has a burnt smell, or otherwise seems abnormal.
- The camera is dropped into water, or foreign objects like water, sand, dirt or metal get inside the camera.

 The camera has a built-in lithium battery. Do not subject it to heat, expose it to an open flame, drop it, or otherwise apply force or impact to it. Doing so may cause the camera to explode, resulting in injury.

WARNING

-  Never attempt to take this product apart. You may be injured.
-  All repairs should be handled solely by Fujifilm. Injury may result from attempts to self-assess or repair this camera.
-  If this product is dropped or damaged so that the outer case becomes cracked or open, do not touch it. Contact Fujifilm.
-  Do not touch any parts which are inside the film door. You may be injured.
-  Never get this product wet or handle it with wet hands. Doing so may result in electric shock and injury.
-  Promptly unplug the Micro USB cable once battery is fully charged.
-  Keep out of the reach of small children. This product could cause injury in the hands of a child.
-  Do not cover or wrap the camera or the AC power adapter in a cloth or blanket, or otherwise place the camera in the sun or an environment where heat may build up. This could distort the casing or cause a fire.



The "CE" mark certifies that this product satisfies the requirements of the EU (European Union) regarding safety, public health, environment and consumer protection. ("CE" is the abbreviation of Conformité Européenne.)

Camera Care

■ Handling the Camera

- ⚠ CAUTION - Do not expose to excessive heat such as sunshine, fire or the like during use, storage, or transportation. An explosion or leakage of flammable liquid or gas could result. Also, ensure proper disposal in accordance with the instructions below.
- ⚠ CAUTION - Do not remove or attempt to remove the lithium battery. Without limitation, do not expose or attempt to expose the camera or the lithium battery to fire or a hot oven. Do not attempt to damage, mechanically crush or cut the lithium battery, as an explosion could result.
- ⚠ CAUTION - Do not subject to extremely low air pressure at high altitude. An explosion or the leakage of flammable liquid or gas could result.

■ Camera Care

1. Do not open the film door until you have used up the loaded instant film pack. Doing so will expose the remaining film, causing the remainder of the film pack to become unusable.
2. Your camera is a precision instrument. Do not get it wet or drop it. Also, do not expose it to sand, dust or dirt.
3. Do not use a strap made for cellular phones or other similar electronic products with your camera. These straps are usually too weak to hold your camera securely. For safety, use only straps designed for and provided with your camera, and use only as specifically intended and instructed.
4. Do not use cleaning products or solvents such as those with bleach or alcohol to remove dirt. Wipe with a damp cloth if and as necessary.
5. In hot weather, do not leave your camera in hot places such as in a car or on the beach. Do not leave it in damp places or places where weather exposure could result.
6. Moth repellent gas such as naphthalene may affect your camera and prints. Store your camera and photo prints in a place where exposure to harmful cleaning or other household elements will be avoided.
7. Note that the temperature range within which your camera should be used is 41°F to 104°F (5°C to 40°C).
8. Take great care to ensure that your prints do not violate copyright, image rights, privacy or other personal rights and do not offend public decency. Actions that violate the rights of others, that are contrary to public decency, or that constitute a nuisance may be punishable by law or otherwise legally actionable.

■ Handling the LCD Screen

As the LCD Screen can be easily damaged, ensure the surface is not scratched with solid materials. To avoid the LCD Screen getting damaged, we recommend you attach a protective, clear plastic sheet (sold separately and widely available) on the LCD Screen.

■ Charging the Battery

The battery is not charged at shipment. Charge the battery completely before use.

Charge the battery using the supplied Micro USB cable and the USB Adapter from your Smartphone. Charging times will increase at ambient temperatures below 50°F (10°C) or above 95°F (35°C). Do not attempt to charge the battery in environments with temperatures above 104°F (40°C); at temperatures below 41°F (5°C), the battery will not charge.

■ Battery Life

At normal temperatures, the battery can be recharged about 300 times. A noticeable decrease in the length of time the battery will hold a charge indicates that it has reached the end of its service life.

■ Caution: Handling the Battery

The battery and camera body may become slightly warm to the touch after extended use. This is normal.

■ Required certification markings are located inside the film chamber.

■ Cautions During Printing



Do not shake the camera while printing.

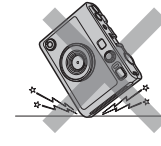

Do not drop the camera while printing.



Do not cover or permit interference with the film ejection slot while printing.

■ INSTAX MINI Instant Film and Print Care

This camera uses INSTAX MINI instant print film, sold separately. See FUJIFILM INSTAX MINI instant film pack use instructions. Follow all instructions for safe and proper use, including:

1. Keep the film in a cool place. Do not leave the film in a place where the temperature is extremely high (e.g., in a closed car) for many hours.
2. Do not puncture, tear, or cut INSTAX MINI instant film. If film becomes damaged, do not use.
3. When you load a film pack, use the film as soon as possible.
4. If the film has been kept in a place where the temperature is extremely high or low, bring it to room temperature before loading or starting to print photos.
5. Be sure to use the film before the expiration or "Use Before" date.
6. Avoid airport checked luggage inspection and other strong X-ray illumination. Such exposure may cause fogging and otherwise affect your unused film. Carrying your camera and film onto an aircraft in your carry-on luggage is recommended. (Check with each airport for more information.)
7. Avoid exposing the developed prints to strong light, and keep them in a cool, dry place.
8. ⚠ Do not puncture or cut the film as it contains a small amount of caustic paste (high alkaline). Never let children or animals put the film into their mouth. Also pay attention so that the paste does not come into contact with skin or clothes.
9. ⚠ If the paste inside the film comes into contact with skin or clothes, immediately wash off with plenty of water. If the paste comes into contact with the eyes or mouth, immediately wash the area with plenty of water and contact a doctor. Note that the alkaline inside the film remains active for about 10 minutes after the photo has been printed.

- **⚠ CAUTIONS on Handling INSTAX MINI Instant Film and Prints**
See below for film activities to be avoided.



Bluetooth® Device Cautions

IMPORTANT: Read the following notices before using this camera's built-in Bluetooth transmitter.

- **Use only as part of a Bluetooth network.**
Do not use in applications requiring a high degree of reliability, for example in medical devices or other systems that may directly or indirectly impact human life. When using the device in computer and other systems that demand a greater degree of reliability than Bluetooth networks, be sure to take all necessary precautions to ensure safety and prevent malfunction. FUJIFILM Corporation and its affiliates do not accept liability for damages resulting from unauthorized use or misuse.
- **Use only in the country in which the device was purchased.**
This device conforms to regulations governing Bluetooth devices in the country in which it was purchased. Observe all location regulations when using the device. FUJIFILM Corporation and its affiliates do not accept liability for problems arising from use in other jurisdictions.
- **Wireless data (images) may be intercepted by third parties.**
FUJIFILM Corporation and its affiliates are not responsible for intercepted transmissions, or for unintended image uses.
- **Do not use the device in locations subject to magnetic fields, static electricity, or radio interference.**
Do not use the transmitter in the vicinity of microwave ovens or in other locations subject to magnetic fields, static electricity, or radio interference that may prevent reception of wireless signals. Mutual interference may occur when the transmitter is used in the vicinity of other wireless devices operating in the 2.4 GHz band.
- **The Bluetooth transmitter operates in the 2.4 GHz band. The standard output is approximately 3.16 mW.**
- **This device operates on the same frequency as commercial, educational, and medical devices and wireless transmitters.**
It also operates on the same frequency as licensed transmitters and special unlicensed low-voltage transmitters used in radio-frequency identification tracking systems for assembly lines and in other similar applications.

- **To prevent interference with other devices operating on the same frequency, observe the following precautions.**
Confirm that the radio-frequency identification transmitter is not in operation before using this device. If you notice that this device causes interference in low-voltage radio-frequency identification tracing systems, contact a FUJIFILM representative.
- **The following may be punishable by law:**
 - Disassembly or modification of this device.
 - Removal of device certification labels.

For customers in the USA:

FCC Statement

This device complies with part 15 of the FCC Rules. Operation is subject to the following two conditions: (1) This device may not cause harmful interference, and (2) this device must accept any interference received, including interference that may cause undesired operation.

For more information, access the website below.

https://instax.com/mini_evo/en/spec.html

CAUTION

This equipment has been tested and found to comply with the limits for a Class B digital device, pursuant to Part 15 of the FCC Rules. These limits are designed to provide reasonable protection against harmful interference in a residential installation. This equipment generates, uses, and can radiate radio frequency energy and, if not installed and used in accordance with the instructions, may cause harmful interference to radio communications. However, there is no guarantee that interference will not occur in a particular installation. If this equipment does cause harmful interference to radio or television, which can be determined by turning the equipment off and on, the user is encouraged to try to correct the interference by one or more of the following measures:

- Reorient or relocate the receiving antenna.
- Increase the separation between the equipment and receiver.
- Connect the equipment into an outlet on a circuit different from that to which the receiver is connected.
- Consult the dealer or an experienced radio/TV technician for help.

Changes or modifications not expressly approved by Fujifilm responsible for compliance could void the user's authority to operate the equipment.

This transmitter must not be co-located or operated in conjunction with any other antenna or transmitter.

The available scientific evidence does not show that any health problems are associated with using low power wireless devices. There is no proof, however, that these low power wireless devices are absolutely safe. Low power wireless devices emit low levels of radio frequency energy (RF) in the microwave range while being used. Whereas high levels of RF can produce health effects (by heating tissue), exposure of low-level RF that does not produce heating effects causes no known adverse health effects. Many studies of low-level RF exposures have not found any biological effects. Some studies have suggested that some biological effects might occur, but such findings have not been confirmed by additional research. This device has been tested and found to comply with FCC radiation exposure limits set forth for an uncontrolled environment and meets the FCC radio frequency (RF) Exposure Guidelines.

Notes on the Grant

To comply with Part 15 of the FCC Rules, this product must be used with a Fujifilm-specified Micro USB cable.

For customers in Canada:

CAN ICES-003(B) / NMB-003 (B)

This device contains licence-exempt transmitter(s)/receiver(s) that comply with Innovation, Science and Economic Development Canada’s license-exempt RSS(s). Operation is subject to the following two conditions:

1. This device may not cause interference.
2. This device must accept any interference, including interference that may cause undesired operation of the device.

The available scientific evidence does not show that any health problems are associated with using low power wireless devices. There is no proof, however, that these low power wireless devices are absolutely safe. Low power wireless devices emit low levels of radio frequency energy (RF) in the microwave range while being used. Whereas high levels of RF can produce health effects (by heating tissue), exposure of low-level RF that does not produce heating effects causes no known adverse health effects. Many studies of low-level RF exposures have not found any biological effects. Some studies have suggested that some biological effects might occur, but such findings have not been confirmed by additional research. This device has been tested and found to comply with ISED radiation exposure limits set forth for an uncontrolled environment and meets RSS-102 of the ISED radio frequency (RF) exposure rules.

Proper Disposal - US and Canada

	<p>Disposal of Electric and Electronic Equipment in Private Households Disposal of used Electrical & Electronic Equipment (Applicable in the European Union and other European countries with separate collection systems)</p>
---	--

This symbol on the product, or in the manual and in the limited product warranty, and/or on its packaging indicates that this product shall not be treated as household waste. Instead it should be taken to an applicable collection point for the recycling of electrical and electronic equipment. By ensuring this product is disposed of correctly, you will help prevent potential negative consequences to the environment and human health, which could otherwise be caused by inappropriate waste handling of this product. The recycling of materials may help to conserve natural resources. For more detailed information about recycling of this product, please contact your local city recycling office, your household waste disposal service or the authorized FUJIFILM dealer from which you purchased the product or contact Fujifilm at the address below. For proper disposal in the United States at product end-of-life, please contact 1-800-800-3854 Option #1 Help Desk. For proper disposal in Canada at product-end-of-life, please contact 1-800-461-0416.

<p>Information for Fujifilm in the United States FUJIFILM North America Corp. 200 Summit Lake Drive Valhalla, New York 10595, USA</p>
--

<p>Information for Fujifilm in Canada FUJIFILM Canada Inc. 600 Suffolk Court, Mississauga, Ontario L5R 4G4, Canada</p>

If you have any inquiries about this product, please contact a FUJIFILM authorized Dealer, or access the website below.
<https://www.fujifilm.com/>

■ **Trademark Information**

The Bluetooth® word mark and logos are registered trademarks owned by the Bluetooth SIG, Inc., and any use of such marks by FUJIFILM is under license.

FUJIFILM, INSTAX, INSTAX MINI, INSTAX SQUARE, INSTAX WIDE and INSTAX MINI EVO are trademarks of FUJIFILM Corporation and its affiliates.

© 2021 FUJIFILM Corporation. All rights reserved.

FUJIFILM

FUJIFILM Corporation

7-3, AKASAKA 9-CHOME, MINATO-KU, TOKYO 107-0052, JAPAN