

Warning:

This appliance is not intended for use by persons (including children) whose physical, sensory or mental capabilities may be different or reduced, or who lack experience or knowledge, unless such persons receive supervision or training to operate the appliance by a person responsible for their safety.

Consult a qualified electrician or service agent if the grounding instructions are not completely understood, or if doubt exists as to whether the appliance is properly grounded.

If the power supply cord is damaged, it must be replaced by the manufacturer, its service agent or similar qualified person in order to avoid hazard.

Children should be supervised to ensure that they do not play with the appliance.

KRIB
BLING

**AUTOMATIC
WASHING MACHINE**

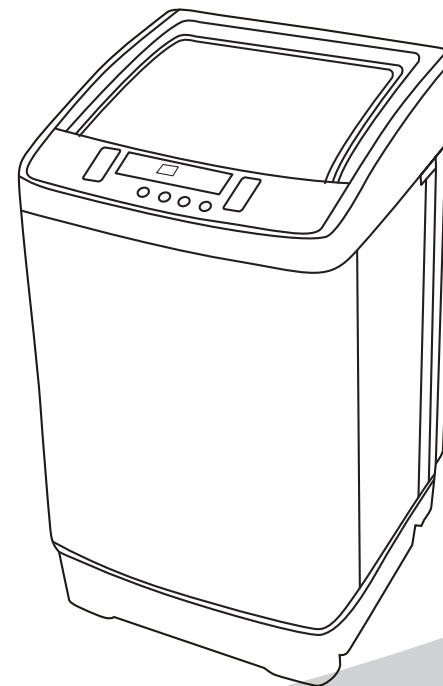

XQB60-201B XQB70-618B

INSTRUCTION MANUAL

For any questions or help, please contact us at teamyoucan@163.com or sunflowerday@aliyun.com

Catalog

Read Before Use

Install guide	
Parts and Bom	1
Notice	2
Installation	4
Further Adjustments	6

Usage guide

Pre-wash	8
Programming and features	9
Wash and Spin	10
Post-wash	11

<u>Troubleshooting...</u>	12
---------------------------------	----

Please pay attention to safety instructions



This product belongs to class I appliance, please pay attention to electricity safety when using!

SAFETY REQUIREMENTS

Ensure that servicing is done by factory authorized service personnel, to minimize product damage or safety issues.

GROUNDING INSTRUCTIONS

This appliance must be grounded. Grounding reduces the risk of electrical shock by providing an escape wire for the electrical current.

This appliance has a cord that has a grounding wire with a 3-prong plug. The power cord must be plugged into an outlet that is properly grounded.

If the outlet is a 2-prong wall outlet, it must be replaced with a properly grounded 3-prong wall outlet. The serial rating plate indicates the voltage and frequency the appliance is designed for.

Troubleshooting

Error Digital Display Information	Error Reason	How to fix
E1 – Water Inlet Fault	<ul style="list-style-type: none"> ● Incoming water has taken over 20 minutes to reach water level. ● The Inlet Valve is blocked or obstructed. ● The Water supply is cut off or the stopcock is open. 	<ul style="list-style-type: none"> ● Check the reason for low water pressure, open and close the cover 1 time to restart operation. ● Remove the blockage from the inlet valve, once done open and close the cover 1 time to restart operation. ● Turn on the water supply or stopcock, once done open and close the cover 1 time to restart operation.
E2 – Drainage Fault	<ul style="list-style-type: none"> ● Water drainage has taken over 5 minutes. ● Drain valve blocked, damaged or faulty. ● Drain pipe is damaged. 	<ul style="list-style-type: none"> ● Reposition the drain pipe for a more smooth water drainage, once done open and close the cover 1 time to restart operation. ● Remove the blockage from the drain valve, once done open and close the cover 1 time to restart operation.
E3- Top Cover Fault	<ul style="list-style-type: none"> ● The cover is open during use. 	<ul style="list-style-type: none"> ● Close the cover.
E4 – Spin Fault	<ul style="list-style-type: none"> ● Clothes are not level or balanced. ● The machine is standing at an incline. 	<ul style="list-style-type: none"> ● Reposition the clothes in the tub so they are balanced and level and close the cover. ● Place the washing machine on a level surface, once done please open and close the cover.
E5 – Water Level Fault	<ul style="list-style-type: none"> ● Water level sensor fault. ● Water Leakage. ● Harness contact is loose. ● Airway tube is loose. 	<ul style="list-style-type: none"> ● Unplug the machine, wait 10 seconds and replug the machine. If issue continues set water level to normal and restart the machine.
E6 – Child Protection	<ul style="list-style-type: none"> ● Machine is Child locked but the cover has been opened. 	<ul style="list-style-type: none"> ● Ensure that your child is a safe distance from the machine and close the cover.
Remarks	If unsolved the problem after use above methods, please contact maintenance dept and professional maintenance personnel, customer can not assemble or disassemble.	

Parts and Bom

Read Before Use

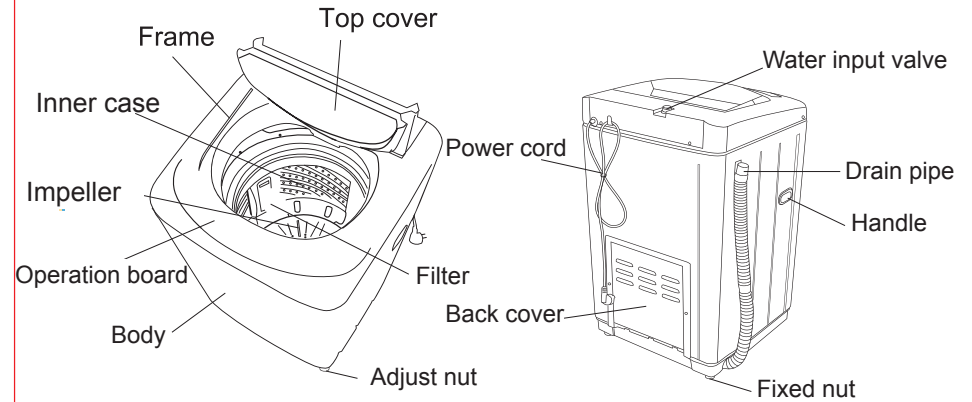

Symbol Notice:

	All operation with this Mark must operate strictly as instruction requirements, or it may cause machine damage or endanger users' life.
	All behavior with this Mark must absolutely prohibited, or it may cause machine damage or endanger users' life.

Accessory

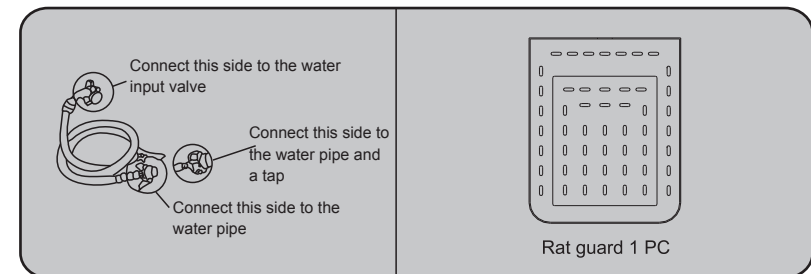

Notice

Read Before Use

Please connect power plug of the machine to the designed electrical 220V socket separately. Do not attach to adapters.

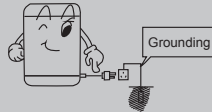

When the machine is in normal use, please keep the machine plugged in. During a power outage or if the machine is not being intended for use, it should be unplugged and the water tap turned off. Please don't unplug or plug the machine with wet hands.



Do not obstruct the power cord, damaged the power cord, put any items on top of the power cord or bend the cord to improper angles. When the power cord or power plug is damaged, it must be repaired by specialist maintenance. Tampering with the cable will void all guarantees.



Don't place the machine in the bathroom or other damp place, and do not put the wet clothes on the operation board. This may let water into the PCB board which may cause an electrical fire.

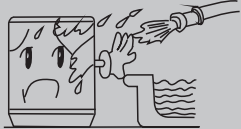

Do not use water at a temperature of more than 50 C.



Please ensure that the vents at the bottom of the machine are well ventilated. Take care especially when placing machine on the carpet.

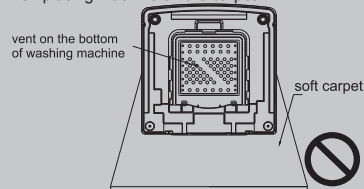

Don't wash raincoats or waterproof clothing, such as a bicycle covers etc. This will cause such items to be damaged.



Don't share a socket with other appliances. If the power plug is damaged or the socket is loose, please do not use and have it repaired by a professional.

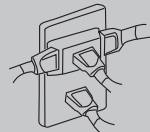

Post-wash

Usage guide

- Each month please clean the Impeller filter to ensure the best performance.
- During clean up, please unplug the power plug from the socket

Filter cleaning

- Must use filter when washing
- Please clean up filter timely

1. Take off the filter
See the pic.

2. Clean the filter

3. Hold on the handle of filter and press on the bottom to put it in.

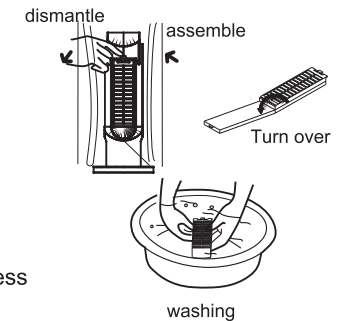

Clean the water inlet filter by brush every 2 months

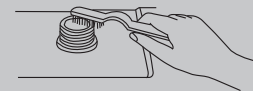

Use wet soft cloth to wipe the dirt on the body

1. Don't directly flushing
2. Use neutral detergent to wipe
3. Don't use thinner, oil, alcohol to wipe

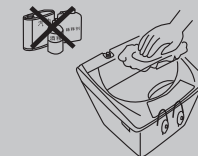

1. Turn off the tap when finish washing
2. please don't store water in the machine, once finish washing please drain up water directly
3. Must unplug first then do maintenance
4. Hang power cord and drain pipe on the hook
5. Wipe the wet surface and inner case by soft and clean cloth, open the top cover for a period of time (about 1 hour) then close.

Wash and Spin

Usage guide

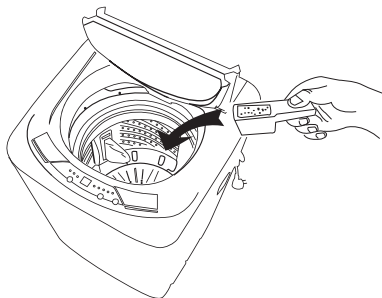

How to use bleach

- Once the water has reached the water level, put the right amount of washing bleach into the container; slowly pour the powder into the tub.
- Clothes with colour or patterns are easy to rub off, it should be avoided also to use bleach. Please ensure you wash whites, with whites only and colours with other colours. Do not mix (if you don't want your whites to no longer be whites. However if you do we suggest you use red for a nice light pink).
- Bleach should not direct contact with the washing.
- Use of bleach method and usage according to bleach instruction.
- Powder type bleach should be melted before using.
- Please note that it is not advisable to use bleach in washing clothes due to potential skin irritations etc.

Please note:

- There is a period of time to start spin dry even if there is no water in the tub.
- Clothing with colours may easily rub off and must be washed separately from other clothes.
- If the water is below the minimum water level the impeller will not turn.

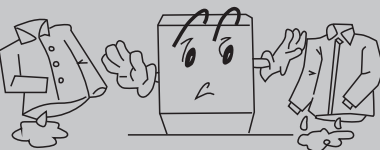

How to use laundry detergent

- Once the water has reached the water level, put the right amount of detergent into the container; slowly pour the powder into the tub. Allow at least 30 seconds to ensure an even dissolve or use the soak function for best results.
- Put in washings and select suitable water level.
- Clothes with colour or patterns are easy to rub off, please read the label before you wash your clothes. Please ensure that you wash whites, with whites only and colours with other colours. Do not mix (if you don't want your whites to no longer be whites! However if you do we suggest you use red for a nice light pink.)

Use laundry detergent in moderation

We recommend that you do not use a high foaming detergent, as it will no doubt make a mess and in extremely high dosages may even enter the control panel and destroy the appliance.

Laundry detergent dosage should refer to the detergent instructions.

Notice

Read Before Use

When washing machine is on working, don't put hands into the inner case. And don't let child climb upon the washing machine.



Do not dismantle, repair and rebuild the machine on your own!

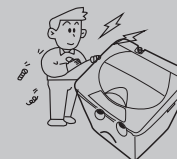

Don't place any hot or heavy objects (such as a pot of hot water) on the washing machine.



Don't wash clothes that with volatile substances (thinner, gasoline, etc.).

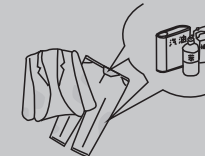

Do not Leave Children without supervision. Certain disabilities, illnesses, persons on medication that can cause dizziness or hallucinations as a side effect, or the intoxicated may not use this.

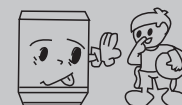

Do not put under direct sunlight; do not put the appliance close to a heating heat source, etc.



Filter must be intact and installed correctly.

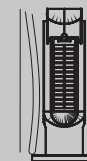

- Before washing or spinning laundry, please check that all foreign matters are out of the pockets or not wrapped in blankets (such as coins, keys, headphones, batteries, sand, hairpins etc).



- Before Laundry, Please check whether the tap open or not and water pipe connect or not.
- Suggest use low foam detergent.

Installation

Read Before Use

Please install and adjust the washing machine according to the requirement of the specifications, this is very important for your safety and correctly use the washing machine.

Install the rat guard

1. Install in front way

Opened the package, put the washing machine back down gently on soft surface (such as terry cloth, carpet), Insert the rat guard from front to back and you can hear a crack click when it installed in place. Then gently lift it up like the Picture.

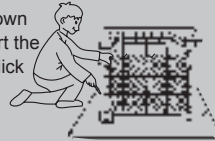

2. Install in back way

Opened the package, put the washing machine back down gently on soft surface (such as terry cloth, carpet), Insert the rat guard from back to front and you can hear a crack click when it installed in place. Then gently lift it up like the Picture.

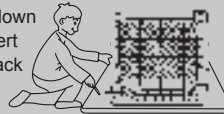

Adjust the Installation position

Please leave more than 20 mm between washing machine and the wall, maximum slope Angle is 2° on bearing surface. Ground tilt or uneven may cause washing machine running unstable or stop in midway, please use the following method to adjust:

● Determine horizontal

Use a bubble level tool or a free bubble level mobile phone app to confirm whether the washing machine is horizontal. If you do not have access to either place a straw or needle on the machine and see if it rolls.

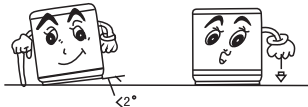

Before installation, remove the bottom foam and plastic stent.

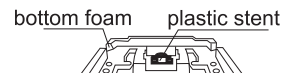

● Adjust the adjustable nut

1. Lift up the machine adjustable side, loosen the adjustable nut, rotate it and make machine horizontal.
2. After stable adjustment, tighten the adjustable nut.

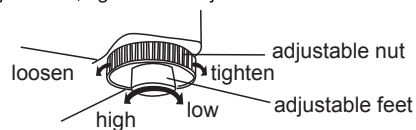

Programming and features

Usage guide



*The washing capacity means the maximum weight of washing or spinning for a wash.

*The thickness of the fabric, size or kinds, will affect the actual washing capacity.

*Do not select high water level when fabric weight is below 1.0kg

* Please select the high water level when you believe it is suitable. It will not clean clothes better if you use a high water level for a small amount of clothes so please try and save water.

The reference weight of washing

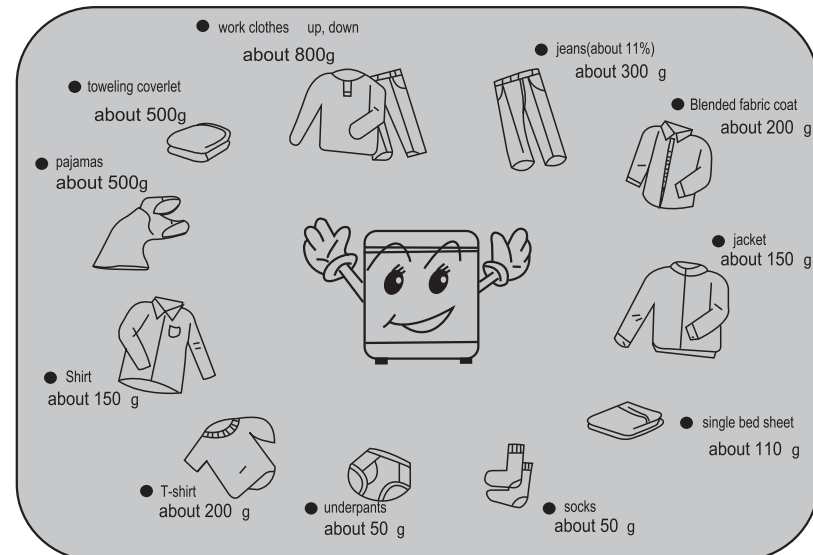

Pre-wash

Usage guide



Please pay attention to the following matters before washing

Preparation before washing

1. Connect water pipe well, turn on the tap.
2. Plug into the socket
3. Put down the drain pipe

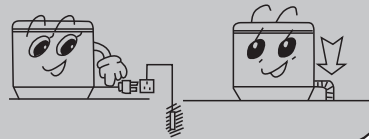

- a. Ensure no item in the clothes pocket (such as screw, coin etc.)
- b. Turn clothes over to wash, so that chip or line does not adhere to the surface of clothes during washing.
- c. When do fine cleaning, like Women's underwear, thin nylon and polyester materials, please put it into washing bag.
- d. Tight loose belt in clothing and pull on the zipper.
- e. To get rid of the mud and sand on clothing before washing.
- f. clothes that easy to float on, please put it in the bottom, in addition, when floating, please stop and press it into the washing liquid.
- g. Please separate thick clothes and thin clothes in washing.
- h. Inappropriate to wash down jacket and not bibulous clothing, if needed, please select the low water level and do single washing.
- e. It is forbidden to wash fur blankets and electric blanket.

Spin drying can lead to shrinkage and deformation of the wool fabric.



1. Please don't use the spin function on wool.
2. It is forbidden to spin dry down jacket and other light weight but bulky clothing to avoid danger. Please check the washing label of your clothes item before you wash.

Notice



It is forbidden to wash fur blankets and electric blanket.

Installation

Read Before Use

How to change the drain pipe direction

Pull out from the right side of the groove

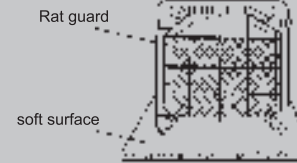

Pull out from the left side

Press the drain pipe into the groove in this place

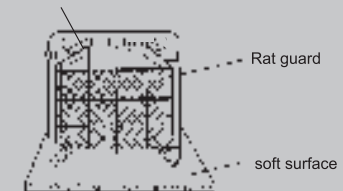

How to use drain pipe

1. The height of drain pipe should be less than 10 cm, or it may cause: drain not fluently, longer drain and stop working midway.
2. Don't trample or pressure pipes.

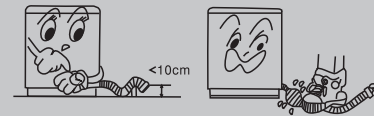

4. If you need lengthen the pipe, please purchase another pipe(which length is not exceed 1.5m) and make sealing on connected part of two pipes.

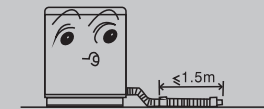

3. You can cut the drain pipe from the middle part if the pipe is too long and bevel cut the front side of the pipe can help drain fluently.



5. when pipe is too long please cut it from A or B

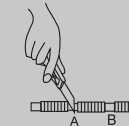

Further adjustments

Read Before Use

Connect water pipe with the washing machine

1. Don't remove the sealing ring, and please check whether the sealing ring is off or damaged before every use.
2. Input pipes connect to the valve
3. Tighten the pipe nut and shake it to check whether it is suitable

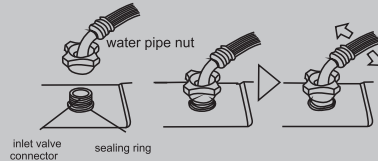

Connect pipe connector and water pipe

1. Press the slider to insert the pipe into the connector.
2. Hook the lock lever on the connector, put the slider down until hear a crack click.

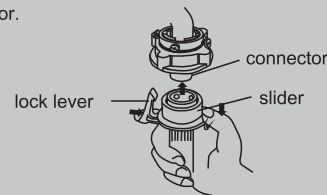

Check the connection between water pipe and tap

1. Pull water pipe slightly to check whether it is tight.
2. Turn on the tap to check whether it is leaking.
3. Don't bend the water pipe
4. Please check the connection between water pipe and tap, to check whether the installation is tight or not before use.

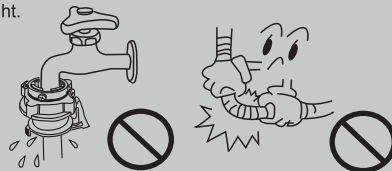

Dismantle the water pipe

1. Turn off the tap
 2. Press on the lock lever and slider then pull down the pipe.
- Tips: if use machine more than once a week, it is better to keep the pipe connector on

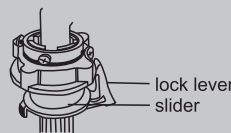

Further adjustments

Read Before Use

Check the tap

Suitable tap

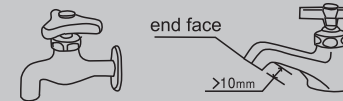

unsuitable tap

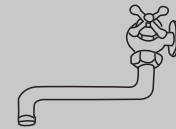

The length of the front part is required more than 10mm. Tap mouth must be even, if not, please make it even and smooth to avoid leakage.

Connect water pipe and the tap

1. Press on the bottom of lock lever and press the slider downward, take out the connector from the water pipe. See pic.1.
2. Loosen 4 screws on connector to make it can hook on the tap, input the connector on the tap. see pic.2 (if diameter of the tap is too big, please loosen the 4 screws and take off the tie-in, the tap mouth should be keep even, or it will lead to leak, see pic.3)

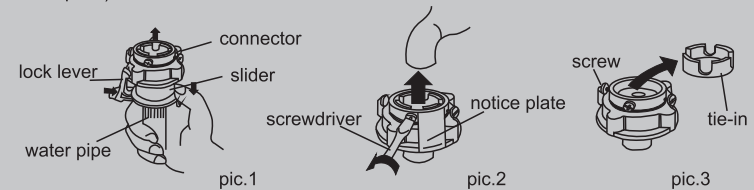

3. Tighten 4 screws as pic.4
4. Take off the notice plate and tighten the nut as pic.5

Notes: before tighten the nut, thread is about 4 mm; after tighten, it is less than 2mm.

