

USER MANUAL

**22" Self-Propelled Lawn Mower, 3-in-1
DB8605**



INTRODUCTION

Please read and follow all safety rules and instructions in this manual before attempting to operate this machine. Failure to comply with the instructions may result in personal injury. Please also read and follow all safety rules and instructions in Engine Operation Manual packed into the product packaging.

You are responsible for operating the product properly and safely.

QUESTIONS, PROBLEMS, MISSING PARTS ?

If you have any questions and need technical supports, call our customer service department at 1-800-791-9458 in Amerisun Inc, located in 351 Hastings Drive Buffalo Grove, IL60089.

CONTENTS

INTRODUCTION	1
General Operations	3
Slope Operations	4
Children	4
Safety and Instructional Decals	4
INSTALLTION INSTRUCTIONS	6
Installing Lower Handle into Housing	6
Connecting Upper Handle with Lower Handle	6
Installing Recoil-StarterRope in Rope Guide	6
Installing Grass Bag	7
Installing Side Discharge Chute	7
PRODUCT OVERVIEW	8
TECHNICAL DATA	9
OPERATION GUIDANCE	9
Filling the Engine With Oil	9
Filling the Fuel Tank	9
Adjusting the Cutting Height	10
Starting the Engine	10
Stopping the Engine	11
Using the Self-Propel Drive Bar	11
Engaging the Blade	11
Disengaging the Blade	11
Mulching the Clippings	11
Bagging the Clippings	12
Side-discharging the Clippings	12
MAINTENANCE GUIDANCE	12
Spark Plugs	12
Lubrication	12
Engine	12
Cutting Blade	13
Blade Mounting Torque	13
STORAGE GUIDANCE	14
TROUBLE SHOOTING	15
WARRANTY	16

INTRODUCTION

General Operation

- Read, understand, and follow all instructions on the machine and in the manual(s) before starting.
- Do not put hands or feet near or under the machine. Keep clear of the discharge opening at all times.
- Only allow responsible adults, who are familiar with the instructions, to operate this machine.
- Clear the area of objects such as rocks, wire, toys, etc., which could be thrown by the blade. Stay behind the handle when the engine is running.
- Be sure the area is clear of bystanders before operating. Stop machine if anyone enters the area.
- Do not operate machine barefooted or while wearing sandals. Always wear substantial footwear.
- Do not pull machine backward unless absolutely necessary. Always look down and behind before and while moving backward.
- Never direct discharged material toward anyone. Avoid discharging material against a wall or obstruction. Material may ricochet back toward the operator. Stop the blade when crossing gravel surfaces.
- Do not operate machine without the entire grass catcher, discharge guard, rear guard, or other safety protective devices in place and working.
- Never leave a running machine unattended.
- Stop the engine and wait until the blade comes to a complete stop before cleaning the machine, removing grass catcher, or unclogging the discharge guard.
- Operate machine only in daylight or good artificial light.
- Do not operate machine while under the influence of alcohol or drugs.
- Never operate mower in wet grass. Always be sure of your footing; walk; never run.
- Disengage the drive system, if so equipped, before starting the engine.
- If the machine should start to vibrate abnormally, stop the engine and check for the cause immediately. Vibration is generally a warning of trouble.
- Always wear eye protection when operating machine.
- See manufacturer's instructions for proper operation and installation of accessories. Only use accessories approved by the manufacturer.
- Never operate machine in a closed area.
- Keep all nuts and bolts tight to be sure the equipment is in safe working condition.
- If you strike a foreign object, stop and inspect the machine. Repair, if necessary, before starting.
- Never make any adjustments or repairs with the engine running. Disconnect the spark plug wire and ground against engine to prevent unintended starting.
- Check grass catcher components and the discharge guard frequently and replace with manufacturer's recommended parts when necessary.

Slope Operation

Mowing on all slopes need extra cautions, it is related to slip and fall accidents, resulting in severe injury.

- Mow across the face of slopes; never up and down. Exercise extreme caution when changing direction on slopes.
- Watch for holes, ruts, bumps, rocks, or other hidden objects. Uneven terrain could cause a slip and fall accident. Tall grass can hide obstacles.
- Do not mow on wet grass or excessively steep slopes. Poor footing could cause a slip and fall accident.
- Do no mow near drop-offs, ditches, or embankments. You could lose your footing or balance.

Children

Tragic accidents can occur if the operator is not alert to the presence of children. Children are often attracted to the machine and the mowing activity.

- Keep children out of the mowing area and under the watchful care of a responsible adult other than the operator.
- Be alert and turn mower off if a child enters the area.
- Never allow children to operate the machine.
- Use extra care when approaching blind corners, shrubs, trees, or other objects that may block your view of a child.

Safety and Instructional Decals

For your own safety please read this manual before attempting to operate your new unit. Failure to follow instructions can result in serious personal injury.



Read operator' s manual.



Keep bystanders away.



Pay attention to the operator's hands and feet to avoid injury.

Toxic fumes; Do not operate inside.



Fuel is flammable, keep away from fire. Do not add fuel with the machine running.



When mowing, please wear safety glasses and earplugs for protection.

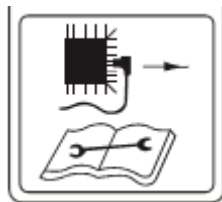

All repairs must be done according to the manual.



Caution: Engine hot

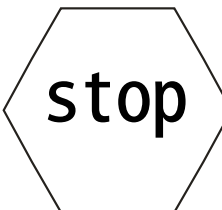

Release switch handle to stop the motor.

INSTALLATION INSTRUCTIONS

Installing Lower Handle into Housing

WARNING

- Folding or unfolding the handle improperly can damage the cables, causing an unsafe operating condition.
- Remove the bolts from the mower housing (Figure 1) .



(Figure 1)



(Figure 2)

- Move the handle to the operating position (Figure 2).
- Install and tighten the handle knobs that you removed in step a so that lower handle is installed and tightened into the mower housing (Figure 2).

Connecting the Upper Handle with the Lower Handle

- Remove the handle knobs from the Lower Handle
- Move the Upper Handle to the operating position, to install and tighten the handle knobs that you removed so that the Upper Handle and Lower Handle are installed together and tightened(Figure 3).



(Figure 3)



(Figure 4)

Installing Recoil-starter Rope in Rope Guide

- Pull the Recoil-starter Rope through the Rope Guide on the handle (Figure 4).

Installing the Grass Bag

1. Raise and hold up the Rear Deflector (Figure 5).

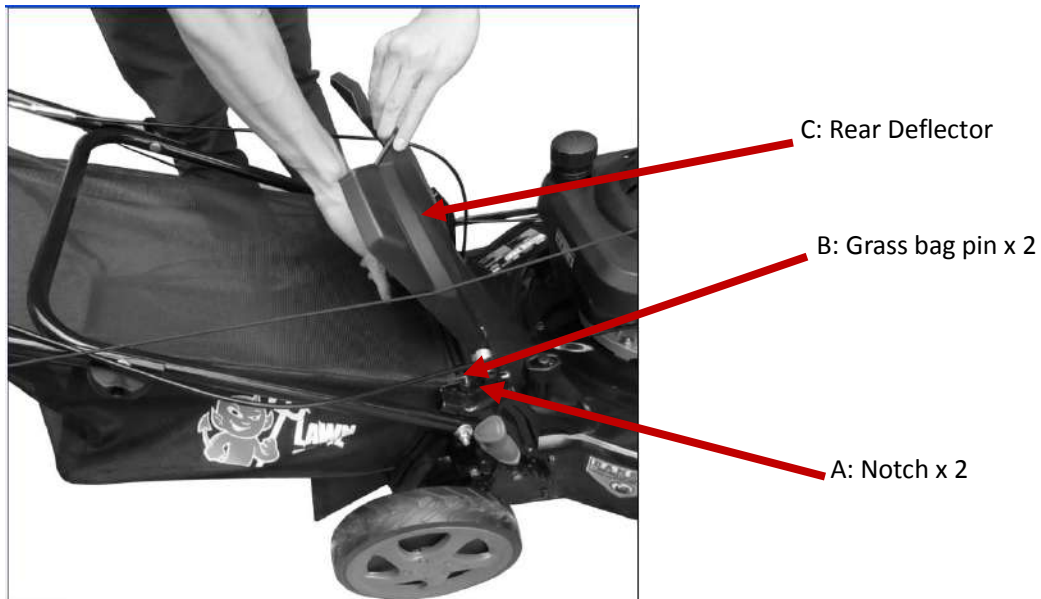

(Figure 5)

2. Install the Grass Bag, ensuring that the 2 grass bag pins rest in the Notches on the handle (Figure 5).

3. Lower the Rear Deflector.

Installing the Side Discharge Chute

Lift up the Side Deflector and install the Side Discharge Chute (Figure 6).



(Figure 6)

PRODUCT OVERVIEW

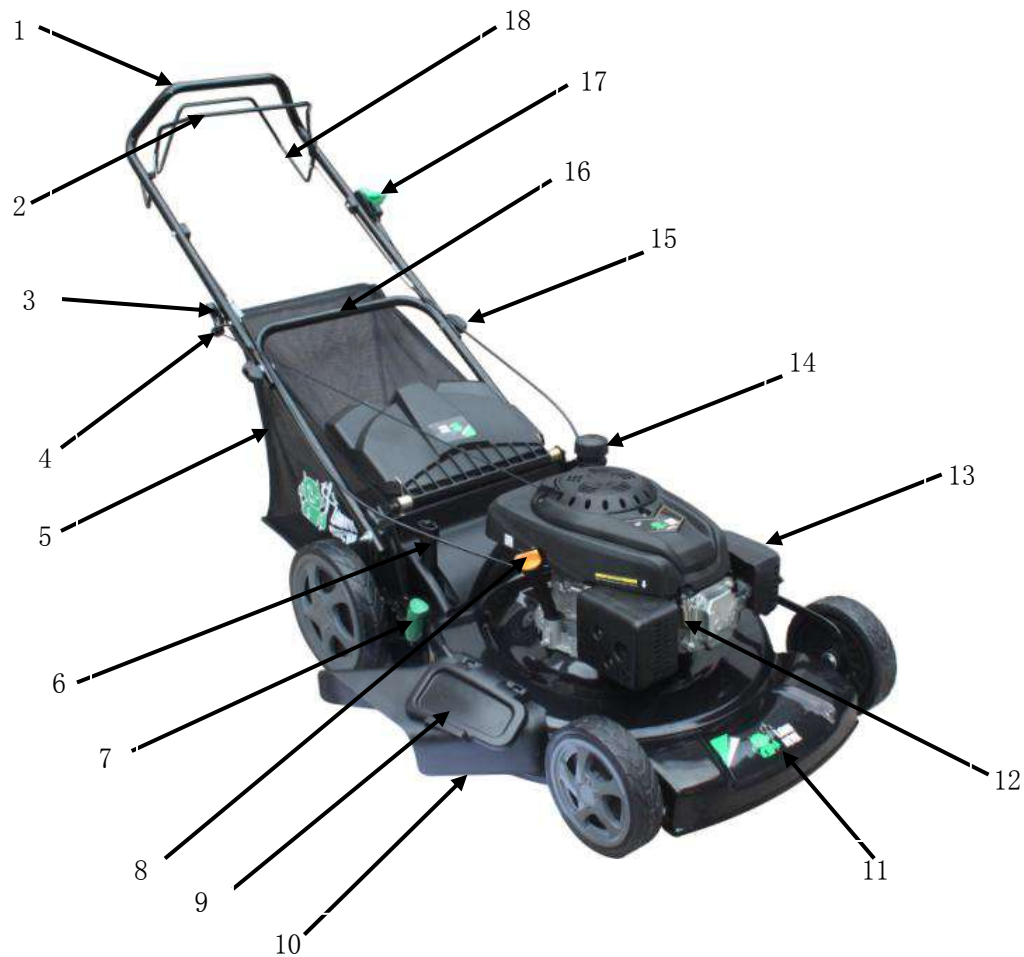

1. Upper Handle
2. Blade Control Bar
3. Recoil Starter Grip
4. Rope Guide
5. Grass Bag
6. Mulching Control Lever
7. Cutting Height Adjust Lever
8. Oil Fill/Dipstick
9. Side-discharge Deflector

10. Side-discharge Chute
11. Deck
12. Spark Plug
13. Air Filter
14. Fuel Tank Cap
15. Handle Knob x2
16. Lower Handle
17. Engine Speed Lever
18. Self-propelled Drive Bar

Technical Data

Model Number	DB8605
Engine Type	4 stroke
Engine Displacement	196cc
Discharging	Yes
Mulching	Yes
Bagging	Yes
Height Adjustment	8 positions, 1- 3-1/4 inches
Cutting Width	22" (560mm)
Front Wheel	8 inch
Rear Wheel	10 inch
Fuel Tank Capacity	0.24 Gal / 0.9L
Oil Tank Capacity	18 ounces / 0.55L
Grass Bag Capacity	15 Gal / 55L

OPERATION GUIDANCE

Filling the Engine with Oil

This engine is shipped from factory without oil. Check oil level before starting engine (Figure 7), if you start the engine without oil, the engine will be damaged beyond repair and will not be covered under warranty.

- Your mower does not come with oil in the engine. Max. fill: 18 ounces SAE 10W-30 is recommended for general use.

Please refer to Engine Manual for more details.



(Figure 7)

Filling the Fuel Tank

Gasoline is extremely flammable and explosive. A fire or explosion from gasoline can burn you and others.

- To prevent a static charge from igniting the gasoline, place the container and/or mower directly on the ground before filling, not in a vehicle or on an object.

- Fill the tank outdoors when the engine is cold. Wipe up spills.
- Do not handle gasoline when smoking or around an open flame or sparks.
- Store gasoline in an approved fuel container, out of the reach of children.

Please refer to Engine Manual for more details.

Adjusting the Cutting Height

Warning: Adjusting the cutting height may bring you into contact with the moving blade, causing serious injury.

- Adjust the height with the engine off.
- Move the height adjustment forward to lower the height, back to raise the cutting height.

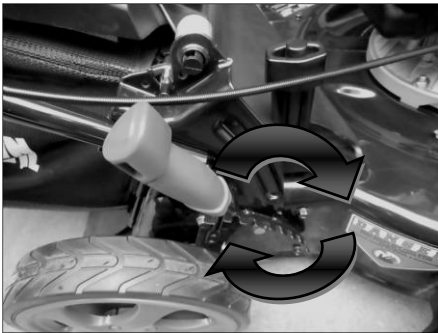

(Figure 8)

Starting the Engine

- Before starting the engine, adjust the engine speed lever to the upper start position as shown in Figure 9.
- Hold on the Upper handle and Blade-control Bar tightly with your right hand, pull the Recoil-start Grip lightly until you meet resistance, then pull briskly. Release the starter grip gently after the engine starts, as shown in figure 10.

- Adjust the Engine Speed Lever to suitable speed for mowing. (Figure 11)



(Figure 9)



(Figure 10)

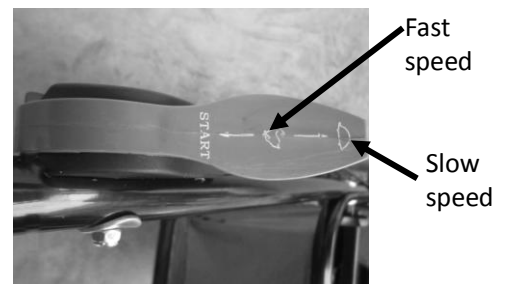

(Figure 11)

Stopping the Engine

When you release the Blade-Control Bar, the blade should stop within 3 seconds. If it does not stop properly, stop using your machine immediately and contact our customer service department at 1-800-791-9458.

Using the Self-propelled Drive Bar

Pull the lower Self-propelled Drive Bar to the handle. (Figure 12).



(Figure 12)



(Figure 13)

Engaging the Blade

When starting engine, the blade will not turn. You must engage the blade to mow. Pull the Blade Control Bar to the handle, hold the Blade Control Bar against the handle (Figure 13).

Disengaging the Blade

Release the Blade Control Bar (Figure 14).

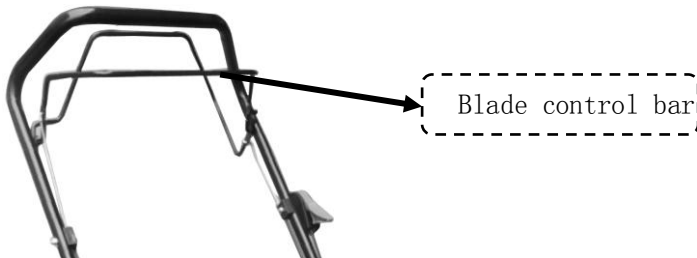

(Figure 14).

Important: When you release the Blade Control Bar, the blade should stop within 3 seconds. If it does not stop properly, stop using your mower immediately and contact our customer service department at 1-800-791-9458.

Mulching the Clippings

If the Grass Bag is on the mower, and the Mulching Control Lever is in the bagging position, move the lever to the mulching position before mulching the clippings.

If the Side-discharge Chute is on the mower, remove it before mulching the clippings.

Bagging the Clippings

Use Grass Bag to collect grass and leaf clippings from the lawn. If the Side Discharge Chute is on the mower, remove it before bagging the clippings. If the Mulching Control Lever is in mulching position, move it to the bagging position.

WARNING

A Grass Bag could allow small stones and other similar debris to be thrown in the operator's or bystander's direction and result in serious personal injury or death to the operator or bystanders. Check the Grass Bag frequently.

Side-discharging the Clippings

Use the Side Discharge for cutting very tall grass. If the Grass Bag is on the mower and the Mulching Control Lever is in the bagging position, move the lever to the mulching position.

WARNING

The blade is sharp; contacting the blade can result in serious personal injury. Stop the engine and wait for all moving parts to stop before leaving the operating position.

MAINTENANCE GUIDANCE

Spark Plug

Use only original replacement spark plug. For best results, replace the spark plug every 100 hours of use. (refer to The Engine Manual)

Lubrication Instructions

CAUTION: Disconnect Spark Plug Before Servicing.

- **WHEELS:** Lubricate the ball bearings at least once a season with a light oil.
- **ENGINE:** Follow The Engine Manual for lubrication instructions.
- **BLADE CONTROL:** Lubricate the pivot points on the blade control handle and the brake cable at least once a season with light oil or WD-40. The blade control must operate freely in both directions.

Engine

Refer to the separate Engine Manual for engine maintenance instructions.

Clean the engine regularly with a cloth or brush. Keep the cooling system (blower housing area) clean to permit proper air circulation which is essential to engine performance and life. Be certain to remove all grass, dirt and combustible debris

from muffler area. Do not hose engine. Water can damage engine or contaminate the fuel system.

CAUTION:

Do not allow dirt or dust to clog the air filter foam element. The engine air cleaner element must be serviced (cleaned) after 25 hours normal mowing. The foam element must be serviced regularly if the mower is used in dry dusty conditions.

Replace air filter if frayed, torn, damaged or unable to be cleaned.

Clean the air filter with warm soapy water. You can use a liquid dish soap to clean the air filter.

Cutting Blade

CAUTION:

Be sure to disconnect and ground the spark plug wire before working on the cutting blade to prevent accidental engine starting. Protect hands by using heavy gloves or a rag to grasp the cutting blades.

Remove the hex bolt and washer which hold the blade and blade adapter to the engine crankshaft. Remove the blade and adapter from the crankshaft.

WARNING: Periodically inspect the blade adapter for cracks, especially if you strike a foreign object. Replace when necessary.

For best results, your blade should be sharp. The blade may be re-sharpened by removing it from the machine and either grinding or filing the cutting edge keeping as close to the original bevel as possible.

It is extremely important that each cutting edge receives an equal amount of grinding to prevent an unbalanced blade.

Improper blade balance will result in excessive vibration causing eventual damage to the engine and mower. Be sure to carefully balance blade after sharpening. The blade can be tested for balance by balancing it on a round shaft screwdriver.

Before reassembling the blade and the blade adapter to the unit, lubricate the engine crankshaft and the inner surface of the blade adapter with light oil. Install the blade adapter on the crankshaft.

Place the blade with the part number facing away from the adapter. Align the washer over the blade and insert the hex bolt. Tighten the hex bolt to the torque listed below.

Blade Mounting Torque

Center Bolt must be tightened to 35 - 42 Nm torque. To ensure safe operation of

your unit, all nuts and bolts must be checked periodically for correct tightness. After prolonged use, especially in sandy soil conditions, the blade will become worn and lose some of the original shape. Cutting efficiently will be reduced and the blade should be replaced.

Replace with an approved factory replacement blade only. Possible damage resulting from blade an unbalanced condition is not the responsibility of the manufacturer. Please contact our customer service department at 1-800-791-9458 to order approved a factory replacement blade.

WARNING: Do not touch rotating blade.

STORAGE INSTRUCTIONS

The following steps should be taken to prepare lawn mower for storage.

- Following the final cut of the season allow the fuel tank to run dry.
- Clean and lubricate mower thoroughly as described in the lubrication instructions. Disconnect the spark plug cap.
- Refer to engine manual for correct engine storage instructions.
- Lightly coat mower's cutting blade with chassis grease to prevent rusting.
- Store mower in a dry, clean area.
- Lubricate cables with WD-40

NOTE:

- When storing any type of power equipment in an unventilated area. Care should be taken to rust-proof the equipment. Using a light oil or silicone, coat the equipment, especially cables and all moving parts.
- Be careful not to bend or kink cables.
- If the starter rope becomes disconnected from rope guide on handle, disconnect and ground the spark plug wire, Depress the blade control handle and pull the starter rope out from engine slowly. Slip the starter rope into the rope guide bolt on the handle.

ENVIRONMENT

Should your machine need replacement after extended use, do not put it in the domestic waste but dispose of it in an environmentally safe way.

Trouble Shooting

PROBLEM	PROBABLE CAUSE	CORRECTIVE ACTION
Engine does not start.	Throttle lever not in the correct position for the prevailing conditions.	Move throttle lever to correct position.
	Fuel tank is empty.	Fill tank with fuel: refer to the ENGINE MANUAL.
	Air cleaner element is dirty.	Clean air cleaner element: refer to the ENGINE MANUAL.
	Spark plug is loose.	Tighten spark plug to 25-30Nm.
	Spark plug wire loose or disconnected from plug.	Install spark plug wire on spark plug.
	Spark plug gap is incorrect	Set gap between electrodes at 0.7 to 0.8mm.
	Spark plug is defective..	Install new, correctly gapped plug: refer to the ENGINE MANUAL.
	Faulty ignition module	Contact authorized service centre.
Engine difficult to start or loses power.	Dirt, water, or stale fuel tank.	Drain fuel and clean tank. Fill tank with clean, fresh fuel.
	Vent hole in fuel tank cap is plugged.	Clean or replace fuel tank cap.
	Air cleaner element is dirty.	Clean air cleaner element.
Engine operates erratically.	Spark plug is defective.	Install new, correctly gapped plug: refer to the ENGINE MANUAL.
	Spark plug gap is incorrect.	Set gap between electrodes at 0.7 to 0.8.
	Air cleaner element is dirty.	Clean air cleaner element
Engine idles poorly.	Air cleaner element is dirty.	Clean air cleaner element
	Air vents in engine shield are blocked.	Remove debris from air vents.
Engine idles poorly.	Cooling fan and air passages under engine blower housing are blocked.	Remove debris from cooling fans and air passages.
Engine skips at high speed.	Gap between electrodes of spark is too close.	Set gap between electrodes at 0.7 to 0.8.
Engine overheats.	Cooling air flow is restricted.	Remove any debris from slots in shield, blower housing, air passages.
	Incorrect spark plug.	Install correct spark plug and clear cooling fins on engine.
Mower vibrates abnormally.	Cutting assembly is loose.	Tighten blade.
	Cutting assembly is unbalanced.	Balance blade.

TWO YEAR WARRANTY

Amerisun Inc. and LCT Engine Corporation jointly warrant this product for two years against defects in material or workmanship when used for normal residential purposes. The manufacturer will, at its option, repair or replace, for the original purchaser, any part or parts which have been found to be defective in material and workmanship. Residential use means use of the product on the same lot as your home.

- If you have questions or problems, or before returning this product, call toll-free 1-800-791-9458 or email support@amerisuninc.com

This warranty covers product defects only. Neither Amerisun nor LCT Engine Corporation is liable for indirect, incidental, or consequential damages in connection with the use of PowerSmart Products covered by this warranty, including any cost or expense of providing substitute equipment or service during reasonable periods of mal-function or non-use pending completion of repairs under this warranty. Transportation to and from the services center is the responsibility of the consumer. Some states do not allow exclusions of incidental or consequential damages, so the above exclusions may not apply to you. This warranty gives you specific legal rights, and you may also have other rights which vary from state to state.

DISCLAIMER

The information contained within this manual is the latest information as of the publication date. All content and images are subject to change without notice. This manual is intended as a guide. This manual is intended as a guide. For the latest information and procedures visit amerisuninc.com.