



Deluxe Wireless Speaker

PBT3032 User Manual



Questions?
Need some help?
This manual will help you
enjoy your new product



Visit us at:
SouthernTelecom.com
Click on Product Support

In the Box

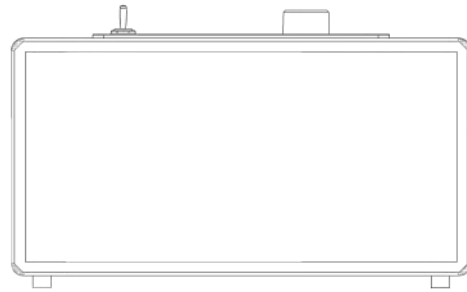

Wireless Speaker

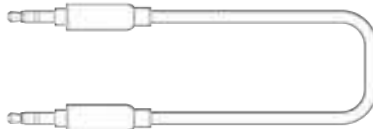

3.5mm Auxiliary
Cable

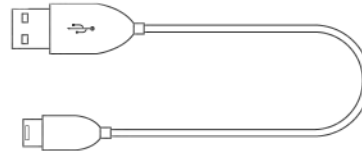

Micro-USB
Charging Cable

Location of Controls

1. [POWER] Switch
2. Charging LED Indicator
3. Bluetooth LED Indicator
4. Volume Knob
5. 3.5mm Auxiliary Input Jack

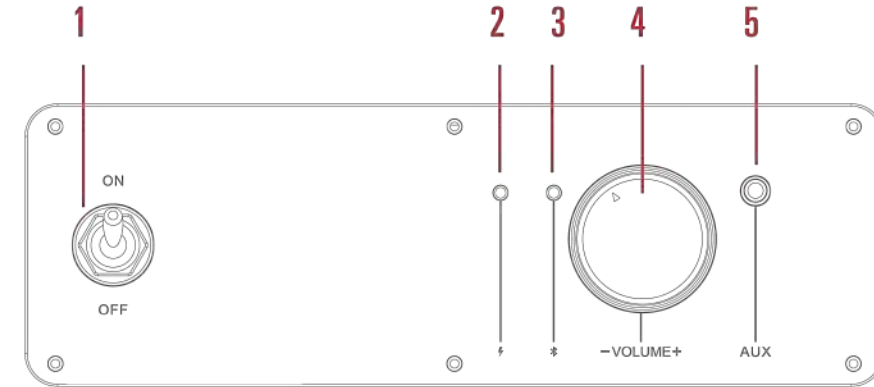

Pairing the Speaker

1. Turn the speaker ON by moving the [POWER] switch to the ON position. A tone will be heard indicating the speaker has power and the Bluetooth LED indicator will **quickly flash BLUE**.
2. Set your mobile device to search for Bluetooth devices. When it appears, select **PBT3032** from the list of found devices.
3. Once successfully paired, a tone will be heard and the Bluetooth LED indicator will **slowly flash BLUE**.



For iOS or Android

- Go to **SETTINGS > BLUETOOTH**
(Make sure Bluetooth is turned ON)



The screenshots above are typical of many Bluetooth-enabled devices in the market today and are used to assist in the explanation of the pairing process. Your Bluetooth-enabled device's user manual/instruction with the speaker may differ slightly from the illustrations above.

Using the Speaker



Be sure to charge the speaker for 3-5 hours before using for the first time.

Powering ON/OFF

- Flip the [POWER] switch to the ON position to turn the speaker ON.
- Flip the [POWER] switch to the OFF position to turn the speaker OFF.

Volume Adjustment

- Turn the Volume knob on the top panel to adjust volume.

Using the Speaker (cont'd)

Playing Music

To enjoy music wirelessly on your speaker, make sure you are paired to a Bluetooth-enabled device. Once paired, you can control media playback on your paired device, and can adjust volume on the speaker or with your paired device.

If you are pairing the device for the first time, please consult the **Pairing the Speaker** part of this user guide.

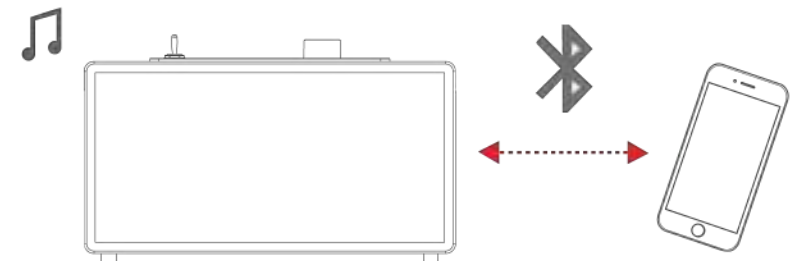

Charging the Speaker

Attach the small connector of the supplied micro-USB charging cable to the DC 5V charging port on the back of the speaker. Attach the large connector to the USB port on a computer, a USB charging device, or a **5V USB adapter** (not included) and plug into a wall socket.

The charging LED indicator will turn **RED** while charging and will turn off when fully charged.

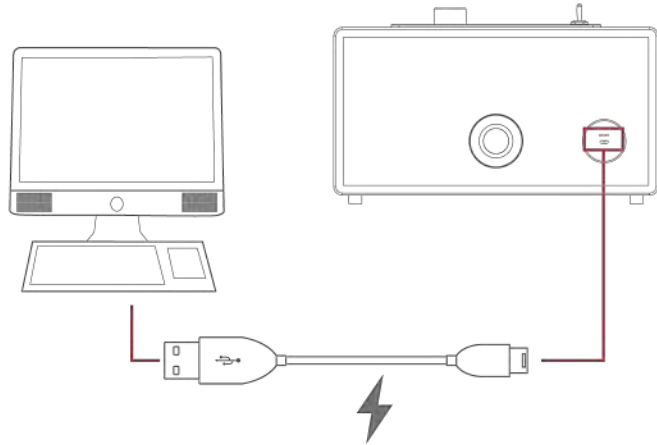

Using the Auxiliary Input

Attach one connector of the supplied 3.5mm auxiliary cable to the input jack. Attach the other connector to the headphone jack on your media-playing device. Once plugged in, the speaker will automatically switch to auxiliary input mode. Media playback is controlled through your connected device.

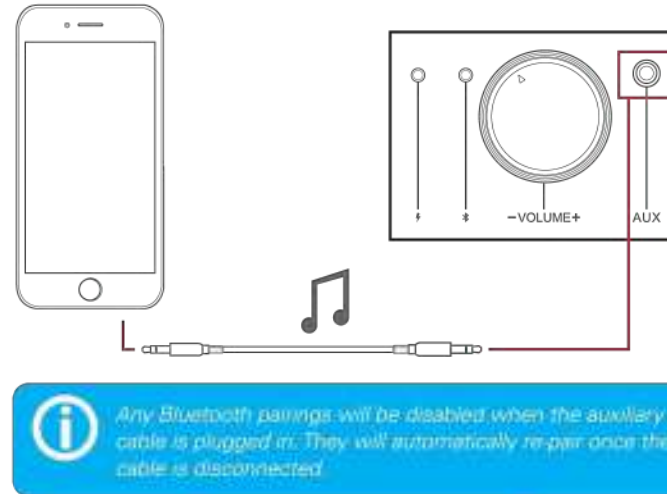

Legal Information

READ THIS CAREFULLY AND SAVE FOR FUTURE REFERENCE

This equipment has been tested and found to comply with the limits for a Class B digital device, pursuant to part 15 of the FCC Rules. These limits are designed to provide reasonable protection against harmful interference in a residential installation. This equipment generates, uses and can radiate radio frequency energy and, if not installed and used in accordance with the instructions, may cause harmful interference to radio or television reception, which can be determined by turning the equipment off and on, the user is encouraged to try to correct the interference by one or more of the following measures:

- Reorient or relocate the receiving antenna.
- Increase the separation between the equipment and receiver.
- Connect the equipment into an outlet on a circuit different from that to which the receiver is connected.
- Consult the dealer or an experienced radio/TV technician for help.

Caution: Any changes or modifications to this device not explicitly approved by manufacturer could void your authority to operate this equipment.

This device complies with part 15 of the FCC Rules. Operation is subject to the following two conditions: (1) This device may not cause harmful interference, and (2) this device must accept any interference received, including interference that may cause undesired operation.

The device has been evaluated to meet general RF exposure requirement. The device can be used in portable exposure condition without restriction.

Legal Information (cont'd)

WARNING Li-ion Battery Inside

This product is fitted with a Li-ion battery. Do not damage, open, or dismantle the battery and do not use it in damp and/or corrosive conditions. Use only with compatible chargers. Never dispose of batteries in a fire, and never expose them to high temperatures. Do not expose the product to temperatures exceeding 60°C (140°F).



The crossed-out garbage bin symbol means that you must not dispose of this product together with unsorted household waste.

Rain/Moisture Warning

- Do not expose the unit to extreme temperatures (heat or cold), open flames, humid conditions, or wet conditions.
- Do not submerge in water.
- Do not open this product or attempt to repair the unit yourself should it not be working.

Warranty Information

This product as supplied and distributed new by AIT, Inc. ("AIT") to the original consumer purchaser is warranted by AIT against defects in material and workmanship for a period of one year from your date of purchase ("Warranty"). In the unlikely event that this product is defective, or does not perform properly, you may within one year from your original date of purchase return it to the authorized service center for repair or exchange.

TO OBTAIN WARRANTY SERVICE:

- Go to our website portal to receive an SRO number.
- Provide proof of the date of purchase within the package (dated bill of sale).
- Prepay all shipping costs to the authorized service center, and remember to insure your return.
- Include a return shipping address (no P.O. Boxes), a telephone contact number, and the defective unit within the package.
- Describe the defect or reason you are returning the product.

Your product will be repaired or replaced, at our option, for the same or similar model of equal value if examination by the service center determines this product is defective. Products received damaged as a result of shipping, will require you to file a claim with the carrier.

The shipping address of the authorized service center is:

AIT, Inc.
Customer Service Dept. 36
c/o Southern Telecom
400 Kennedy Drive
Sayreville, NJ 08872

For further customer service:

 **SouthernTelecom.com**
Click on **Product Support**

IN NO EVENT WILL AIT, ITS MANUFACTURERS, DISTRIBUTORS OR PLR IP HOLDINGS, LLC BE LIABLE FOR ANY INCIDENTAL, DIRECT, INDIRECT, SPECIAL, PUNITIVE OR CONSEQUENTIAL DAMAGES (SUCH AS, BUT NOT LIMITED TO, DAMAGES FOR LOSS OF PROFITS, BUSINESS, SAVINGS, DATA OR RECORDS) RELATED TO THIS PRODUCT. EXCEPT AS STATED HEREIN, NO OTHER WARRANTIES SHALL APPLY.



PLR IP Holdings, LLC, its licensees and affiliates, fully support all electronic waste initiatives. As responsible stewards of the environment, and to avoid violating established laws, you should properly dispose of this product in compliance with all applicable regulations, directives or other governances in the area where you reside. Please check with local authorities or the retailer where you purchased this product to determine a location where you can appropriately dispose of the product.

Polaroid, Polaroid & Pixel, Polaroid Color Spectrum, and Polaroid Classic Border Logo are trademarks of PLR, IP Holdings, LLC, used under license.

