



## **Presence Switch H2 US – User Manual**

For

Presence Switch H2 US (2 Buttons, 1 Channel)

Presence Switch H2 US (2 Buttons, 2 Channels)

Presence Switch H2 US (4 Buttons, 3 Channels)

## Product Introduction

Aqara Presence Switch H2 US is a smart switch based on Thread/Zigbee wireless communication protocols which can control lights, automations, and scenes. When used with a hub, it can be controlled via the app, and has features for scheduling, power monitoring, power statistics, and other functions. It can also be used with other smart devices to enable a variety of interconnected control functions.

\*This product needs to be used with a device that has Matter Border Router function.

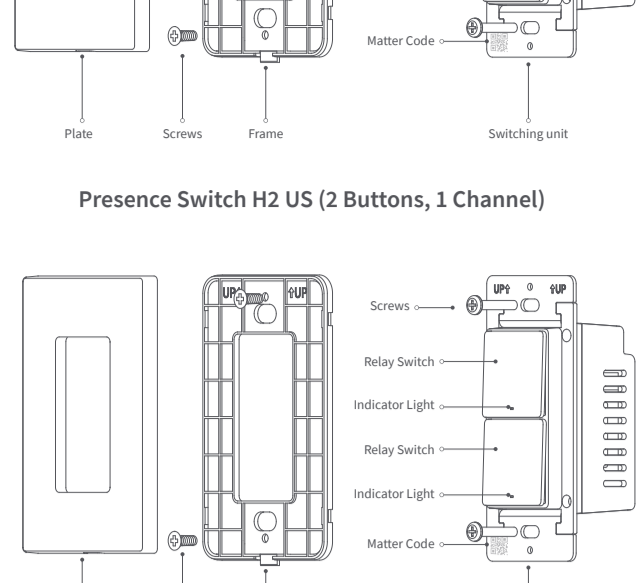

### Presence Switch H2 US (2 Buttons, 1 Channel)

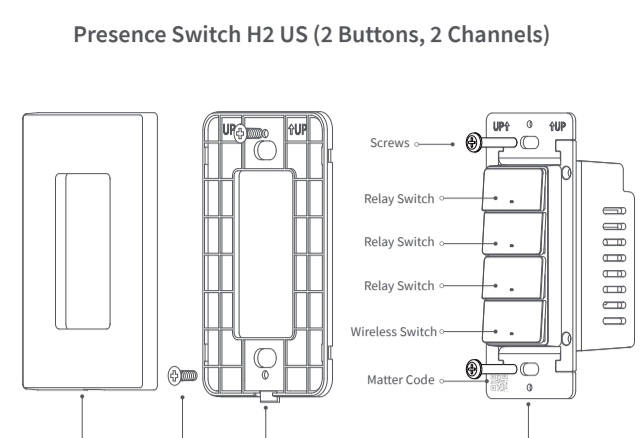

### Presence Switch H2 US (2 Buttons, 2 Channels)

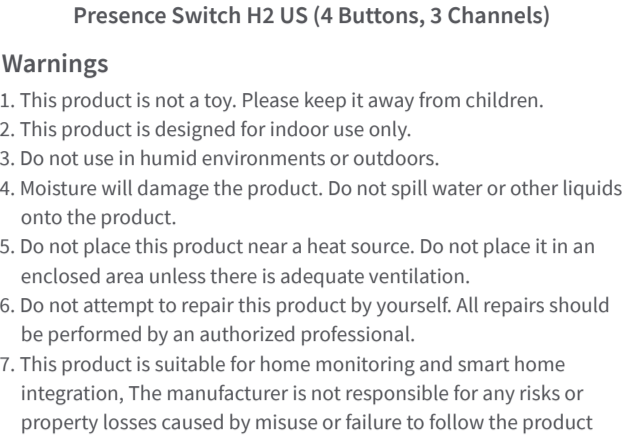

### Presence Switch H2 US (4 Buttons, 3 Channels)

## Warnings

1. This product is not a toy. Please keep it away from children.
2. This product is designed for indoor use only.
3. Do not use in humid environments or outdoors.
4. Moisture will damage the product. Do not spill water or other liquids onto the product.
5. Do not place this product near a heat source. Do not place it in an enclosed area unless there is adequate ventilation.
6. Do not attempt to repair this product by yourself. All repairs should be performed by an authorized professional.
7. This product is suitable for home monitoring and smart home integration. The manufacturer is not responsible for any risks or property losses caused by misuse or failure to follow the product instructions.

## Installation Method

### Presence Switch H2 US (2 Buttons, 1 Channel)

1. Please make sure that the power at circuit breaker or fuse box is turned off before wiring!

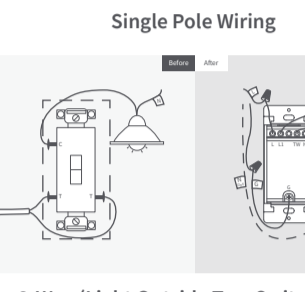

2. Identify the type of electrical circuit in your home. For the 2 button and 1 channel switch, we support three types of circuits:
  - a) single pole
  - b) 3-way (light outside two switches)
  - c) 3-way (light between two switches)
 Please follow the instructions below to determine your home's circuit type and wire it correctly. For 3-way circuit wiring, we recommend seeking assistance from a professional electrician.

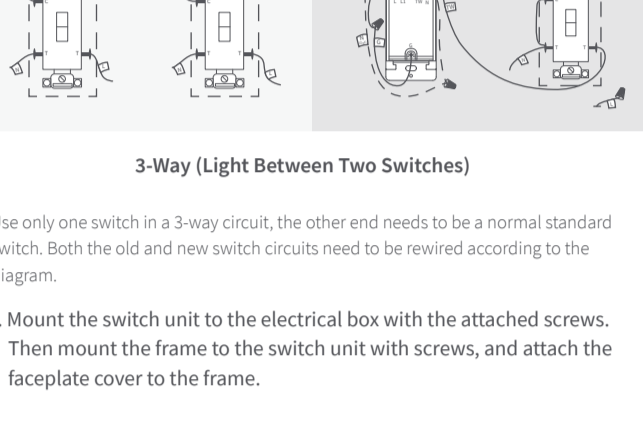

#### Single Pole Wiring

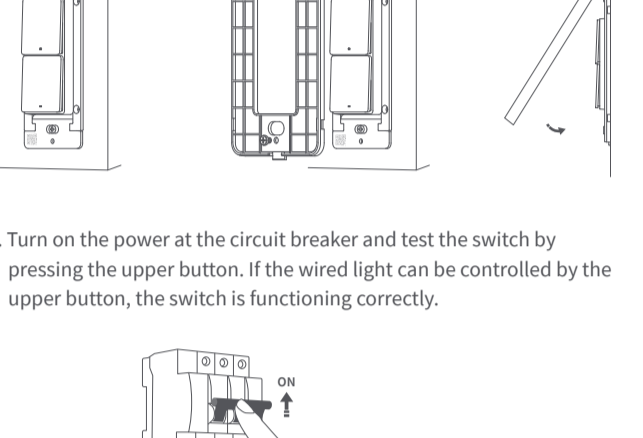

#### 3-Way (Light Outside Two Switches)

\* Use only one switch in a 3-way circuit, the other end needs to be a normal standard switch. Both the old and new switch circuits need to be rewired according to the diagram.

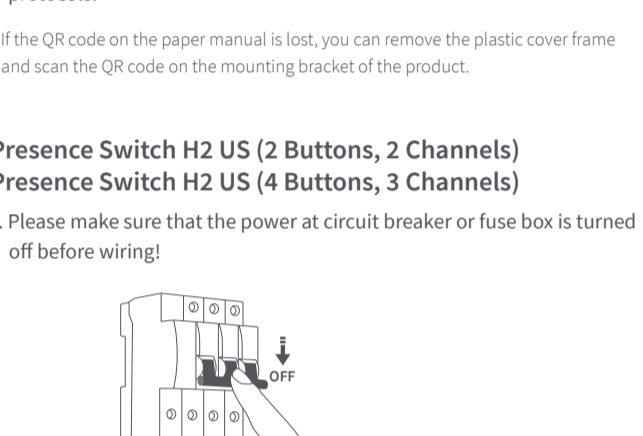

#### 3-Way (Light Between Two Switches)

\* Use only one switch in a 3-way circuit, the other end needs to be a normal standard switch. Both the old and new switch circuits need to be rewired according to the diagram.

3. Mount the switch unit to the electrical box with the attached screws. Then mount the frame to the switch unit with screws, and attach the faceplate cover to the frame.

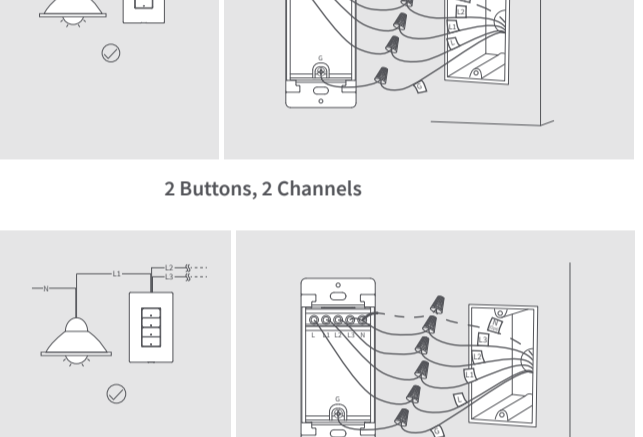

4. Turn on the power at the circuit breaker and test the switch by pressing the upper button. If the wired light can be controlled by the upper button, the switch is functioning correctly.

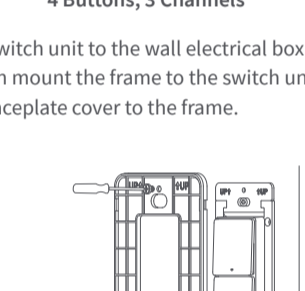

5. In the Aqara Home app, tap Add Accessory, choose Presence Switch H2 US. Scan the Matter QR Code on the paper manual to add the device to the app. The following Quick Setup section will introduce the network configuration methods for both Zigbee and Thread protocols.

\* If the QR code on the paper manual is lost, you can remove the plastic cover frame and scan the QR code on the mounting bracket of the product.

### Presence Switch H2 US (2 Buttons, 2 Channels)

### Presence Switch H2 US (4 Buttons, 3 Channels)

1. Please make sure that the power at circuit breaker or fuse box is turned off before wiring!

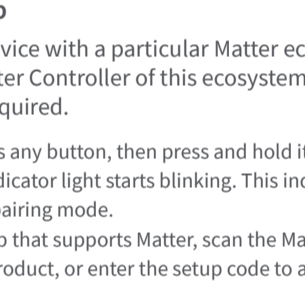

2. For users with Presence Switch H2 US (2 Buttons, 2 Channels) or (4 Buttons, 3 Channels), please follow the corresponding wiring methods according to your product model. It is recommended to seek assistance from a professional electrician to complete this step.

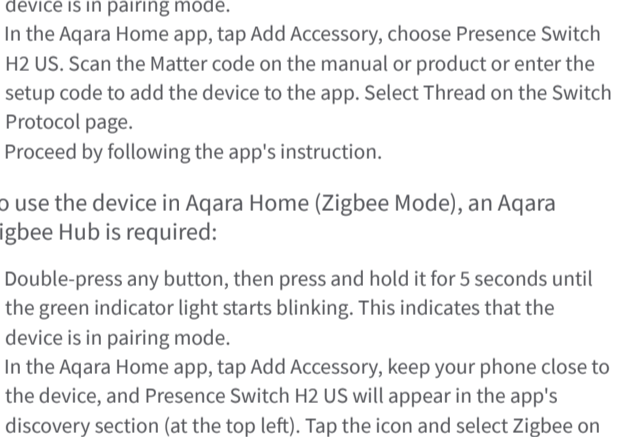

#### 2 Buttons, 2 Channels

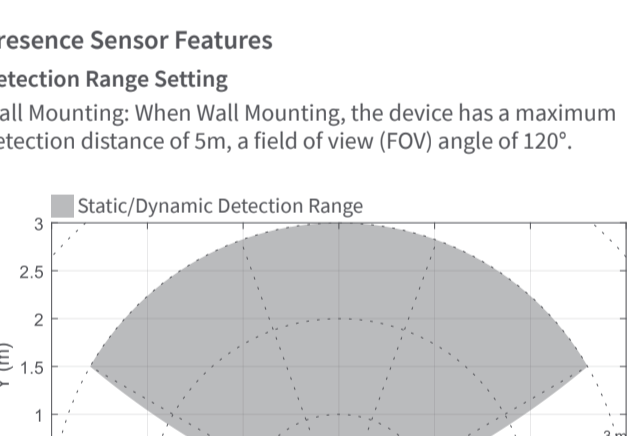

#### 4 Buttons, 3 Channels

3. Mount the switch unit to the wall electrical box with the attached screws. Then mount the frame to the switch unit with screws, and attach the faceplate cover to the frame.

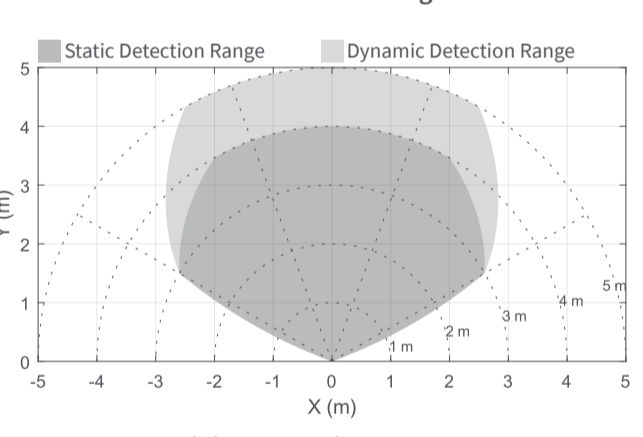

4. Turn on the power at the circuit breaker and test the switch by pressing the upper button. If the wired light can be controlled by the upper button, the switch is functioning correctly.

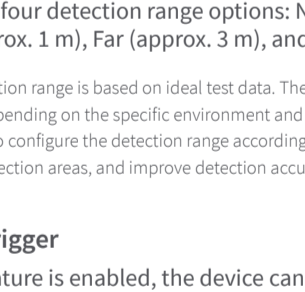

5. In the Aqara Home app, tap Add Accessory, choose Presence Switch H2 US. Scan the Matter QR Code on the paper manual to add the device to the app. The following Quick Setup section will introduce the network configuration methods for both Zigbee and Thread protocols.

\* If the QR code on the paper manual is lost, you can open the product cover and scan the QR code on the metal frame of the product.

## Quick Setup

To use the device with a particular Matter ecosystem (Thread Mode), a Matter Controller of this ecosystem and a Thread Border Router are required.

1. Double-press any button, then press and hold it for 5 seconds until the green indicator light starts blinking. This indicates that the device is in pairing mode.
2. Open the app that supports Matter, scan the Matter code on the manual or product, or enter the setup code to add the device to the app.
3. Proceed following the app's instruction.

To use the device in Aqara Home (Thread Mode), an Aqara Hub with border router function (for example, Hub M3) is required:

1. Double-press any button, then press and hold it for 5 seconds until the green indicator light starts blinking. This indicates that the device is in pairing mode.
2. In the Aqara Home app, tap Add Accessory, choose Presence Switch H2 US. Scan the Matter code on the manual or product or enter the setup code to add the device to the app. Select Thread on the Switch Protocol page.
3. Proceed by following the app's instruction.

To use the device in Aqara Home (Zigbee Mode), an Aqara Zigbee Hub is required:

1. Double-press any button, then press and hold it for 5 seconds until the green indicator light starts blinking. This indicates that the device is in pairing mode.
2. In the Aqara Home app, tap Add Accessory, keep your phone close to the device, and Presence Switch H2 US will appear in the app's discovery section (at the top left). Tap the icon and select Zigbee on the Switch Protocol page.
3. Proceed by following the app's instruction.

## Presence Sensor Features

### Detection Range Setting

Wall Mounting: When Wall Mounting, the device has a maximum detection distance of 5m, a field of view (FOV) angle of 120°.

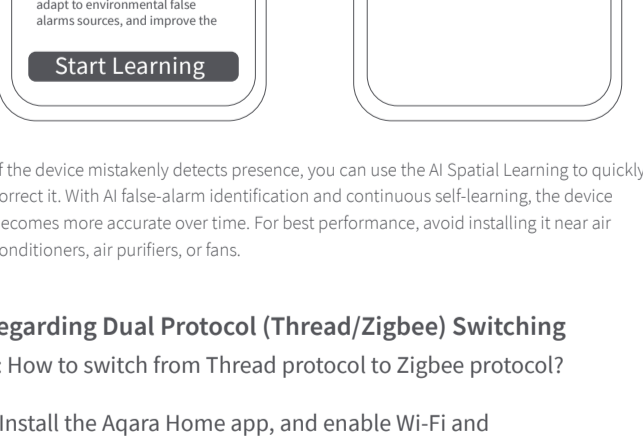

### Matter Detection Range

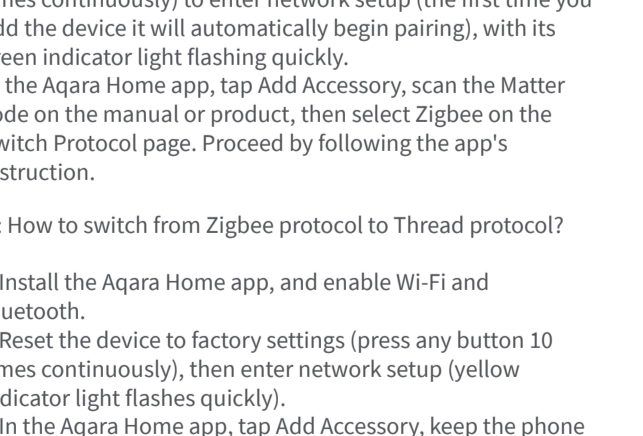

### Zigbee Detection Range

In Matter mode, the device's default maximum detection range is 3m. In Zigbee mode, the device's default maximum detection range is 5m and supports four detection range options: Near (approx. 0.5 m), Medium (approx. 1 m), Far (approx. 3 m), and Farthest (approx. 5 m).

\* The above detection range is based on ideal test data. The actual detection range during use may vary depending on the specific environment and conditions. It is recommended to configure the detection range according to actual needs, exclude unnecessary detection areas, and improve detection accuracy.

## Presence Trigger

When this feature is enabled, the device can automate lights to turn on when presence is detected, turn off when absence is detected. Each switch button can be configured individually for flexible control.

\* To improve user experience, the device has a built-in default absence delay of 10 seconds. Even if no turn off absence delay is configured, the device will still wait 10 seconds before turning off. This helps prevent false triggers caused by brief absence or slight movement.

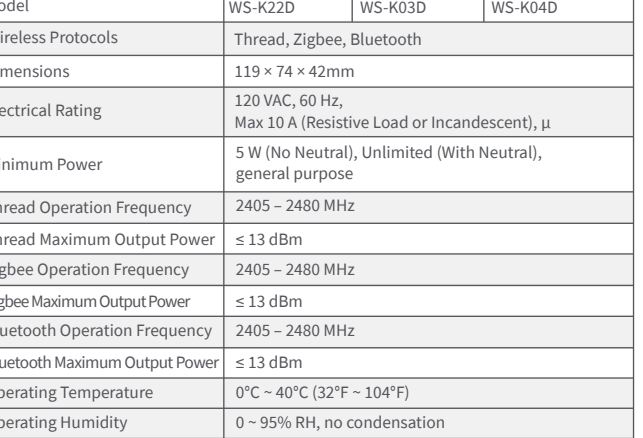

The same functionality can also be achieved through the following automation: If "Presence", then "turn on the light"; If "Absence for a certain period of time", then "turn off the lights or the air conditioning".

## AI Spatial Learning

AI spatial learning can intelligently learn the environmental background, eliminate the false alarms of large areas of glass, metal, mirrors, etc. on the detection results, intelligently adapt to environmental false alarms sources, and improve the accuracy of detection results.

It is recommended that users actively conduct AI spatial learning after the device is installed. AI spatial learning requires that the space be unoccupied and takes about 30 seconds. Please wait patiently.

During use, the device will continue to learn the spatial background through AI to adapt to the real-time changing spatial environment, making the device more accurate with use.

If, under special circumstances, the user finds that the device mistakenly reports a false presence status when the space should be absent, an AI spatial learning can be performed immediately to quickly restore the space to an empty state.



\* If the device mistakenly detects presence, you can use the AI Spatial Learning to quickly correct it. With AI false-alarm identification and continuous self-learning, the device becomes more accurate over time. For best performance, avoid installing it near air conditioners, air purifiers, or fans.

## Regarding Dual Protocol (Thread/Zigbee) Switching

Q: How to switch from Thread protocol to Zigbee protocol?

A:

1. Install the Aqara Home app, and enable Wi-Fi and Bluetooth.
2. Reset the device to factory settings (press any button 10 times continuously) to enter network setup (the first time you add the device it will automatically begin pairing), with its green indicator light flashing quickly.

In the Aqara Home app, tap Add Accessory, scan the Matter code on the manual or product, then select Zigbee on the Switch Protocol page. Proceed by following the app's instruction.

Q: How to switch from Zigbee protocol to Thread protocol?

A:

1. Install the Aqara Home app, and enable Wi-Fi and Bluetooth.
2. Reset the device to factory settings (press any button 10 times continuously), then enter network setup (yellow indicator light flashes quickly).

In the Aqara Home app, tap Add Accessory, keep the phone close to the device, and the Presence Switch H2 US will show in the app's discovery section (at the top left). Tap the icon and select Thread in the Switch Protocol page. Proceed by following the app's instruction.

## Indicator Light Description

Indicator light status	Description
Green indicator light quickly flashes 3 times	Device powered on
Green indicator light flashes quickly	Pairing/Seeking Device (Thread protocol)
Green indicator light stays on for 1s	Pairing successful
Red indicator light stays on	Pairing timeout
Red indicator light flashes slowly 3 times	Device voltage is unstable, please connect to a higher power load
Yellow indicator light flashes quickly	Seeking device (Zigbee protocol)

## Button Description

Single press once	Turn On/Off
Double press, then press and hold for 5 seconds within 3 seconds	Reset the Device/Enable Pairing
Press any button 10 times continuously	Reset to factory settings
Single-Press Mode: Single Press Multi-Function Mode: Single Press, Double Press, Long Press	Configure and define these Wireless Switch Mode actions under Automation in Aqara Home (Zigbee Mode)

## Product Specifications

Product Name	Presence Switch H2 US (2 Buttons, 1 Channel)	Presence Switch H2 US (2 Buttons, 2 Channels)	Presence Switch H2 US (4 Buttons, 3 Channels)
Model	WS-K22D	WS-K03D	WS-K04D
Wireless Protocols	Thread, Zigbee, Bluetooth		
Dimensions	119 × 74 × 42mm		
Electrical Rating	120 VAC, 60 Hz, Max 10 A (Resistive Load or Incandescent), $\mu$		
Minimum Power	5 W (No Neutral), Unlimited (With Neutral), general purpose		
Thread Operation Frequency	2405 ~ 2480 MHz		
Thread Maximum Output Power	≤ 13 dBm		
Zigbee Operation Frequency	2405 ~ 2480 MHz		
Zigbee Maximum Output Power	≤ 13 dBm		
Bluetooth Operation Frequency	2405 ~ 2480 MHz		
Bluetooth Maximum Output Power	≤ 13 dBm		
Operating Temperature	0°C ~ 40°C (32°F ~ 104°F)		
Operating Humidity	0 ~ 95% RH, no condensation		
What is in the Box	Presence Switch H2 US × 1, Compliance Statement × 1, User Manual × 1, Screw Kit × 1, Wire Nuts Kit × 1, Wiring Sticker Sheet × 1		