

Tybox 117+



www.deltadore.com

Contents

Installation

1. Installing the transmitter	3
1.1 Location.....	3
1.2 Mounting/Connection	3
2. Time and date setting	4
3. Configuring your device (Menu 1)	5
Menu 1-02 Programme duration.....	5
Menu 1-03 Pre-heat activation/deactivation.....	5
Menu 1-08 Controlling the Comfort temperature	5
Menu 1-09 Anti-seize activation/deactivation	5
4. Configuring your device (Menu 2)	6
Menu 2-01 Locking or unlocking the settings.....	6
Menu 2-02 Correcting the measured temperature	6
Menu 2-04 Temperature displayed in AUTO mode (setpoint or room).....	6
Menu 2-05 12h/24h time format.....	6
Menu 2-06 Automatic summer/winter changeover.....	6
Menu 2-07 Days until boiler/heat pump service reminder	7
Menu 2-08 Control time base	7
Menu 2-11 Hysteresis setting (if 2-08 = tor).....	7
Menu 2-17 Resetting the boiler/heat pump operating hours meter.....	7
5. Settings reset	8
6. Technical characteristics	8

1. Description	9
2. Automatic mode (AUTO).....	9
3. Override	9
4. Information button	10
5. Time setting.....	10
6. Adjusting temperature settings	10
7. Programming.....	11
7.1 Quick programming	11
7.2 Customising a programme	12
7.3 Programme verification	13
7.4 Return to initial programme	13
8. Manual mode	14
9. Absence mode	14
10. Off mode.....	14
11. Pre-heat function.....	15
11.1 Changing batteries	15
11.2 Frequently Asked Questions (FAQ).....	15

INSTALLATION

1. Installing the transmitter

1.1 Location

The thermostat can be wall-mounted in a room where the temperature is to be regulated from, at a recommended height of 1.5m and away from any heat sources (fireplace, direct sunlight, etc.) or draughts (window, door, etc.).

To avoid unwanted air movements that would distort the sensor measurement, the wire entry into the flush-mounted box must be plugged (mastic, glass wool, etc.).

IMPORTANT: Do not install the thermostat on a wall in contact with the outside or with an unheated room (e.g. garage, etc.).

1.2 Mounting/Connection

- 1 Switch off the power to your setup.
- 2 Separate the box from its base.
- 3 Connect and secure the base. Your Tybox must be connected with flexible or rigid cables with a maximum cross-section of 1.5 mm².
- 4 Insert the batteries
WARNING: make sure you insert the batteries facing the right way and that they are the right type (no lithium batteries).
- 5 Toggle the switch to choose the programme type: weekly (A) or daily (B).
- 6 7 Close and lock the box.
- 8 Turn on the power to your setup.

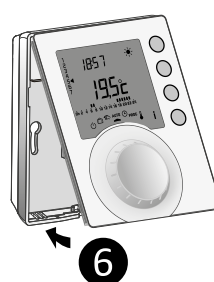
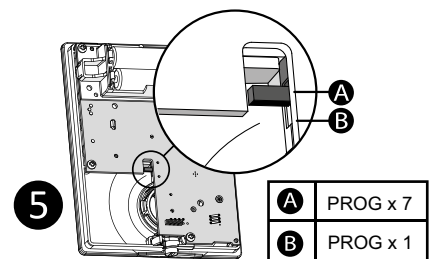
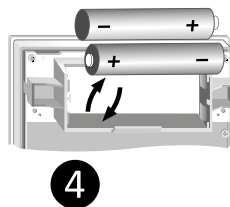
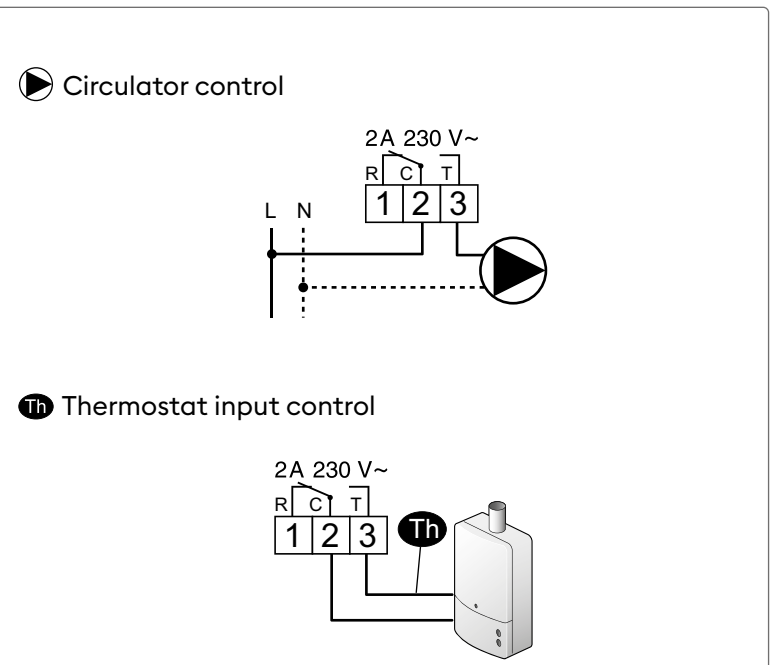
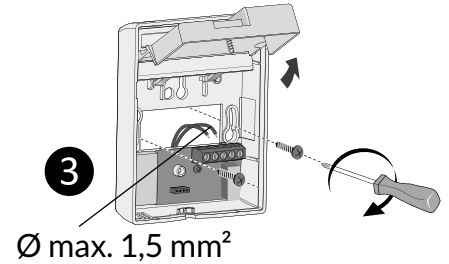
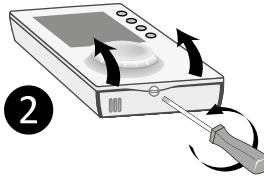
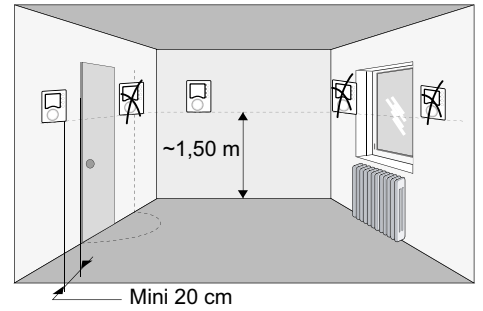
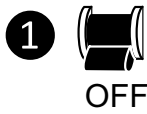
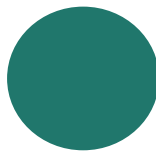

2. Time and date setting

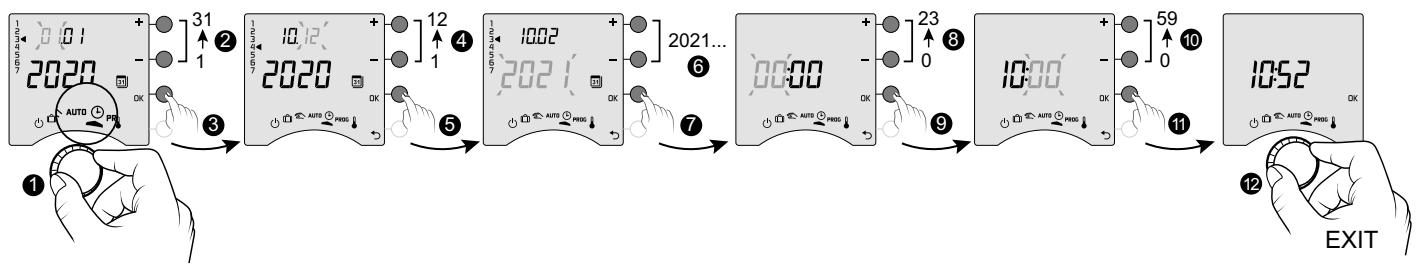

① Turn the dial to ⌚.

② -> ⑥ Set the day, month, year with + or -.

⑦ Confirm with OK.

⑧ -> ⑩ Set the hour then the minutes with + or -.

⑪ Confirm with OK.

⑫ To exit the mode, turn the dial.

3. Configuring your device (Menu 1)

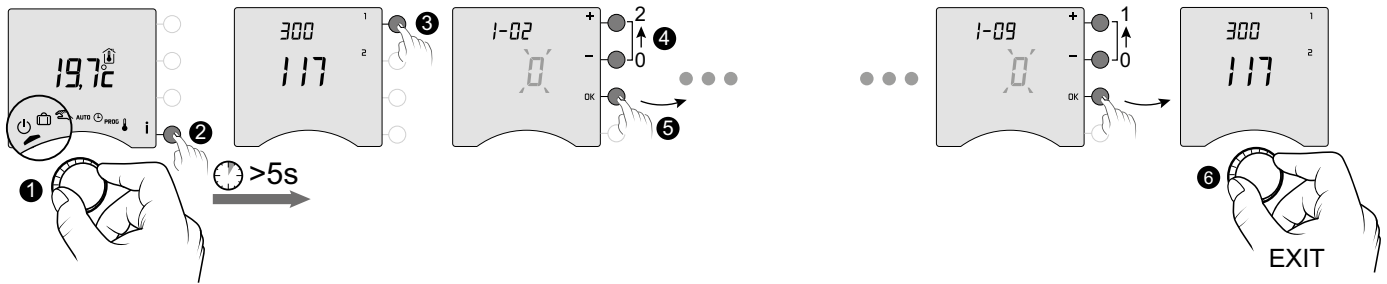

① Turn the dial to , then press the **i** button for 5 seconds (②).

③ Press the **1** button. To change the various settings, press the **+** or **-** buttons (④), then press **OK** to confirm the change and go to the next setting (⑤).

⑥ To exit the mode, turn the dial.

Menu 1-02 Programme duration

You can set programming by the hour, half hour, or quarter of an hour. Default setting: 1 hour.

0	60 min.
1	30 min.
2	15 min.

Menu 1-03 Pre-heat activation/deactivation

Pre-heat means you can enjoy the Comfort temperature you want at the scheduled hour (see § “Pre-heat function”).

Default setting: Pre-heat off

0	Pre-heat off
1	Pre-heat on

Menu 1-03 does not appear if the Comfort temperature is controlled by each radiator (menu 1-08 = 1).

Menu 1-08 Controlling the Comfort temperature

For hot water heaters with thermostatic valves, the Comfort temperature can be provided by adjusting the thermostat on each radiator.

In AUTO mode, the device will show “Conf” during Comfort periods and will be set to constant heating. Only the Economy and Frost Protection temperatures are controlled by the Tybox.

Default setting: Comfort temperature is controlled by the Tybox.

0	Comfort temperature controlled by Tybox
1	Comfort temperature controlled by each radiator

Menu 1-08 does not appear if pre-heat is active (1-03 = 1). Choice 1 turns off pre-heat (1-03 = 0). In this case, menu 1-03 no longer comes up.

Menu 1-09 Anti-seize activation/deactivation

Anti-seize can be used outside heating periods to regularly start up the circulator/boiler/heatpump during off periods (5 minutes/week).

Default setting: Anti-seize off

0	Anti-seize off
1	Anti-seize on

4. Configuring your device (Menu 2)

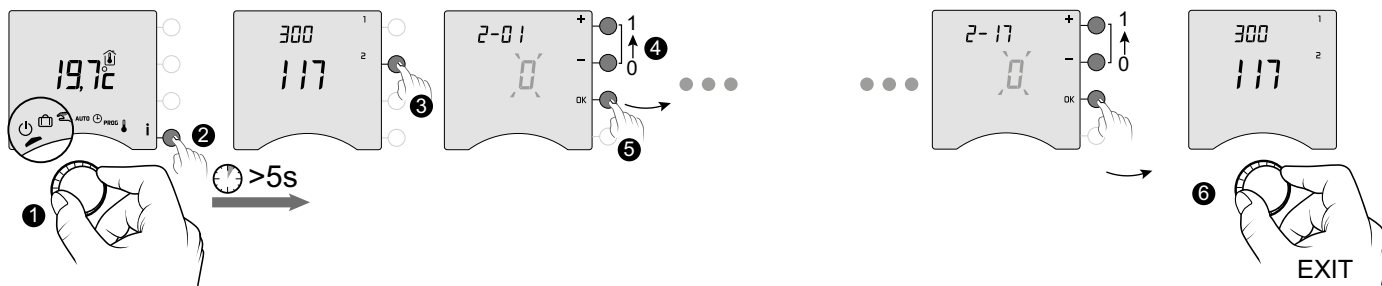

① Turn the dial to , then press the **i** button for 5 seconds (②).

③ Press the 2 button. To change the various settings, press the + or - buttons (④), then press OK to confirm the change and go to the next setting (⑤).

⑥ To exit the mode, turn the dial.

Menu 2-01 Locking or unlocking the settings

This menu enables you to authorise or lock changes to the settings such as programming or setpoint temperatures. Locking only applies to settings entered via the Tybox.

Default setting: Changes allowed

	Changes allowed
	No changes to the programme. Adjusting setpoint temperature settings.

Adjustment in manual and Comfort mode limited to between 5°C and 22°C.
Economy setting limited to between 5°C and 19°C.
Frost protection setting limited to between 5 and 11°C.

Menu 2-02 Correcting the measured temperature

This menu is used to correct any difference you have noticed between the displayed temperature and the measured temperature.

Example: If the temperature displayed by the device is 19°C and the measured temperature is 20°C, change to +1°C then confirm using OK.

Default setting: 0°C

	Adjusts from -5°C to 5°C, in increments of 0.1°C.
--	------------------------------------------------------

In order to change this setting, the unit must have been running for at least 2 hours beforehand.

Menu 2-04 Temperature displayed in AUTO mode (setpoint or room)

Default setting: setpoint temperature displayed.

	Displays setpoint temperature
	Displays room temperature

In normal use, press the **i** button to check one or other of the temperatures.

Menu 2-05 12h/24h time format

Default setting: 24h

	24 h
	12 h

Menu 2-06 Automatic summer/winter changeover

Default setting: Automatic changeover

	No automatic changeover
	Automatic changeover

Menu 2-07 Days until boiler/heat pump service reminder

Must be reset after every service.
Default setting: "---" (function off).

Adjustable "---" (function off) or from 1 to 365 days

If you don't want to use this function, leave the setting on "---".

Menu 2-08 Control time base

The control quality depends on parameters like the building's insulation, the number of radiators or the flooring type. The "Tips" column in the following table will help you select the setting that is appropriate for your setup. Default setting: 15 minutes.

	Choice of control type	Heater type	Generator type	Tips
15	15 minutes ⁽²⁾	Radiator	Boiler/Heat pump ⁽¹⁾	Increase the time base to extend generator run times and thus prevent starting up so often.
30	30 minutes ⁽²⁾	Radiator Underfloor heating	Boiler/Heat pump ⁽¹⁾	
45	45 minutes ⁽²⁾	Underfloor heating	Boiler/Heat pump ⁽¹⁾	Reduce the time base if you notice big differences in temperature.
60	60 minutes ⁽²⁾	Underfloor heating	Heat pump ⁽¹⁾	
tor	All or nothing/ On-off	Radiator Underfloor heating	Heat pump ⁽¹⁾	Only recommended if the PID control isn't satisfactory. Recommended hysteresis value: between 0.4 and 1
		Oven range heating		Hysteresis value: follow the value recommended by the range's manufacturer

- (1) The control is fitted with anti-short cycle protection to suppress start or stop requests when they are too short. The anti-short cycle duration is 10% of the time base selected (e.g.: if the time base is set to 30 minutes, the anti-short cycle will be 3 minutes, i.e. the thermostat will not accept any start or stop requests that are under 3 minutes).

(2) PID control time base:

Menu 2-11 Hysteresis setting (if 2-08 = tor)

Default setting: 0.4°C.

Adjusts from 0.2°C to 2°C,
in increments of 0.1°C.

Example:
Setpoint 20°C. Hysteresis 0.4°C.
Heating request if T° measured <19.8°C.
Heating shuts down if T° measured > 20.2°C.

Menu 2-17 Resetting the boiler/heat pump operating hours meter

Default setting: Off

0	No
1	Yes

Once the reset is applied, the 2-17 menu automatically switches back to 0.

5. Settings reset

The default factory settings may be restored for each of the menus.

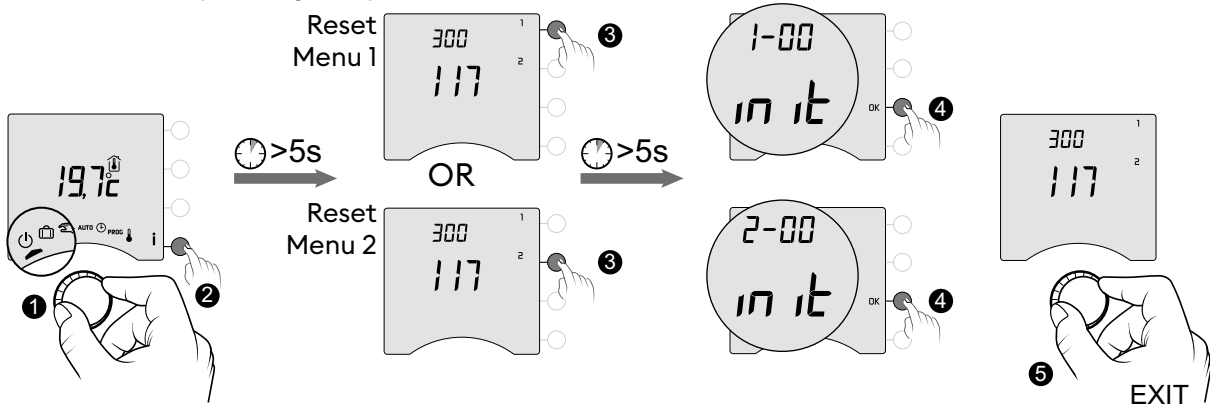

1 Turn the dial to , then press the **i** button for 5 seconds (2).

3 Press the button on the menu you wish to reset, and hold the button for 5 seconds.

4 Then press the OK button to confirm the reset.

5 To exit the mode, turn the dial.

6. Technical characteristics

- Power supply using batteries: 2 x 1.5 V Alkaline - Type LR03-AAA
- Class II insulation
- Change-over contact output 2 A max., 230V ~
- Type I.C automated action
- Dimensions: 80 x 103 x 25 mm
- Protection rating: IP 30

- Installation in an environment with normal pollution levels
- Storage temperature: -10°C /+70°C
- Operating temperature from -10°C/+40°C
- Ball test temperature: 75°C (Housing), 100°C (Terminal block)
- Rated impulse voltage: 2,500V

1. Description

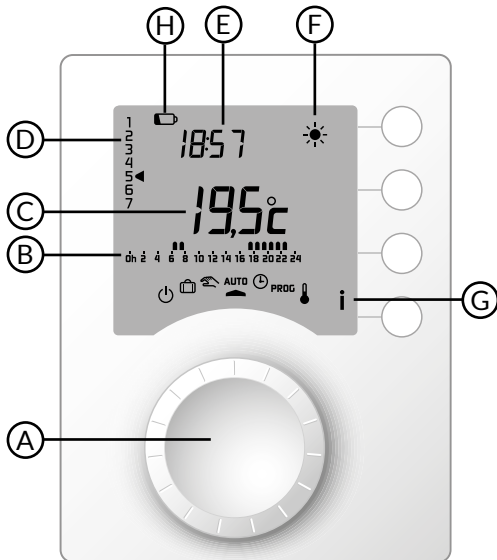

- (A) Selector dial
- (B) Programme profile
- (C) Room
- (D) Day (1 = Monday)
- (E) Time
- (F) Current setpoint
- (G) Information
- (H) Low batteries

- Off mode
- Absence mode
- Manual mode
- AUTO** Follows programming
- Date and time settings
- PROG** Programming
- Adjusting setpoint temperature settings
- Comfort
- Economy
- Frost protection

2. Automatic mode (AUTO)

Turn the selector dial to AUTO.

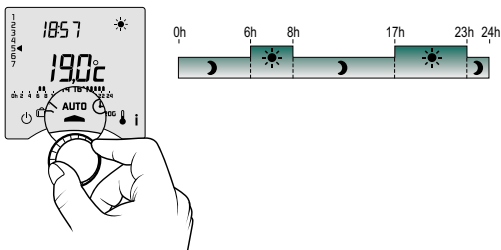

Your thermostat will function according to the set programme.

Depending on the configuration during installation, your unit will continuously display the setpoint temperature or the room temperature (menu 2-04).

If you are in the programmed Economy period, and the symbol flashes and the Comfort setpoint is displayed, it's because pre-heating is in progress (see § Pre-heat function).

3. Override

In AUTO mode, you can use the override to change the setpoint temperature until the next programmed point.

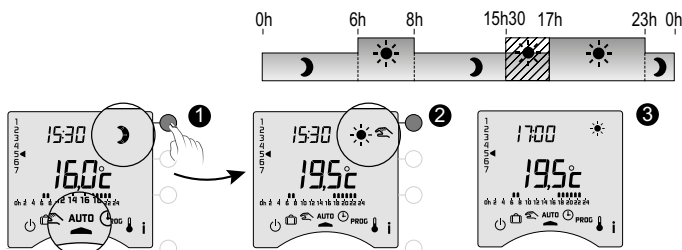

Example: it is 15:30 and you would like to switch to Comfort mode before the set time (17:00).

- 1** Press the button
- 2** Override in progress
- 3** At 17:00, the programme will return to its usual schedule.

To cancel the current override, press the button once more.

4. Information button

In AUTO, manual or off mode, successive presses on the **i** button enable you to:

- find out the room temperature or the setpoint temperature (depending on the configuration during installation (menu 2-04),
- show the boiler/heat pump operating hours meter, as well as the number of days remaining before maintenance (if this setting is on, menu 2-07),
- show any faults (see § “Changing batteries”).

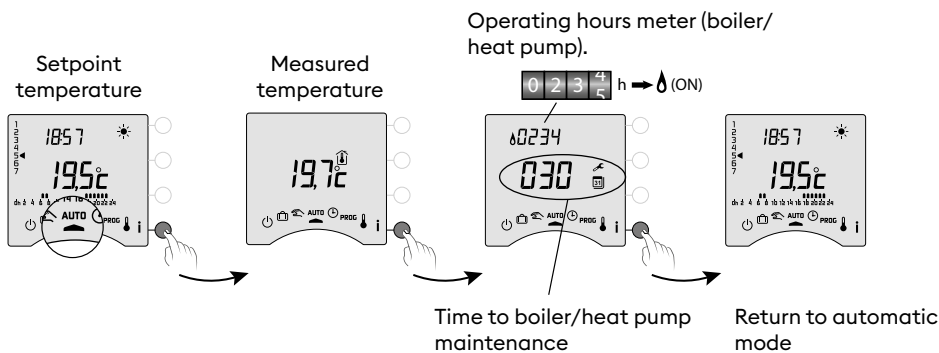

5. Time setting

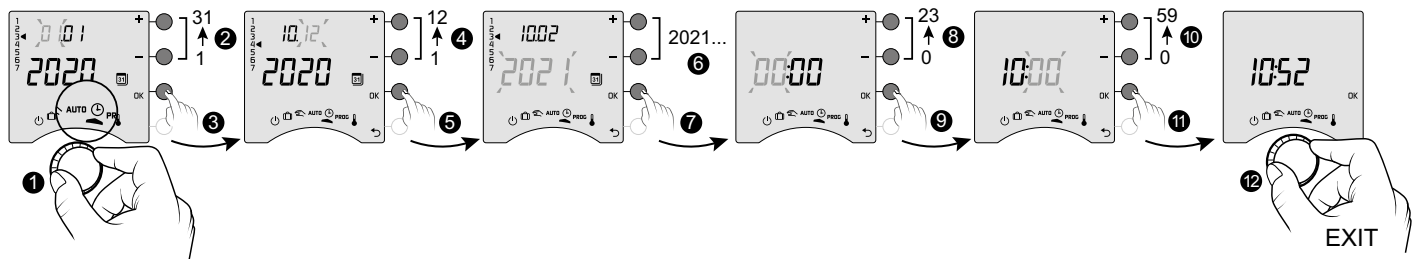

1 Turn the dial to

2 -> 6 Set the day, month, year with + or -.

7 Confirm with OK.

8 -> 10 Set the hour then the minutes with + or -.

11 Confirm with OK.

12 To exit the mode, turn the dial.

6. Adjusting temperature settings

- If the Comfort temperature is controlled by each radiator (menu 1-08 = 1), you can only set Economy and Frost protection temperatures.
- The temperature settings may be restricted (menu 2-01 = 1).

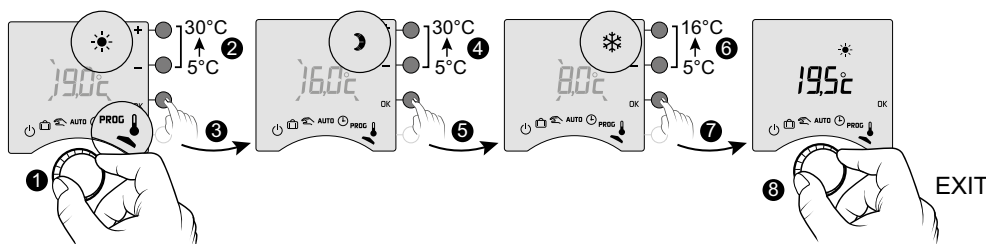

1 Turn the dial to .
The Comfort setpoint temperature flashes.

2 3 Press + or - to adjust, then press OK to confirm and go to the next setting.

4 -> 7 Repeat the operations to adjust the Economy and Frost protection temperatures.

5 To exit the mode, turn the dial.

- Comfort (from 5°C to 30°C)
- Economy (from 5°C to 30°C)
- Frost protection (5°C to 16°C)

7. Programming

You can opt for weekly (PROGx7) or daily (PROGx1) programming.

You can select your choice using the switch on the back of the device.

You can programme in increments of one hour, 30 minutes or 15 minutes (menu 1-02).

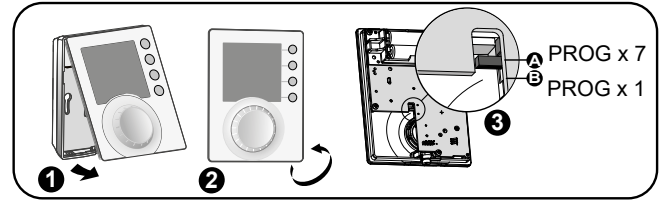

An pre-heatfunction is available on this product (see § Pre-heat function).

There are two phases of programming :

1 Quick programming:

Choose from among the pre-set programmes available (P1 -> P5) and apply it (see table).

For daily programmes (PROG x1), only P1 and P5 are available.

2 Programme customisation :

Customise the programme profile applied to a day based on preferences.

			PROG x7	PROG x1
P1		Monday -> Sunday	✓	✓
P2		Monday -> Friday	✓	
		Saturday, Sunday		
P3		Monday -> Friday	✓	
		Saturday, Sunday		
P4		Monday, Tuesday, Thursday, Friday	✓	
		Wednesday, Saturday, Sunday		
P5		Monday -> Sunday	✓	✓

7.1 Quick programming

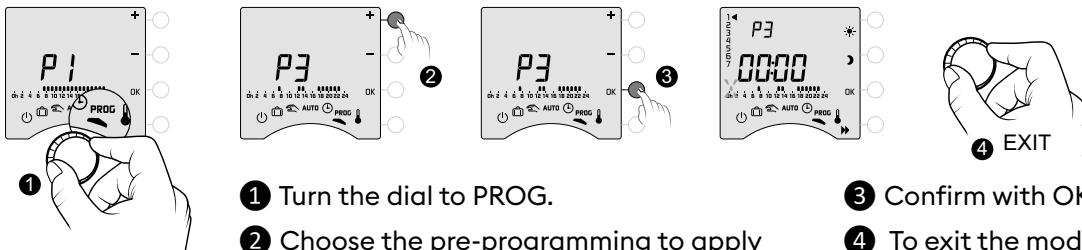

1 Turn the dial to PROG.

2 Choose the pre-programming to apply (see table) by successively pressing + or -.

3 Confirm with OK.

4 To exit the mode, turn the dial.

7.2 Customising a programme

How to set a daily programme (PROG x1)

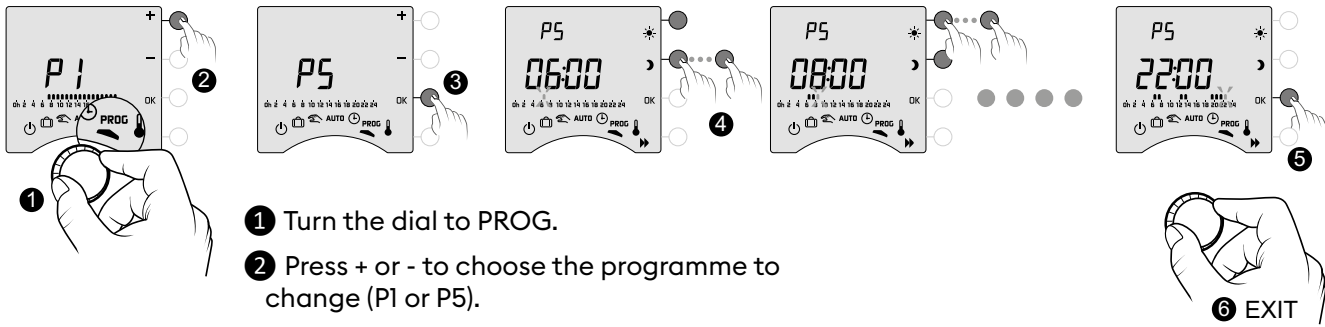

- 1 Turn the dial to PROG.
- 2 Press + or - to choose the programme to change (P1 or P5).
- 3 Confirm with OK.
The programme profile flashes.
- 4 Create your programme by pressing ☾ for Economy periods and ☀ for Comfort periods.

You can check your programme by pressing the ►► button (see § Programme verification).

- 5 Confirm with OK.
- 6 To exit the mode, turn the dial.

How to set a daily programme (PROG x7)

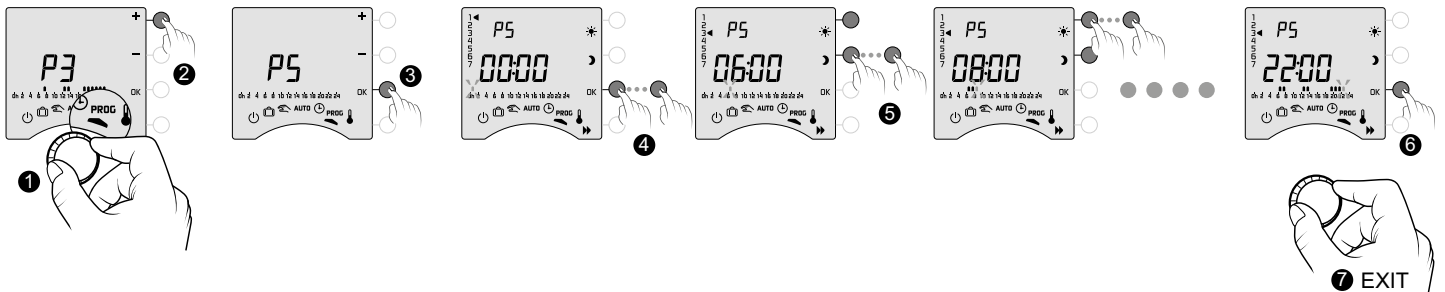

- 1 Turn the dial to PROG.
- 2 Press + or - to choose the programme to change.
- 3 Confirm with OK.
The programme profile flashes.
- 4 Press OK to choose the day to change.
Programming begins on day 1 (Monday) and at 12 a.m.
1: Monday, ... 7: Sunday,

- 5 Create your programme by pressing ☾ for Economy periods and ☀ for Comfort periods.
You can check your programme by pressing the ►► button (see § Programme verification).
- 6 Confirm with OK and go to programming for the next day
OR copy the programme to the next day (COPY function) by pressing OK for 3 seconds.
Repeat for each day of the week.
- 7 To exit the mode, turn the dial.

COPY function

Used to copy the programme from one day to the next.

To do this, press and hold the OK (6) button for 3 seconds.

The arrow will move to the next day, ensuring the copy has occurred

7.3 Programme verification

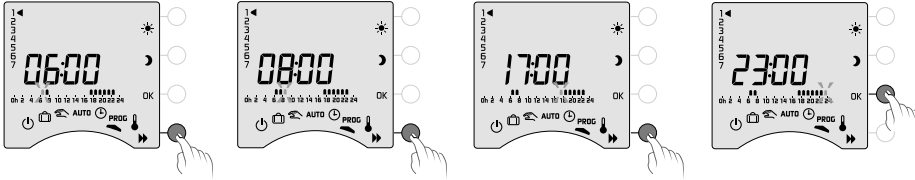

Once your programme has been changed, you can check it by successively pressing the button ►►.

If it suits you, confirm with OK and go to the next day (if PROGx7).

To exit the mode, turn the selector dial.

7.4 Return to initial programme

You want to reset to the initial programmes.

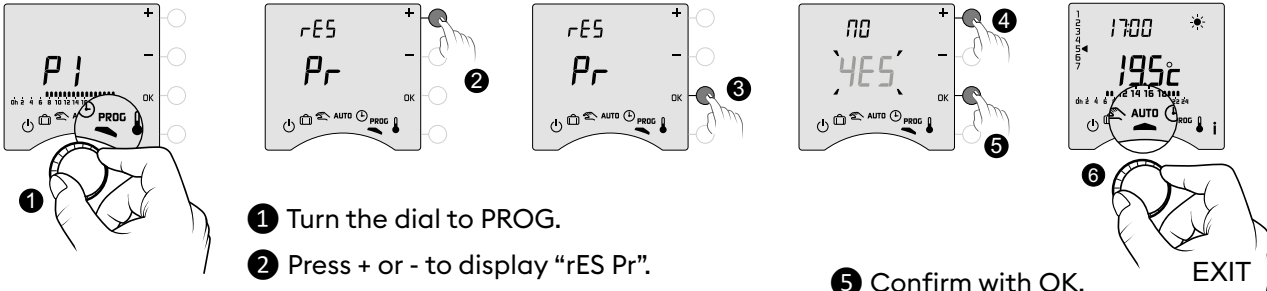

- 1 Turn the dial to PROG.
- 2 Press + or - to display "rES Pr".
- 3 Confirm with OK.
- 4 Press + or - to make "YES" flash.

- 5 Confirm with OK.
- 6 To exit the mode, turn the dial.

8. Manual mode

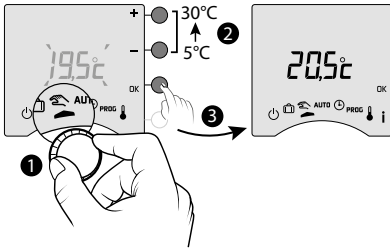

This mode is used to choose a temperature setting (5 to 30°C) that remains constant. This setting may be restricted (menu 2-01 = 1). Turn the dial to exit the mode.

In this mode, all programming is ignored.

9. Absence mode

S	20	🏠
D	21	
L	22	
M	23	
M	24	👤
J	25	
V	26	
S	27	
D	28	👤
L	29	

This mode sets your home heating to Frost Protection if you are away for several days. The Frost protection setpoint is adjustable (see «Adjusting temperatures»).

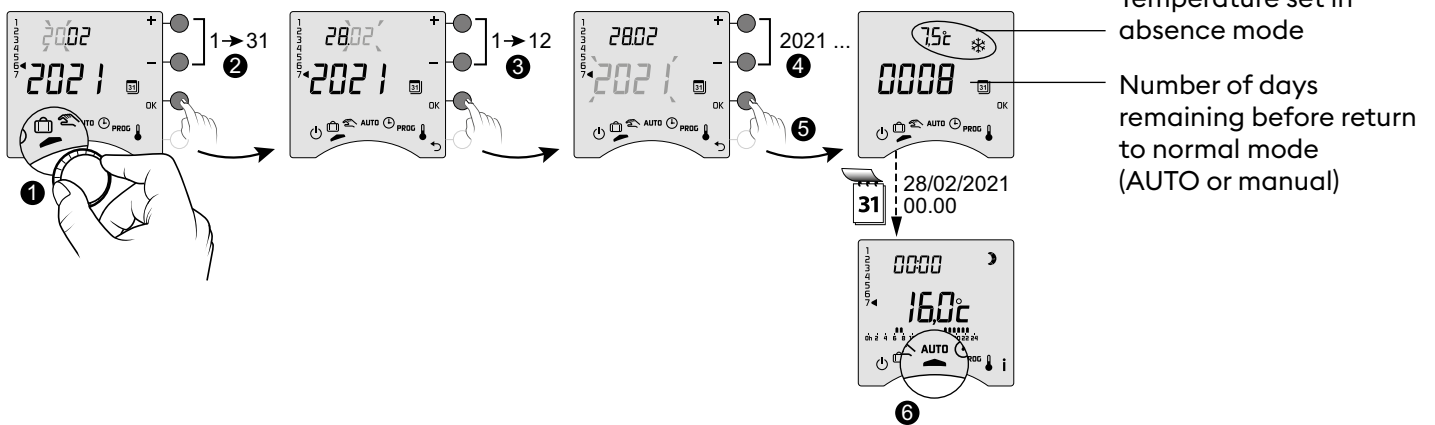

① Turn the dial to .

② -> ④ Set the return date with + or -, then confirm with OK (⑤). The countdown begins.

⑥ Return to initial mode (AUTO or manual) at the end of the countdown, at 0h00.

- To make changes to the current mode, press OK.
- To cancel, turn the selector dial.

10. Off mode



This mode switches off your heating system. Turn the dial to .

In this mode, the thermostat only displays the room temperature.



11. Pre-heat function

When changing from Economy to Comfort temperature in AUTO mode, your thermostat will anticipate the rise in temperature so that it reaches the right temperature at the scheduled time.

Example (see opposite): 6:30 am, Economy period, currently pre-heating to reach the temperature of 20°C at 8:00 am.

The pre-heating function's speed and accuracy is based on the heater type used and its heating inertia..

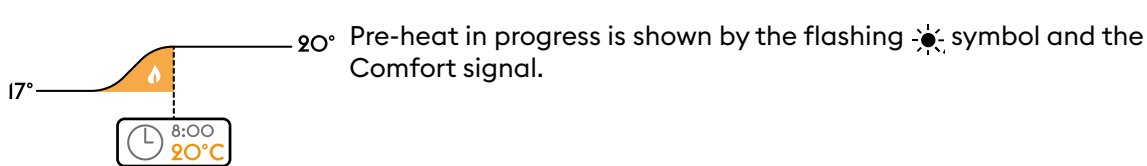

11.1 Changing batteries

• **The symbol  appears.**

You have approximately 1 month to replace the batteries (either two LR03 or AAA 1.5 V alkaline batteries).

WARNING: make sure you insert the batteries facing the right way and that they are the right type (no lithium batteries).

You have 30 seconds to change the batteries before the time setting is lost (in this case, you will need to reset the date and time).

The configuration and programming are stored in case the power is off for a long time.

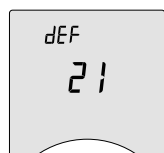
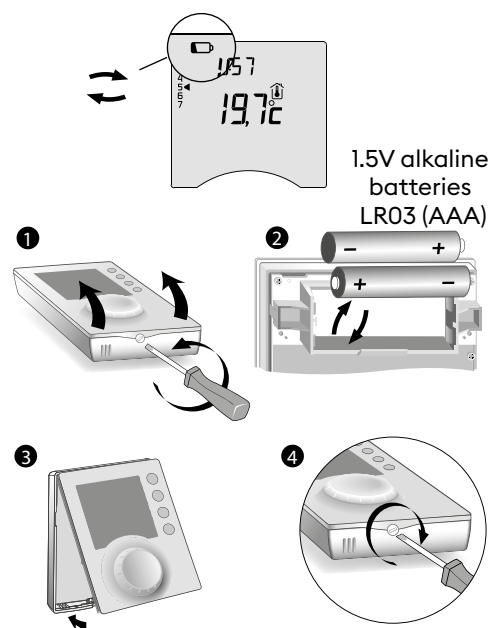

• **The display shows dEF21.**

You have passed the 1 month limit for low batteries. You **MUST** change the batteries in your device.

11.2 Frequently Asked Questions (FAQ)

• **The thermostat is on despite the programme not calling for it.**

You must have turned on the pre-heat function. If so, then it is normal for your thermostat to anticipate the temperature rise and it has started pre-heating to get to the Comfort temperature at the desired time (see § Pre-heat function).

• **The thermostat turns off though the requested temperature has not yet been reached.**

Your thermostat uses a kind of control that anticipates the inertia in temperature variations in order to calculate energy needs as accurately as possible and provide maximum comfort.

On the other hand, anticipating a drop in temperature, the heating may turn on once the desired temperature has been reached.