

Our Place®

Dream Cooker™ User Manual

APL.MCK.ESN

120V 60Hz 1200W

6QT / 6L

15.16 x 12.44 x 13.15 in / 38.5 x 31.6 x 33.4 cm

12.87lbs / 5.84kg



DREAMS NEVER TASTED SO GOOD

Your new Dream Cooker is here to unlock your kitchen imagination in the **yummiest ways possible**. From fork-tender carnitas to **impossibly fluffy rice to comforting soups and stews, nothing is off limits with this all-in-one countertop wonder**. It takes the pressure off pressure cooking. It'll slow cook if you want or deliver equally delicious results in record time — all while keeping it warm until you're ready. So kick back and start dreaming big about what's going to be on your table next.

▲ IMPORTANT

SAVE THESE INSTRUCTIONS

Please read and keep these instructions handy. These instructions will help you learn to use your Dream Cooker properly and thoroughly so that you can achieve consistent, professional results.

**FOR HOUSEHOLD USE ONLY. NOT
INTENDED FOR COMMERCIAL USE.**

Contents

Important Safeguards	1
Safety Precautions	5
Parts and Accessories	11
Control Panel	16
Before First Use	19
Instructions for Use	20
Cleaning and Maintenance	27
Troubleshooting	29
Replacement Parts	31
Warranty	32

SAVE THESE INSTRUCTIONS.

FOR HOUSEHOLD USE ONLY. NOT INTENDED FOR COMMERCIAL USE.

IMPORTANT SAFEGUARDS

Read all instructions carefully and thoroughly before first use. When using electrical appliances, basic safety precautions should always be followed including the following:

1. Do not touch hot surfaces. Use handles. Never move the appliance while it's in use.
2. Use on a flat, stable, heat-resistant surface away from heat sources or liquids.
3. Close supervision is necessary when any appliance is used by or near children.
4. This appliance cooks under pressure. Improper use may result in burn injuries. Make sure to always properly lock and seal the lid before pressure cooking. See INSTRUCTIONS FOR USE.
5. To protect against electric shock, do not immerse the cooker base, cord, or plug in water or liquid.
6. Do not let the cord hang over the edge of a table or counter, or touch hot surfaces.
7. Do not operate the appliance with a damaged cord and/or plug, after the appliance malfunctions or after it has been damaged in any manner. If the appliance malfunctions or has been damaged in any way, email hello@fromourplace.com.
8. The use of accessory attachments not recommended by the appliance manufacturer may cause hazard or injury.
9. Unplug the appliance from the outlet when not in use, or before cleaning.
10. **Allow the appliance to cool completely before putting on or taking off any parts and before cleaning.**
11. To disconnect, press the START/STOP button to return to Standby mode, and then unplug the plug. When unplugging the appliance, always hold the plug to remove it from the outlet. Do not pull the cord. Always attach the plug to the appliance first, then plug the cord into the wall outlet.
12. Do not use this appliance for pressure frying with oil.
13. Do not lean over or place your hands or face over the appliance while it is in operation. Do not touch the lid cover when the appliance is in operation.

SAVE THESE INSTRUCTIONS.

FOR HOUSEHOLD USE ONLY. NOT INTENDED FOR COMMERCIAL USE.

This could result in injury.

14. **WARNING:** Spilled food can cause serious burns. Keep appliance and cord away from children. Never drape the cord over the edge of counter, never use outlet below counter and never use with an extension cord.
15. Do not exceed the maximum fill line.
16. Do not place any of the following materials in the pot: cardboard, plastic, paper, or anything similar which may catch fire or melt.
17. Do not store any materials, other than manufacturer's recommended accessories and the inner cooking pot, in this appliance when not in use.
18. Never use your appliance without adding liquid, as this will seriously damage the appliance.
19. Be aware that certain foods, such as applesauce, cranberries, pearl barley, oatmeal or other cereals, split peas, noodles, macaroni, rhubarb, or spaghetti can foam, froth, and sputter, and clog the pressure release device (steam vent). These foods should not be cooked in a pressure cooker.
20. Be careful not to be scalded by the hot steam when opening the lid or when placing the food inside the inner cooking pot.
21. Do not block any ventilation openings. Hot steam is released through openings.
22. Do not touch the steam release valve or the area near the valve while cooking. Do not cover the area with a cloth.
23. Do not use outdoors. Do not use the appliance for anything other than intended use.
24. This appliance is for HOUSEHOLD USE ONLY.
25. The temperature of the lid cover and the outer surface may be higher when the appliance is working.
26. Temperature of accessible surfaces may be high when the appliance is operating.
27. This appliance is not intended for use by persons (including children) with reduced physical, sensory or mental capabilities or lack of experience and knowledge, unless they have been given supervision or instruction concerning use of the appliance by a person responsible for their safety.
28. Children should be supervised to ensure that they do not play with the appliance.

SAVE THESE INSTRUCTIONS.

FOR HOUSEHOLD USE ONLY. NOT INTENDED FOR COMMERCIAL USE.

29. WARNING: This appliance includes a heating function. Surfaces, other than the functional surfaces, may develop high temperatures.
30. Always use heat-resistant gloves, pads, or oven mitts when handling hot materials.
31. Allow the appliance to cool completely before touching. Do not place the appliance on or near a hot gas or electric burner or in a heated oven.
32. To reduce the risk of electrical shock, never use the appliance without the inner cooking pot in place.
33. Ensure the heating plate is clean and the underside of the inner cooking pot is dry before inserting it.
34. Do not touch the heating element after cooking, as it will be hot and may cause burns.
35. Do not open the appliance until the unit has cooled and all internal pressure **has been released. If the handles are difficult to push apart, this indicates** that the appliance is still pressurized – do not force it open. Any pressure in the appliance can be hazardous. See INSTRUCTIONS FOR USE.
36. Extreme caution must be used when moving an appliance containing hot liquids.
37. Always place the inner cooking pot on a heat-resistant surface after removing it from the cooker base.
38. Cleaning and maintenance shall not be done by children without supervision.
39. If there is a foreign object between the inner cooking pot and heating plate, remove it before use. Keep the heating plate dry and clean.
40. Cooking meat with skin may swell under pressure. Do not prick the meat while the skin is swollen, as you may be burned.
41. To prevent deformation of the inner cooking pot, do not hit it or drop it on the ground. Only the manufacturer-provided inner cooking pot should be used with the appliance. Do not use the inner cooking pot with any other appliances or to heat on the stove or grill, or in an oven or microwave.
42. The inner cooking pot has a non-stick coating. Do not use sharp or metal utensils to remove food from the appliance. Please use silicone, plastic or wooden tools.
43. INTENDED FOR COUNTERTOP USE ONLY.

SAVE THESE INSTRUCTIONS.

FOR HOUSEHOLD USE ONLY. NOT INTENDED FOR COMMERCIAL USE.

44. A SHORT POWER-SUPPLY CORD IS USED TO REDUCE THE RISK OF IT BEING GRABBED, ENTANGLED IN OR TRIPPED OVER.
45. DO NOT USE A POWER ADAPTER.
46. Your cooker has a 3-prong grounding plug, and should only be used with 120V, 60Hz electrical systems in North America. Always plug in to a grounded electrical outlet. Do not modify the plug in any way.
47. Do not fill the appliance over 2/3 full. When cooking foods that expand during cooking such as rice or dried vegetables, do not fill the unit over 1/2 full. Over-filling may cause a risk of clogging the vent pipe and developing excess pressure. See "Overfill During Pressure Cooking"
48. Always check the pressure release devices for clogging before use.
49. When the normal operating pressure is reached, turn the heat down so all the liquid, which creates the steam, does not evaporate.
50. A short power-supply cord is used to reduce the risk resulting from it being grabbed by children, becoming entangled in, or tripping over a longer cord.
51. SAVE THESE INSTRUCTIONS



CAUTION

1. RISK OF ELECTRIC SHOCK. ONLY COOK IN THE REMOVABLE INNER COOKING POT.
2. APPLIANCE SURFACES ARE HOT DURING AND AFTER COOKING.
3. NOT FOR COMMERCIAL USE. FOR HOUSEHOLD USE ONLY.

SAVE THESE INSTRUCTIONS.

FOR HOUSEHOLD USE ONLY. NOT INTENDED FOR COMMERCIAL USE.

SAFETY PRECAUTIONS

General Instructions

- **Read all instructions carefully and thoroughly.**
- To eliminate choking hazards for young children, remove and safely discard any packing materials before using the appliance for the first time.
- Take inventory of all contents to ensure you have all parts needed to properly and safely operate your appliance.
- **Unplug appliance from outlet when not in use and before cleaning. Allow to cool before cleaning or handling, and putting on or taking off parts.**

Placement

- **INTENDED FOR COUNTERTOP USE ONLY.** Ensure the surface is stable, non-combustible, level, clean, and dry. **DO NOT** place the appliance near the edge of a countertop during operation.
- **DO NOT** place the appliance on or near hot surfaces, on or near a gas or electric burner, or in a heated oven.
- **DO NOT** use near water or flames.
- **DO NOT** use outdoors. Keep out of direct sunlight. **DO NOT** use in moving vehicles or boats.
- When using this appliance, provide adequate space (at least 5 inches above and at least 3 inches on all sides) for air circulation.
- To avoid possible steam damage, place the appliance away from walls and cabinets during use. **DO NOT** use under cabinets or in an enclosed space.
- When the appliance is in operation, hot steam is released through the steam release vent cover. Place the appliance so the steam release vent cover is not directed toward the power cord, electrical outlets, cabinets or other appliances.
- **DO NOT** block the steam release vent cover. Keep your hands and face a safe distance from the vent.
- Keep the appliance and its cord out of reach of children. **DO NOT** allow the appliance to be used by children or persons with reduced physical, sensory, or mental capabilities. Close supervision is necessary when the appliance is used by or near children and persons with reduced physical, sensory, or mental capabilities.

General Use

- **ALWAYS** ensure the appliance is properly assembled before use.
- Before placing the inner cooking pot in the cooker base, ensure all parts are clean and dry by wiping with a soft cloth. If there is a foreign object between the inner cooking pot and cooker base, remove it before use.
- **DO NOT** use a damaged inner cooking pot, silicone sealing ring, or lid. Replace before using.
- **DO NOT** use the appliance without the inner cooking pot installed. Doing so could result in electric shock or other injury.
- **DO NOT** move the appliance when in use.
- Only use the side handles to carry or move the appliance. **DO NOT** use the lid knob to carry the appliance.
- **DO NOT** touch hot surfaces. Appliance surfaces are hot during and after operation. To prevent burns or personal injury, **ALWAYS** use heat-resistant gloves, pads, or oven mitts, and use available handles.
- Extreme caution must be used when moving an appliance containing hot oil or other hot liquids. Improper use, including moving the appliance, may result in personal injury such as serious burns.
- The removable inner cooking pot can be extremely heavy when full of ingredients. Care should be taken when lifting the inner cooking pot from the cooker base.
- Use caution when removing the inner cooking pot and lid from the appliance. **ALWAYS** place it on a heat-resistant surface after removing. **DO NOT** touch the appliance and its parts during or immediately after cooking to avoid burn injury. **ALWAYS** use heat-resistant gloves, pads, or oven mitts when handling the appliance, inner cooking pot, or other hot materials.
- **DO NOT** use this appliance for deep-frying. Use only as intended. When sautéing, **ALWAYS** use high smoke point oils and avoid aerosol spray oil.
- **DO NOT** use this appliance to cook instant rice.
- When the removable inner cooking pot is empty, **DO NOT** heat for more than 10 minutes. Doing so may damage the cooking surface.
- **NEVER** use your appliance without adding liquid for Pressure Cook and Slow Cook modes, as this will seriously damage the appliance.
- Should the unit emit smoke, unplug immediately and wait for smoking to stop before removing the inner pot.
- To prevent fire, **DO NOT** cook food directly on the heating element without the inner cooking pot in place.

- Caution should be used when searing and sauteing. Keep hands and face away from the inner cooking pot, especially when adding new ingredients, as hot oil may splatter. This could result in burns or personal injury.
- **DO NOT** lean over or place your hands or face over the appliance while it is in operation. This could result in burns or personal injury.
- The inner cooking pot has a ceramic nonstick coating. **DO NOT** use sharp or metal utensils to remove food from the inner cooking pot. Please use silicone or wooden tools to prevent damage to the nonstick coating.
- This appliance is for household use only. **DO NOT** use this appliance for anything other than its intended use. Misuse may cause injury.

Pressure Cooking and Slow Cooking

- This appliance cooks under pressure. Improper use may result in scalding injury, personal injury, and/or property damage.
- When using the Slow Cook and Pressure Cook modes, **ALWAYS** keep the lid closed. Ensure the silicone sealing ring is installed properly and the lid is properly assembled and closed before operating. See page 14 for further instructions.
- Before use, **ALWAYS** check the steam release valve and float valve pin for clogging, and clean if necessary. The float valve pin should move freely up and down when the lid is in proper working order and not in the locked position.
- **ONLY** lift the lid from the knob on the top of the appliance.
- If steam escapes from the steam release valve in a steady stream for over 3 minutes, turn the appliance off. If steam escapes from the sides of the lid, turn the appliance off and make sure the silicone sealing ring is properly installed once the appliance has cooled. See the Parts and Accessories section on page 9 for more information on installing the silicone sealing ring.
- Extreme caution must be used when the appliance contains hot food and liquids and/or is under pressure. Failure to follow all instructions regarding proper use of the appliance may result in unintended contact with hot foods or liquids that have been pressurized, resulting in serious burns.
- **DO NOT** attempt to open the lid during or after pressure cooking until all internal pressure has been released through the steam release valve and the appliance has cooled slightly. The pressure release indicator on the control panel will turn off, and the float valve pin will drop when all pressure has been released. Open lid promptly to avoid re-pressurization of the inner

cooking pot.

- If the lid will not unlock to open, this indicates the appliance is still under pressure — **DO NOT** force the lid open. Any pressure remaining can be hazardous. Let the appliance naturally release pressure or press the manual steam release button. Take care to avoid contact with the releasing steam to avoid burns, personal injury, and/or property damage.
- Meat with skin may swell when cooked under pressure. **DO NOT** prick the meat while the skin is swollen, as you may be burned.
- **DO NOT** tamper with, disassemble, or remove the steam release valve.
- Use extreme caution when removing the lid after cooking. Serious burns can result from the steam inside. **ALWAYS** lift and tilt the lid away from you when removing.
- **ALWAYS** keep hands, face, and other body parts away from the steam release valve prior to or during pressure cooking, and when opening the lid after cooking. Do not touch the steam release valve or the area near the valve while pressure cooking. Serious burns can result from the steam and hot foods inside the inner cooking pot.
- **DO NOT** cover or obstruct the steam release valve. **DO NOT** cover the area with a cloth.

Overfill During Pressure Cooking

- Overfilling may cause a risk of clogging the steam release valve and developing excess pressure.
- **DO NOT** overfill or exceed the maximum fill line. Overfilling may cause **personal injury or property damage or affect safe use of the appliance**. Foods such as apple sauce, cranberries, pearl barley, oatmeal and other cereals, split peas, noodles and pasta can foam, froth, and splatter when pressure cooked. **DO NOT** fill the inner cooking pot past the maximum fill line (designated as “PC MAX”) when cooking these foods.
- When pressure cooking foods that expand (such as dried vegetables, beans, grains, rice, etc.), **DO NOT** fill the pot more than halfway (designated as the “1/2” line on the inner cooking pot), or as otherwise instructed in a recipe.
- **DO NOT** place oversized foods that exceed the maximum fill line (PC MAX) into the inner cooking pot as they may cause risk of fire, personal injury, and/or property damage.

Parts and Accessories

- **DO NOT** use any lid, inner cooking pot, or accessories that are not provided with the appliance or recommended by Our Place. Doing so may cause fire, electric shock, personal injury, and/or property damage.
- **DO NOT** use the inner cooking pot or any other accessories in a microwave, toaster oven, convection oven, or on a ceramic cooktop, electric coil, gas burner range, or outdoor grill.
- To prevent risk or injury, only use silicone sealing rings provided by Our Place as replacement parts. **DO NOT** use if the silicone sealing ring is torn or damaged.

Care and Storage

- Let the appliance cool before handling, cleaning, or storing.
- **DO NOT** place anything — other than the lid — on top of the appliance. When assembled, when in use, and when stored. **DO NOT** store any materials other than the inner cooking pot in this appliance when not in use.
- **DO NOT** place any of the following materials in the appliance: cardboard, plastic, paper, wood, or anything similar which may catch fire or melt.
- Cleaning and user maintenance should not be done by children.
- **DO NOT** use harsh abrasives, caustic cleaners, or oven cleaners when cleaning this appliance. Refer to the Cleaning and Maintenance section on page 27.

Power Cord and Plug

- A short power-supply cord is provided to reduce the risks of children grabbing the cord or becoming entangled in or tripping over a longer cord. **DO NOT** use an extension cord.
- To connect, **ALWAYS** attach the power cord to the appliance first, then plug the power cord into the wall outlet.
- Regularly inspect the appliance and power cord. **DO NOT** use the appliance if there is damage to the power cord or plug. If the appliance malfunctions or has been damaged in any way, email hello@fromourplace.com.
- **Electrical outlet voltages may vary, affecting the performance and heat output of your product.** To prevent possible illness, use a thermometer to check that your food is cooked to the recommended temperatures.
- **DO NOT** use with power converters or adapters, timer switches, or separate

- remote-control systems.
- **To turn off, press the power button, then unplug. When unplugging the appliance, always hold the plug to remove it from the outlet; do not pull the cord.**
- **WARNING:** Spilled food can cause serious burns. Keep the appliance and cord away from children. **NEVER** drape the cord over the edge of the counter. **NEVER** use an outlet below the counter, and **NEVER** use with an extension cord.
- This appliance has a 3-prong grounding plug and should only be used with 120V, 60Hz electrical systems in North America. To reduce the risk of electric shock: **ONLY** plug the power cord into a grounded electrical outlet; **DO NOT** remove ground; **DO NOT** modify the plug in any way.

Electrical Warning

The cooker base contains electrical components that are an electrical shock hazard. Failure to follow these instructions may result in electric shock.

To protect against electric shock:

- **Turn off by pressing the power button and then removing the plug from the power source.** Always unplug when not in use, as well as before adding or removing parts and before cleaning. To unplug, grasp the plug and pull from the outlet. **NEVER** pull from the power cord.
- **DO NOT** attempt to repair, replace, or modify components of the appliance, unless expressly noted as replaceable throughout this user manual, as this may cause electric shock, fire, personal injury, and/or property damage and will void the limited U.S. warranty.
- **DO NOT** tamper with any of the safety mechanisms, as this may result in personal injury or property damage.
- To protect against fire, electric shock, or injury, **DO NOT** immerse the cord, plug or appliance in water or other liquids. **DO NOT** splash water on the appliance.
- **DO NOT** place food or liquid directly into the cooker base. Only the inner cooking pot is designed to contain food or liquid.
- **DO NOT** use appliance in electrical systems other than 120V~/60Hz for North America.
- **DO NOT** clean the appliance by rinsing it under a faucet.

PARTS AND ACCESSORIES

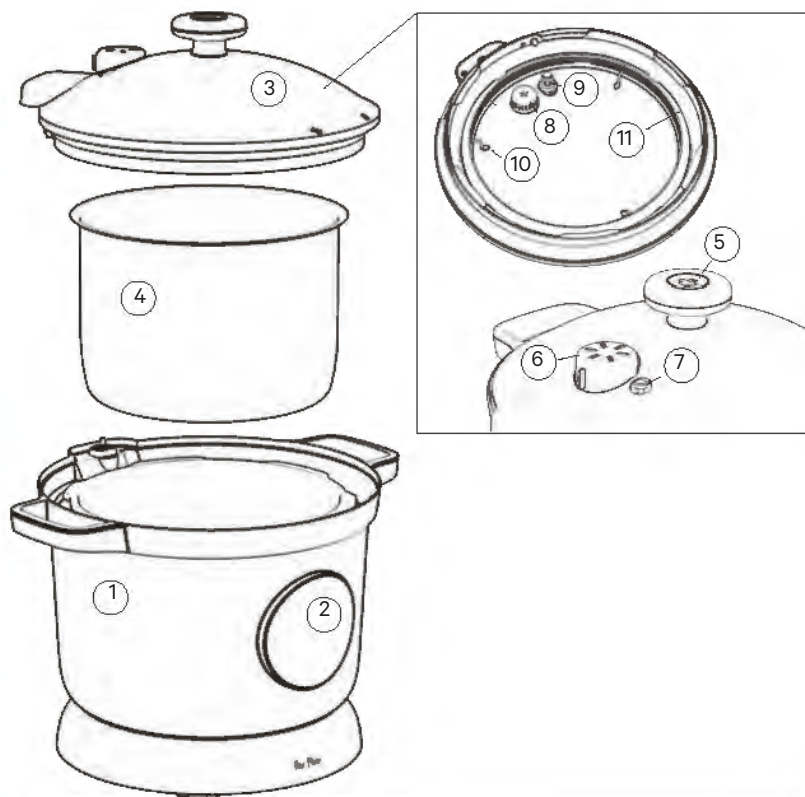

1. Cooker Base	7. Float Valve Pin (Top of Lid)*
2. Control Panel	8. Anti-Clog Cap (Underside of Lid)*
3. Lid	9. Float Valve Pin (Underside of Lid)*
4. Inner Cooking Pot	10. Sealing Ring Holder
5. Manual Steam Release Button (Top of Lid)	11. Silicone Sealing Ring (Underside of Lid)*
6. Steam Release Vent Cover (Top of Lid)*	

*These parts come pre-installed with the appliance.

PARTS AND ACCESSORIES CONTINUED

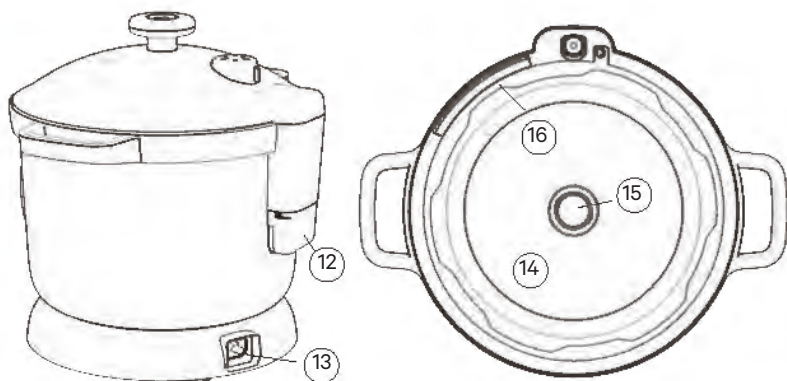

12. Condensation Collector*	15. Heating Plate Sensor (Inside Cooker Base)
13. Power Cord Connection**	16. Condensation Rim (Inside Cooker Base)
14. Heating Plate (Inside Cooker Base)	

*These parts come pre-installed with the appliance.

**Detachable power cord not shown.

Anti-Clog Cap

The anti-clog cap prevents food and debris from entering the steam release pipe. This is a crucial component of the appliance's safety mechanism and it's imperative for regulating pressure while cooking. The anti-clog cap comes pre-installed with the appliance.

Check the anti-clog cap regularly to make sure nothing is blocking it. Proper cleaning of the underside of the lid will help mitigate blockage. If you need to remove the anti-clog cap to clean it, you **MUST** install it again before using the appliance. To install the anti-clog cap, put it on top of the prongs and press down until it snaps into place.

To Install: Position the anti-clog cap in place and push down.

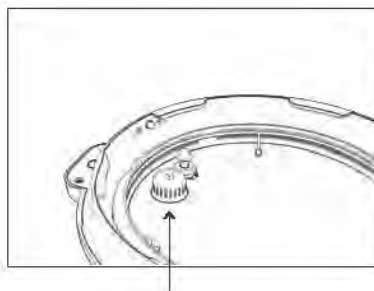
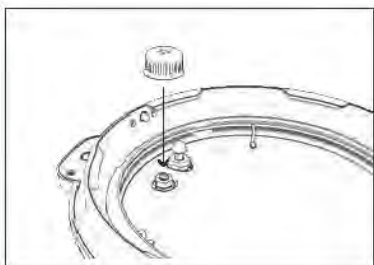

Properly Installed

Float Valve Pin

The float valve pin indicates whether the appliance is pressurized or not. The float valve pin comes pre-installed with the appliance.

When it **IS** pressurized, the valve pin will be visibly sticking out above the lid. When it is **NOT** pressurized, the valve will be flush to the lid or slightly lower.

The float valve pin and anti-clog cap work together to make sure pressure and steam are sealed inside the appliance. Both parts **MUST** be installed before use. Never operate the appliance without the float valve pin and anti-clog cap installed and never touch the float valve pin when the appliance is in use.

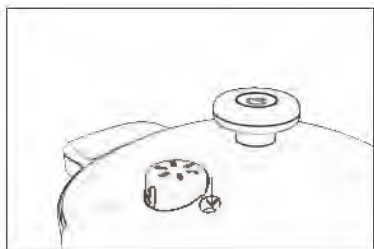

Depressurized: Float Valve Pin will be down

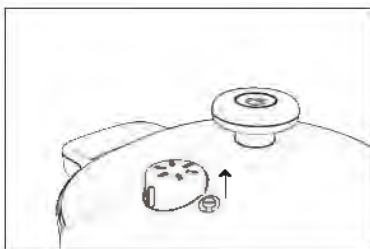

Pressurized: Float Valve Pin will be up and slightly flush with the lid

Silicone Sealing Ring

When the lid is closed, the silicone sealing ring (on the underside of the lid) creates an air-tight seal between the lid and the cooker base. The silicone sealing ring comes pre-installed with the appliance.

The silicone sealing ring must be installed before using the appliance and should be cleaned after each use. **NEVER** install more than one silicone sealing ring at a time.

The silicone sealing ring is reversible and can be inserted in either direction. Insert around the outer edge of the sealing ring holder on the underside of the lid. Ensure it is fully inserted and lies flat under the sealing ring holder.

It's normal for silicone sealing rings to stretch over time with use. To keep your appliance safe, replace the silicone sealing ring every 12 to 18 months. Replace sooner if you notice stretching, deformation, or damage. See page 31 for more information on replacement parts.



Silicone Sealing Ring

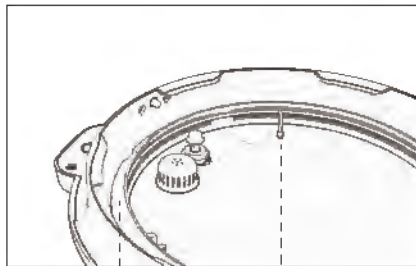

Silicone Sealing Ring

Sealing Ring Holder

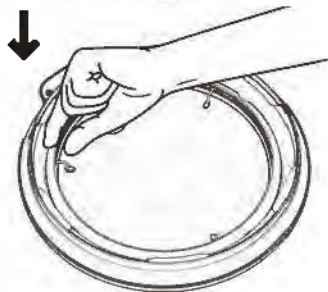
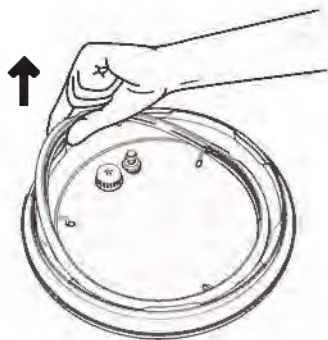

Condensation Collector

The condensation collector sits on the back of the appliance and collects any overflow of moisture. The condensation collector comes pre-installed with the appliance.

The condensation collector should be installed before cooking, then emptied and rinsed out after each use of the appliance. Be sure to empty it when full.

To remove, simply pull the condensation collector away (not down!) from the base of the appliance.

To install, line up the grooves on the condensation collector with the tabs on the base of the appliance, then slide into place like a drawer.

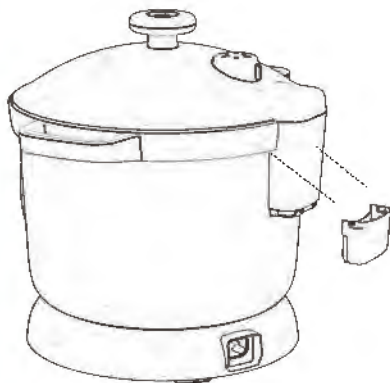

Not Installed



Installed

CONTROL PANEL

A, B & C



A. Timer: The timer will count down from the set cook time. Once cooking is complete, it will switch to Keep Warm, depending on your chosen cooking mode, and will begin counting up to a maximum of 8 hours.



B. Preheat: Preheat: “PrE” will appear on the control panel, and the Preheat Indicator icon  will be on, indicating the appliance is preheating.



C. Hold: During pressure release, “HOLD” and the Steam Release icon  will appear on the control panel. Wait until they have disappeared from the control panel and the float valve pin has dropped before removing the lid, indicating pressure has been released.

CONTROL PANEL



Icons:



D. The **Preheat Indicator** will be on during preheating when the Saute/Sear mode is selected, and during pressurizing when the Pressure Cook mode is selected.



E. The **Steam Release Indicator** will be on during steam-releasing when the Pressure Cook mode is being used.



F. The **Lid Warning Indicator** will be on if the lid is not closed properly or installed. Cooking will not begin until the lid is adjusted or installed correctly if using the Slow Cook or Pressure Cook modes. This icon will also appear if attempting to lock the lid while using the Saute/Sear cooking mode.



G. The **Inner Cooking Pot Warning Indicator** will turn on if no inner cooking pot has been inserted. Cooking will not begin until the inner cooking pot is inserted. "POT" will also appear on the Timer until the inner cooking pot has been inserted. This icon will also be on if the lid is not installed correctly.

CONTROL PANEL

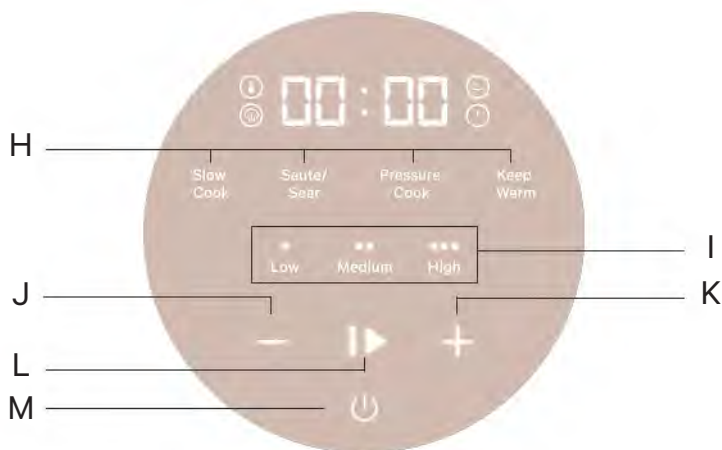

Controls:

H. Cooking Mode: Select from Slow Cook, Saute/Sear, Pressure Cook, or Keep Warm.

I. Temperature / Pressure: Select from Low, Medium or High temperature and pressure.

- J. Decreases the time setting.

+ K. Increases the time setting.



L. Start/Stop button: After selecting your cooking mode, temperature, and time, press to start cooking. Press again to stop cooking or before changing your settings.



M. On/Off button: Turns your appliance on and off.

BEFORE FIRST USE

1. Remove and discard any packaging material from the appliance.
2. Remove all components from the package and read this manual carefully. Please pay particular attention to operational instructions, warnings, and important safeguards to avoid any injury or property damage.
3. Wash the inner cooking pot, lid cover, and silicone sealing ring in hot, soapy water, then rinse and dry thoroughly. **NEVER** put the inner cooking pot, cooker base, or lid cover in the dishwasher.
4. Inspect the lid to ensure there is no debris blocking the steam release vent cover.
5. The silicone sealing ring is reversible and can be inserted in either direction. Insert the silicone sealing ring around the outer edge of the sealing ring holder on the underside of the lid. Ensure it is fully inserted and lies flat under the sealing ring holder, as shown on page 8.
6. Ensure the steam release anti-clog cap is installed. Place it over the prongs under the underside of the lid and press down until it snaps into position.
7. Ensure the vent cover is not clogged and is securely installed on the lid.
8. Ensure the float valve pin is installed properly, not clogged and is in proper working order.
9. Ensure the condensation collector is installed securely over the tabs on the back of the appliance base.
10. Place the appliance on a stable, level, heat-resistant surface. Keep away from areas that can be damaged by steam (such as walls or cupboards).
11. When using this appliance, provide adequate space (at least 5 inches above and at least 3 inches on all sides) for air circulation.
12. Ensure the inner cooking pot is in position and the lid is secured properly.
13. Plug the appliance into a kitchen outlet.

Note: The appliance may have a plastic smell during the first use. This is normal. If the plastic smell does not decrease after the first use, please contact Customer Support at hello@fromourplace.com.

INSTRUCTIONS FOR USE

NOTE: Prior to each use, make sure the silicone sealing ring is well-positioned in the sealing ring holder and the anti-clog cap is mounted properly on the steam release valve shield. Make sure the condensation collector and steam release vent cover are properly installed.

1. **Plug the appliance into a kitchen outlet. The On/Off button will activate.**
2. **Press the On/Off button to activate the control panel and turn to Standby mode.**
3. Select your desired cooking mode by pressing the Slow Cook, Saute/Sear, or Pressure Cook buttons, and then select Low, Medium, or High to choose your heat setting. You can also select Keep Warm – no temperature input is required.
4. Press the “-” (minus) and “+” (plus) buttons to adjust the cooking time lower and higher.
5. Press the Start/Stop button to begin cooking. A beep will sound signaling the unit is preheating.
6. During the cooking process, press the Start/Stop button to fully stop the cooking process, to pause the cooking process to adjust the temperature or time, or to change to another cooking mode.
7. Once the set cook time has been reached, the appliance will beep three times, signaling cooking has completed. It will then automatically switch to Keep Warm mode and the timer will begin counting up to 8 hours. You can stop this at any time by pressing the Start/Stop button.
8. You can also press the Keep Warm button immediately after turning on the appliance to keep food & liquids warm.
9. **To turn off the appliance, press and hold the On/Off button.**

Cook Time and Temperature Chart

Function	Temp Range	Time Range	Lid Status	Remark
Slow Cook	Low, Medium, High	00:30 – 12:00	Closed	Will turn to Keep Warm mode automatically once cooking is complete for up to 8 hours.
Pressure Cook	Low, Medium, High	00:01 – 02:00	Closed	
Saute/Sear	Low, Medium, High	00:01 – 01:00	Open	
Keep Warm	N/A	00:30 – 12:00	Open or Closed	Maximum time is 8 hours. Appliance will then auto shut-off .

Pressure Cook





Pressure cooking is the process of cooking food under pressurized steam and liquid in a sealed vessel. High pressure helps to limit boiling and create high temperatures, which cook foods faster than other cooking methods. This cooking mode is the recommended method for foods that are unlikely to overcook, such as soups and stews, or for foods you wish to cook quickly.

Pressure cooking requires the use of liquid to create the steam needed. We recommend 1.5 cups (12 oz. or 375mL) as the minimum. The liquids used for pressure cooking should be water-based (such as broth, stock, or soup) and not oil-based. If your recipe calls for dairy, we recommend adding that at the end of the cooking process since dairy can curdle under pressure.

Most foods cook under high pressure, which helps to break them down and cook faster. Foods that are sensitive to overcooking (like rice, pasta, and eggs) cook better with low pressure.

How to pressure cook

1. Add food and required liquid to the inner cooking pot and place in the cooker base.
2. Place the lid on the appliance and twist to lock.
3. **Press the On/Off button to turn to activate the control panel and turn to Standby mode. Select Pressure Cook as your desired cooking mode.**

4. Set the desired pressure.
5. Set the desired time.
6. Press the Start button.
7. A beep will sound signaling the appliance is preheating and pressurizing. "PrE" will appear on the control panel, and the Preheat Indicator icon  will be on.
 - a. If the lid is not properly secured, the word 'Lid' and the Lid Warning icon  will appear on the control panel and the appliance will beep. Adjust the lid and once locked, the beeping will stop and cooking will begin.
 - b. If the inner cooking pot has not been properly placed in the cooker base, the word 'Pot' and the Inner Cooking Pot Warning icon  will appear on the control panel and the appliance will beep. Once the inner cooking pot is properly installed, the beeping will stop.
8. Once the appliance has reached the set pressure and temperature, you will hear a beep, the "PrE" and the Preheat Indicator will disappear from the control panel, and the timer will begin counting down from the set time.
9. When the timer reaches 00:00, this indicates cooking has stopped. You will hear three beeps, indicating cooking is complete. "HOLD" will appear on the control panel, and the Steam Release icon  will be on. The appliance will then automatically switch to Keep Warm mode and pressure will begin to release naturally. The timer will begin counting up, indicating how long it has been in Keep Warm mode.
10. **To turn off the appliance, press and hold the On/Off button.**

Tip: Choose the steam release method that works for your recipe. See Pressure Release Options below.

How to Release Steam

Pressure Release Options:

Natural Steam Release

This appliance is designed to release steam automatically during the cook cycle.

- Steam will periodically be released automatically during cooking to maintain ideal pressure.
- At the end of the cooking cycle, steam will be released periodically for several minutes (15 minutes up to 1 hour).
- Once cooking is complete, "HOLD" will appear on the control panel, and the Steam Release icon  will be on. You will hear two beeps before each

steam release.

- Wait until “HOLD” and the Steam Release icon  have disappeared from the control panel and the float valve pin has dropped before removing the lid. The lid will unlock easily. **DO NOT** force open. Release steam manually if needed or allow additional time for steam to naturally release.
- The Keep Warm icon will not illuminate on the control panel until steam is fully released.

NOTE: Dense foods such as oatmeal and chili should utilize the natural steam release option.

Manual Steam Release

This appliance includes a manual steam release button on the lid.

- The manual steam release button can be pressed at the end of the cooking cycle to rapidly release steam.
- The manual steam release button can be used in addition to automatic steam release.
- When cooking foods like rice or pasta, it is recommended to use the manual steam release to rapidly release the pressure at the end of the cooking cycle to avoid overcooking food.

NOTE: Do not use the manual steam release button right away after cooking is complete. Food can come out of the steam release vent and clog the valve.



Pressure Cooking Caution

This appliance uses pressure to cook. Allow the appliance to release all excess pressure and steam through the steam release vent cover before opening the lid. **The pressure release indicator on the control panel will turn off, and the float valve pin will drop when all pressure has been released.** Opening the lid before pressure is released may result in burns, personal injury, and/or property damage. You **MUST USE** the inner cooking pot when cooking. **DO NOT** overfill the inner cooking pot. You **MUST USE** liquid when using the Pressure Cook mode.

ALWAYS keep hands and face clear of the steam release valve when pressure cooking as hot steam and water may be emitted during operation which can result in scalding. **NEVER** place your face or hands over the appliance when removing the lid.

NOTE: If the lid will not unlock, this indicates the appliance is still under

pressure. **DO NOT** force the lid open as any remaining pressure can be hazardous. Let the appliance naturally release pressure OR press the manual steam release button. Take care to avoid contact with the steam to avoid burns, personal injury, and/or property damage

NOTE: Even if “HOLD” has disappeared from the control panel indicating the lid can be removed, **ALWAYS** push the manual steam release button before opening the lid to make sure all pressure has been released.

Overfill During Pressure Cooking



- Overfilling may cause a risk of clogging the steam release valve and developing excess pressure.
- **DO NOT** overfill or exceed the maximum fill line. Overfilling may cause **personal injury or property damage or affect safe use of the appliance.** Foods such as apple sauce, cranberries, pearl barley, oatmeal and other cereals, split peas, noodles and pasta can foam, froth, and splatter when pressure cooked. **DO NOT** fill the inner cooking pot past the maximum fill line (designated as “PC MAX”) when cooking these foods.
- When pressure cooking foods that expand (such as dried vegetables, beans, grains, rice, etc.), **DO NOT** fill the pot more than halfway (designated as the “1/2” line on the inner cooking pot), or as otherwise instructed in a recipe.
- **DO NOT** place oversized foods that exceed the maximum fill line (PC MAX) into the inner cooking pot as they may cause risk of fire, personal injury, and/or property damage.

Saute/Sear

Use the Saute/Sear mode like you would use a skillet or saute pan on the stove. (Except you won't have another pot or pan to clean!). Searing (or browning meat) prior to slow cooking or pressure cooking helps develop and enhance flavors. We recommend setting the temperature to High while searing.

Sauteing veggies or infusing herbs and aromatics into broths before cooking is another great way to boost your recipes. We recommend setting the temperature to either Low or Medium while sauteing.

How to Saute/Sear:

1. Add food to the inner cooking pot and place in the cooker base.
2. Select the Saute/Sear mode.
3. Set the desired temperature.
4. Set the desired time.
5. Press the Start button.
 - a. If the inner cooking pot has not been properly placed in the cooker base, the word 'Pot' and the Inner Cooking Pot Warning icon  will appear on the control panel and the appliance will beep. Once the inner cooking pot is properly inserted, the beeping will stop.
6. A beep will sound signaling the appliance is preheating. "PrE" will appear on the control panel, and the Preheat Indicator icon  will be on.
7. Once the appliance has reached the set temperature, you will hear a beep, the "PrE" and the Preheat Indicator will disappear from the control panel, and the timer will begin counting down from the set time.
8. Once the timer has reached 00:00, this indicates the cooking has stopped. You will hear three beeps, indicating cooking is complete.
9. Remove food or select another cooking mode (if pressure cooking or slow cooking).
10. **To turn off the appliance, press and hold the On/Off button.**

NOTE: The appliance does not auto switch to Keep Warm on Saute/Sear mode.



Saute/Sear Cooking Caution



ALWAYS use silicone or wooden utensils in the inner cooking pot. **DO NOT** use metal utensils, as they will scratch the nonstick coating on the inner cooking pot.

DO NOT twist to lock the lid on the appliance when using Saute/Sear mode. Doing so will cause the lid icon to activate, and the appliance will beep and not cook. Always use high smoke point oils and avoid aerosol spray oils when using Saute/Sear mode.

Slow Cook

Slow cooking is a method used to cook foods slowly over a long period of time using low, steady and moist heat. With slow cooking, recipes that call for High temperature usually cook in 4 – 6 hours, while recipes that call for Low temperature usually cook in 8 – 10 hours.

How to slow cook:

1. Add food and required liquid to the inner cooking pot and place in the cooker base. Do not exceed the PC MAX fill line on the inner cooking pot.
2. Place the lid on the appliance and twist to lock.
3. **Press the On/Off button to activate the control panel and turn to Standby mode.** Select the Slow Cook mode as your desired cooking mode.
4. Set the desired temperature.
5. Set the desired time.
6. Press the Start button.
7. A beep will sound signaling the appliance is ready to operate.
 - a. If the lid is not properly secured, the Lid Warning icon  will appear on the control panel and the appliance will beep. Adjust the lid and once locked, the beeping will stop and cooking will begin.
 - b. If the inner cooking pot has not been properly placed in the cooker base, the word 'Pot' and the Inner Cooking Pot Warning icon  will appear on the control panel and the appliance will beep. Once the inner cooking pot is properly inserted, the beeping will stop.
8. The timer will begin counting down from the set time.
9. Once the timer reaches 00:00, you will hear three beeps, indicating cooking is complete.
10. The appliance will then automatically switch to Keep Warm mode, and the timer will begin counting up to a maximum of 8 hours.
11. **To turn off the appliance, press and hold the On/Off button.**

NOTE: If the lid is hard to remove, push the manual steam release button a few times until pressure releases.

Keep Warm

Keep Warm can be used as its own mode to keep foods warm or to reheat foods like soups, stew and warm beverages. When Keep Warm is used at the end of the cooking process, the timer will count up to a maximum of 8 hours.

Once 8 hours is reached, the appliance will automatically shut off.

How to Keep Warm (used as its own mode):

1. Add food to the inner cooking pot and place in the cooker base.
2. If desired, place the lid on the appliance and twist to lock. The lid is not required to use the Keep Warm mode.

3. Press the On/Off button to turn to activate the control panel and turn to Standby mode. Select the Keep Warm mode as your desired cooking mode.
4. Set the desired time.
5. Press the Start button
6. A beep will sound signaling the appliance is ready to operate.
 - a. If the inner cooking pot has not been properly placed in the cooker base, the word 'Pot' and the Inner Cooking Pot Warning icon (!) will appear on the control panel and the appliance will beep. Once the inner cooking pot is properly inserted, the beeping will stop.
7. The timer will begin counting down from the set time.
8. Once the timer has reached 00:00, you will hear three beeps indicating the **warming has stopped, and the appliance will automatically shut off.**
9. To turn off the appliance, press and hold the On/Off button.

CLEANING AND MAINTENANCE

1. Unplug the appliance from the wall outlet before cleaning and make sure it has cooled to room temperature.
2. **NEVER** put the cooker base in the dishwasher or immerse it in water or any other liquid. To clean the cooker base and control panel, wipe clean with a damp cloth.
3. The lid can be washed with water and dish soap. **DO NOT** wash the lid or any of its components in the dishwasher, and **DO NOT** take apart the steam release valve.
4. Wash the inner cooking pot in hot, soapy water, then rinse and dry thoroughly. **NEVER** put the inner cooking pot in the dishwasher.
5. Wash the silicone sealing ring in hot, soapy water, then rinse and dry thoroughly. **NEVER** put the sealing ring in the dishwasher.
 - a. Remove the sealing ring by pulling the edge of the silicone out of the sealing ring holder on the underside of the lid.
 - b. Replace the sealing ring by pressing it firmly into the sealing ring holder to prevent warping. The sealing ring should fit snugly inside the sealing ring holder and should not fall out when lifting the lid.
 - c. Make sure the sealing ring does not have any warping or tears. If the sealing ring is damaged, contact Customer Support at hello@fromourplace.com.
6. If food residue is stuck on the inner cooking pot, fill the pot with water and

allow to soak before cleaning. **DO NOT** use scouring pads. If scrubbing is necessary, use a non-abrasive cleaner or liquid dish soap with a nylon pad or brush.

7. Remove the condensation collector and hand wash with soap and water or place in the top rack of a dishwasher.
 - a. To remove the condensation collector, pull the condensation collector away (not down!) from the base of the appliance.
 - b. Keep level to avoid spilling any collected liquid.
8. Air dry all parts after each use and make sure they are dried thoroughly before storing.

NOTE: Ensure all the parts are in place before next use.



WARNING

DO NOT immerse the cooker base, power cord, or power plug in water or any other liquid as this may cause electrocution.

Troubleshooting

PROBLEM	POSSIBLE REASON	POSSIBLE SOLUTION
Smell and minimal smoke on initial use.	Packing material still present in cooker base.	Ensure all packing material has been removed in and around the appliance and wash parts thoroughly.
Difficulty with closing the lid.	Sealing ring not installed properly.	Position the sealing ring well, ensuring it is snug behind the sealing ring holder.
Difficulty with opening the lid.	Pressure exists inside the appliance.	Press the steam release button to reduce internal pressure. Wait for the float valve pin to drop down, indicating pressure is completely released. The Pressure Cook icon will turn off on the Control Panel once pressure is released, indicating the lid is safe to open.
	Contents in the inner cooking pot are still hot.	
Steam leaks from the side of the lid.	Sealing ring damaged.	Replace the sealing ring.
	Food debris attached to the sealing ring.	Clean the sealing ring.
There is an occasional clicking sound.	The bottom outside of the inner cooking pot may be wet.	Dry the exterior of the inner pot.
		Ensure heating element is dry before inserting inner cooking pot into cooker base.
	The pressure board may be switching when temperature is increasing inside the appliance.	This is normal. The clicking indicates the appliance's heating elements are naturally cycling.

Troubleshooting

PROBLEM	POSSIBLE REASON	POSSIBLE SOLUTION
The control panel does not illuminate after connecting the appliance to a power outlet.	The plug may not be fully connected to the appliance, or to the power outlet.	Make sure the plug is securely connected to the outlet. If the plug is damaged, contact Customer Support at hello@fromourplace.com .
	The outlet may not have power.	Try a different outlet.
	The appliance fuse may have blown.	Contact Customer Support at hello@fromourplace.com .
Error code "Pot" shows on the display.	Inner cooking pot is not inside the cooker base. Inner cooking pot is required for all functions.	Ensure the inner cooking pot is properly installed in the cooker base.
Error code "Lid" shows on the display.	The lid may not be completely sealed or is not installed on the appliance.	Remove the lid and replace the lid, and make sure it is securely installed on the cooker base.
	If Saute/Sear cooking function is selected, the lid should not be used.	Remove the lid with the "Saute/Sear" cooking function.
Error code "Er01" shows on the display.	Faulty temperature sensor.	Contact Customer Support at hello@fromourplace.com .
Error code "Er02" shows on the display.	Faulty pressure sensor.	Contact Customer Support at hello@fromourplace.com .

Replacement Parts

Scan this QR code for replacement parts. You can also find recipes, FAQs and more there, too.



Warranty

We stand by our products. We want you to have the best experience with your Dream Cooker, so our team is here to help. Please contact us at hello@fromour-place.com if you have any questions regarding our warranty program or need advice on using your product. Lagom Kitchen Company, d/b/a “Our Place” (“Our Place”, “we”, or “our”) offers a limited warranty for the Dream Cooker if purchased and used in the United States. This Limited Warranty is made solely by Our Place and no other person or entity and is offered on the terms and conditions set forth in this Limited Warranty, also available on www.fromour-place.com/warranty.

What does this warranty cover?

This warranty covers defects in materials and workmanship for the Dream Cooker when used normally in accordance with Our Place’s user manual.

What does this warranty not cover?

This warranty does not cover any damages due to:

- Use of the product not for regular household purposes;
- Misuse, abuse, or negligent handling;
- Failure to follow the user manual (e.g. use, warning, maintenance, and care instruction);
- Normal wear and tear;
- Modifications to the product or use with products or parts not approved by Our Place;
- Cosmetic changes, including stains and discolorations;
- Installation with an incorrect electric current, voltage, circuit breaker rating, extension cord, or power supply;
- Damages or defects caused by service or repair of the product performed by an unauthorized service provider;
- Loss or damage in transit after initial delivery; and
- Accidents or other actions beyond our reasonable control.

Who is covered by this warranty?

This limited warranty covers the original retail consumer purchaser of a covered product or a consumer that receives the product new and unused as a gift from the original retail purchaser. Coverage terminates if a covered consumer sells or otherwise transfers the product. This limited warranty applies only to products purchased directly from Our Place or an Our Place authorized retailer.

This limited warranty is not transferable.

How long does this warranty last?

The warranty period for the Dream Cooker is limited to one (1) year from the date of delivery to the purchaser.

How do you exercise your rights under the Limited Warranty program?

Please complete our Warranty Claim form available at fromourplace.com/pages/warranty to submit a claim for evaluation. Proof of purchase is required for all claims, including gifted products. As part of the investigation into the claim, we may require you to submit photos, answer questions about the product and your use of the product, and/or try recommended techniques to rectify the issue first.

If your claim is approved, Our Place will either repair, replace or refund the purchase price of the product, as determined by Our Place in its sole discretion. If your claim is approved, Our Place will either repair, replace or refund the purchase price of the product, as determined by Our Place in its sole discretion. If we require the defective item to be returned to us, we will pay for return shipping if the item is returned within the country of purchase for our non-appliance products. For appliances, you will be responsible for the costs incurred to mail the returned product to us, including any applicable accessories.

While we will strive to exchange your product for the same make, color and model as your original purchase, we cannot make any guarantees. If an Our Place product, component or product color has been discontinued at the time of repair or replacement or if Our Place determines, in its sole discretion, that such repair or replacement is not commercially practicable or cannot be timely made, Our Place reserves the right to repair or replace such product or product component with a product model or color that is similar but not exactly the same as the product or component model originally purchased. Replacement with the same color cannot be guaranteed. At its sole discretion, Our Place is entitled to replace each defective component individually, as opposed to the entire product, and some assembly may be required by you. For example, if you purchase the Dream Cooker and only one component is found defective, Our Place may, at its discretion, opt to replace either the defective component or the entire Dream Cooker. Our Place reserves the right to utilize comparable reconditioned, refurbished, repaired, or re-manufactured products or parts in the warranty repair or replacement process. Such products and parts will be comparable in function and performance to an original product or part. The original warranty period will remain and will not restart with this replacement item, regardless of the time remaining under the original warranty period.

Disclaimer of Implied Warranties

EXCEPT AS EXPRESSLY PROVIDED HEREIN AND TO THE EXTENT PERMITTED BY LAW, THIS WARRANTY AND THE REMEDIES SET FORTH ARE EXCLUSIVE AND IN LIEU OF ALL OTHER WARRANTIES, REMEDIES AND CONDITIONS, WHETHER ORAL, WRITTEN, STATUTORY, EXPRESS OR IMPLIED. OUR PLACE DISCLAIMS ALL STATUTORY AND IMPLIED WARRANTIES INCLUDING, WITHOUT LIMITATION, WARRANTIES OF MERCHANTABILITY AND FITNESS FOR A PARTICULAR PURPOSE, WORKMANSHIP, MERCHANTABILITY, MERCHANTABILITY, DURABILITY AND WARRANTIES AGAINST HIDDEN OR LATENT DEFECTS, TO THE MAXIMUM EXTENT PERMITTED BY LAW. IN SO FAR AS SUCH WARRANTIES CANNOT BE DISCLAIMED, OUR PLACE LIMITS THE DURATION AND REMEDIES OF SUCH WARRANTIES TO THE DURATION OF THIS EXPRESS WARRANTY AND, AT OUR PLACE'S OPTION, THE REPAIR OR REPLACEMENT SERVICES DESCRIBED HEREIN. SOME STATES DO NOT ALLOW LIMITATIONS ON HOW LONG AN IMPLIED WARRANTY (OR CONDITION) MAY LAST, SO THE LIMITATION DESCRIBED ABOVE MAY NOT APPLY TO YOU.

Limitation of Liability

THE REMEDIES DESCRIBED ABOVE ARE YOUR SOLE AND EXCLUSIVE REMEDIES AND OUR PLACE'S ENTIRE LIABILITY FOR ANY BREACH OF THIS WARRANTY. This warranty gives you specific legal rights, and you may also have other rights which vary from state to state, or country to country.

OUR PLACE'S LIABILITY WILL UNDER NO CIRCUMSTANCES EXCEED THE ACTUAL AMOUNT PAID BY YOU FOR THE DEFECTIVE PRODUCT. OUR PLACE WILL NOT UNDER ANY CIRCUMSTANCES BE LIABLE FOR ANY CONSEQUENTIAL, INCIDENTAL, SPECIAL OR PUNITIVE DAMAGES OR LOSSES ARISING OUT OF OR IN CONNECTION WITH THE USE OR PERFORMANCE OF THE PRODUCTS OR DAMAGES WITH RESPECT TO ANY ECONOMIC LOSS, PERSONAL INJURY, LOSS OF PROPERTY, LOSS OF REVENUES OR PROFITS, LOSS OF ENJOYMENT OR USE, COSTS OF REMOVAL, INSTALLATION OR OTHER INDIRECT, INCIDENTAL OR CONSEQUENTIAL DAMAGES OF ANY NATURE OR KIND. Some states do not allow the exclusion or limitation of incidental or consequential damages, so the preceding limitation or exclusion may not apply to you.

Scan this QR code for replacement parts.
You can also find recipes, FAQs and more there, too.



Our Place[®]

*Need help? We're always here at
hello@fromourplace.com*