

NARWAL™

User Manual

Narwal Freo X Plus Robot Vacuum and Mop

Model: YJCC018

Dear users:

Thank you for purchasing Narwal products. To access comprehensive support from Narwal, you are recommended to read carefully the manual and illustrations before using the product. Please keep the manual properly.

The manual may be updated from time to time based on product updates and user feedback. Please scan the QR code below to browse the official website and view the latest version.

In case of any problem in using the product, please contact Narwal after-sales customer service through the following ways:

Customer service email:

support@narwal.com(North America)

support.eu@global.narwal.com(Germany)

support.it@global.narwal.com(Italy)

support.jp@narwal.com(Japan)

support.fr@global.narwal.com(France)

support.kr@narwal.com(South Korea)

support.es@global.narwal.com(Spain)

*For other countries, please refer to the after-sales contact information provided by your local vendors

We wish you a pleasant experience!



Electronic user manual

電子取扱説明書

전자 설명서

Elektronisches Benutzerhandbuch

Manuale Utente Elettronico

Manual de usuario electrónico

Manuel d'utilisation électronique

Электронное руководство пользователя

คู่มืออิเล็กทรอนิกส์

Số tay điện tử

מדריך אלקטרוני

Elektronik Kilavuz

Instrukcja elektroniczna

CONTENTS

1. Product At a Glance	03
1.1 Check list	
1.2 Robot	
1.3 Base station	
1.4 Buttons and indicators	
2. Get Ready Before Use	08
3. How to Use	10
3.1 Organize the home environment	
3.2 Mapping	
3.3 Cleaning	
4. Parameters	13
7.1 Specifications	

1. Product at a Glance

1.1 Check list

Main parts

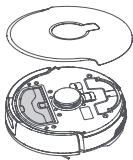

Robot ×1 (dust bin ×1,
water tank ×1, roller brush ×1,
mopping module ×1 included)

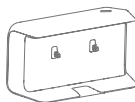

Base station ×1

Accessories

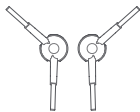

Side brush ×2

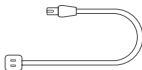

Power cord ×1



Moisture-proof pad ×1

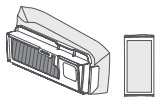

Disposable dust bag &
dust bag guardian ×2



Washable mop
pad ×1



Disposable mop pad ×2

1.2 Robot

Front (top cover closed)

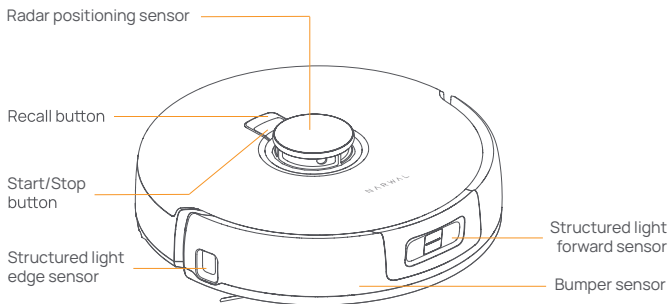

Front (top cover open)

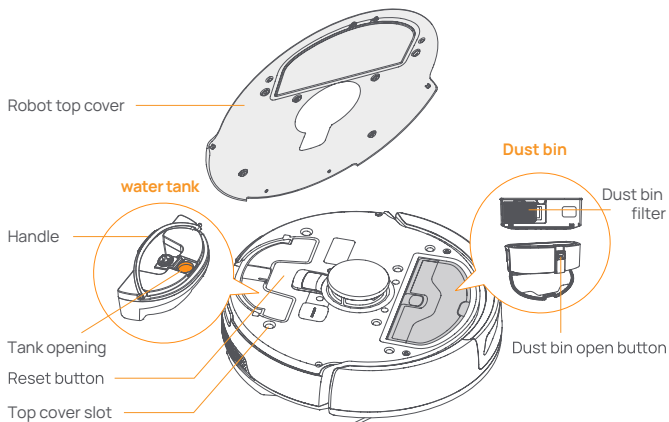

Robot bottom

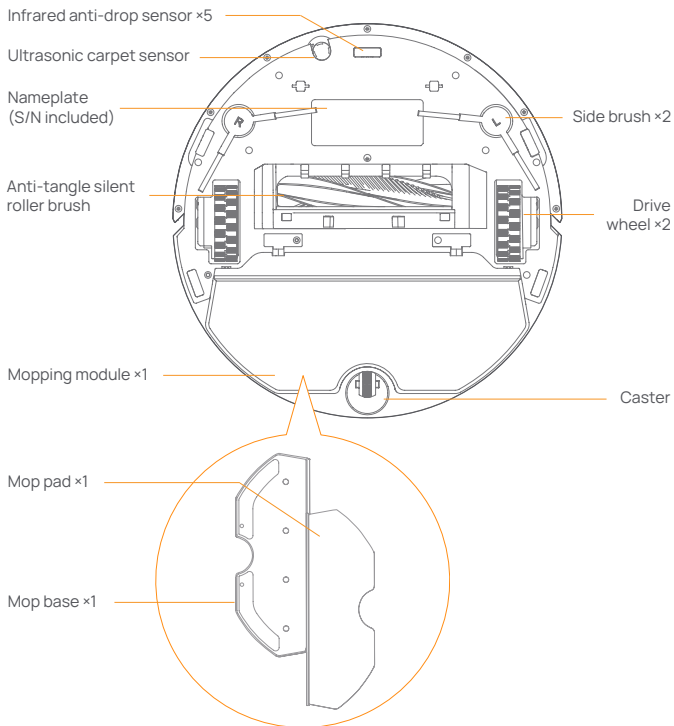

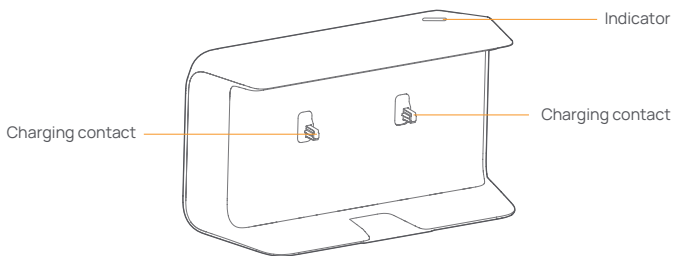
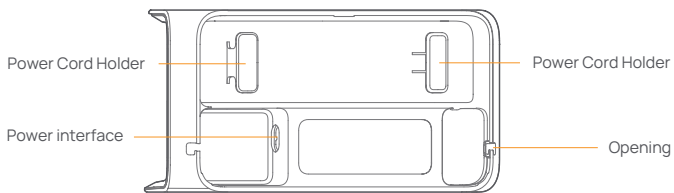

1.3 Base station



1.4 Robot buttons and indicators

Robot buttons

Button	Action	Function
Start/Stop 	Short press	Start/pause/resume current task
	Press and hold for 2s	Power on/off
Recall 	Short press	Return to the base station
	Press and hold for 2s	Child Lock on/off
Reset •	Short press	Enter the pairing mode
	Press and hold for 5s	Unbind the account and clear user data
	Press and hold for 10s	Restore factory settings

1) Robot indicators

Off	Breathing white	Steady blue
Shutdown or standby	Standby	Task underway
Breathing blue	Breathing orange	Flashing red
Task paused	Network configuring, updating or resetting	Error

2) Base station indicators

Off	Steady	Breathing	Flashing
Fully charged or base station disconnected	Not charging	Charging	Base station failure

2. Get Ready before Use

Install the side brushes

Press side brushes into the slots as indicated by color until they click into place.

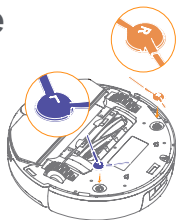

Remove the anti-collision foam

Open the robot top cover and remove the anti-collision foam.

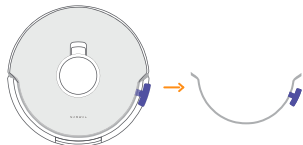

Place the base station

Plug in the power cord in the back of the base station. Put the base station on the flat and hard surface against the wall and leave an open space of at least 1.0m in front of the base station for the robot to enter and leave the base station.

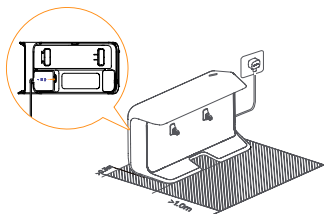

Fix the moisture-proof pad

Once the base station is put in place, wipe the indicated area clean with a dry cloth, peel off the double-sided tape on the back of the moisture-proof pad, and stick the map onto the floor as indicated.

Note:

1. The moisture-proof pad only applies to the wooden floor.
2. To remove the pad from the floor, please keep it slow to avoid residual glue.

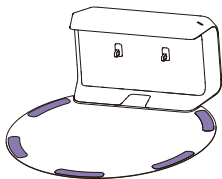

Add Water

Before mopping, add clean water to the water tank.

- Open the robot's top cover, remove the water tank. Fill the water tank with clean water through the tank opening.
- Close the tank, put it back into the robot, and place the robot's top cover back.

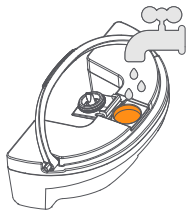

Boot settings

Push the robot into the base station and ensure the charging contacts are properly connected. The base station indicator goes out and the robot will turn itself on and broadcast a message.

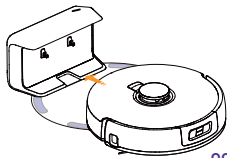

Connect and bind the robot in the App

Scan the QR code to download the Narwal App, tap "Add Device" and select the model in the App, and follow the instructions for connecting and binding the robot.

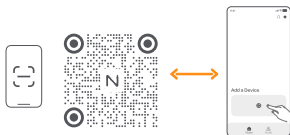

Note:

1. Tap "Settings" - "Device" in the App, then long press the "Restart Robot" for 10s to switch on/off the Standby Mode.

—Only available in the US market.

3. How to Use

Before using the robot, please make sure you have finished the installation and base station setup in Chapter 2.

3.1 Organize the home environment

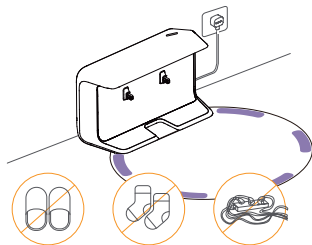

A. Put away the clutter on the floor, e.g. scattered cables, rags, slippers, clothes and books.

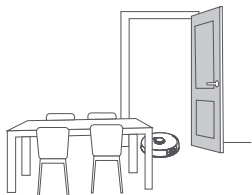

B. Open the doors of the rooms to be cleaned and arrange the furniture to leave as much space as possible for cleaning.

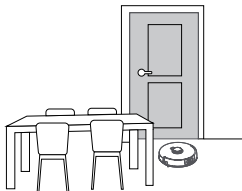

C. Leave other doors closed and install the fence to prevent the robot from entering elevated or low areas.

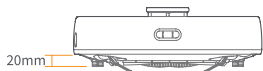

D. The maximum obstacle crossing height is 20mm and the robot cannot enter rooms with a threshold height of over 20mm. You can purchase Narwal Threshold Ramp to help the robot climb over and around obstacles more efficiently.



E. DO NOT stand in front of the robot, on the threshold or in narrow aisles to avoid omission.

3.2 Mapping

Before cleaning a new home, the robot needs to explore the environment and create a map. Before first-time cleaning, you can trigger mapping by short pressing the  **【Start/Stop】** button on the robot or tapping “Start Mapping” in the App.

Note:

1. Once a map is created, it can be edited in the App.
2. Please DO NOT move the base station after a map is created, or you have to restart mapping. If large furniture in your home is rearranged, it is recommended to create a new map.

3.3 Cleaning

Select cleaning modes

The product comes with four built-in cleaning modes: Vacuum, Mop, Vacuum and Mop, and Vacuum then Mop. You can select and adjust parameters like cleaning cycles, suction, and mop humidity for each mode in the App.

Set Freo Advise

Freo Advise is an intelligent cleaning assistant. When the Freo Advise mode is on, the robot can intelligently set cleaning parameters. You can enable Freo Advise after selecting the cleaning mode in the App.

Start cleaning task



You can start the robot for cleaning in the following two ways:

- Tap  **【Start Cleaning】** in the App
- Short press the  **【Start/Stop】** button on the robot and the robot will activate the Vacuum Mode by default;

Note: You can adjust the cleaning mode and set more cleaning parameters in the App.

Pause/resume current task

You can pause/resume the task in the following two ways:

- Tap  [Pause]/  [Resume] in the App;
- Short press the  [Start/Stop] button on the robot;

End current task

The robot will navigate itself back to the base station when cleaning ends. You can view the current cleaning report in the App.

You can manually end the task in the following two ways:

- Press and hold  [Finish] for 2s in the App;
- Short press the  Home [Recall] button on the robot;

4. Parameters

4.1 Specifications

Robot	Base station
Dimensions: 350*355*107 mm	Dimensions: 275*118*137 mm
Color: White	Color: White
Weight: ~4.25kg	Weight: ~0.86kg
Wi-Fi	Rated input: 100-240V~
Protocol: IEEE 802.11b/g/n	Rated output: 20V --- 1.8A
Frequency Range: 2412~2472MHz	Rated frequency: 50-60Hz
Max. Transmitter Power (EIRP): ≤20dBm	

Bluetooth (Rotbot)

Protocol: BLE 4.2

Frequency Range: 2402-2480MHz

Max. Transmitter Power (EIRP): $\leq 10\text{dBm}$

Battery (Rotbot)

Battery Type	Rechargeable Li-ion Battery
Battery Pack Quantity Per Pack	1 pcs
Quantity of Battery Cells Per Battery Pack	8 pcs
Rated Capacity, Rated Energy	5000mAh, 72Wh
Nominal Voltage	14.4V ---

Manufacturer: Yunjing Intelligence Innovation (Shenzhen) Co., Ltd.

Address: Room A2901, Yunzhongcheng, Building 1, Vanke Yuncheng VI, Dashi 2nd Road,
Xili Community, Xili Street, Nanshan District, Shenzhen, Guangdong, China



WWW.NARWAL.COM