

尺寸：105x148mm

材质：100g书纸

工艺：双面四色印刷 折页

Sablute

User Manual
Wireless Keyboard Combo

After-Sales
Email: sabluteservices@outlook.com
Website URL: sablute.com

KM25 Pro

system support: win11/win10/win8/win7/mac/ios/Android/windows xp...

Where is USB?

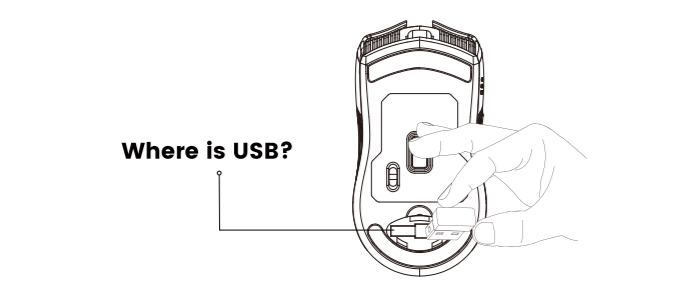

Take out the USB from the back of the mouse. The mouse and keyboard share one USB.

How to set up

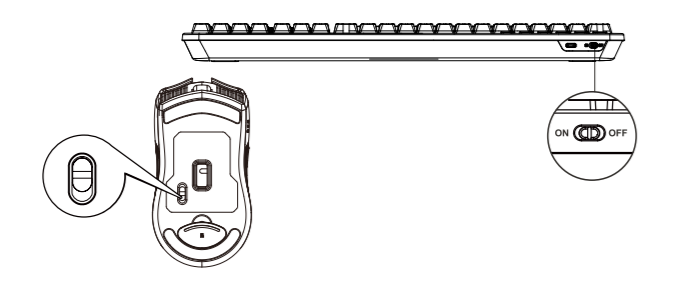

Step 1: Please put the USB receiver into your computer. Step 2: then turn on the keyboard and mouse. Note: The keyboard and mouse will automatically connect to the computer, no driver needed.

What to do if the keyboard loses connection with USB?

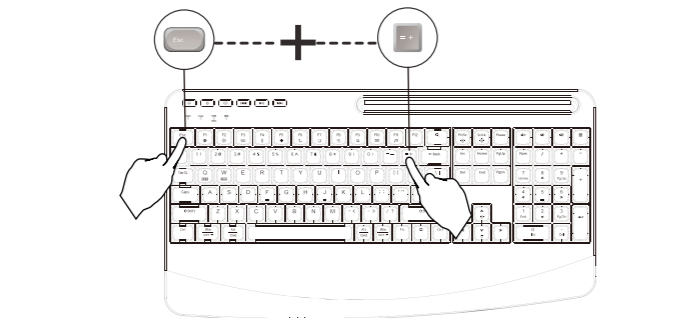

Pairing method: Long - press the "ESC" + "=" keys for three seconds until the red light flashes. Then, immediately plug in the receiver.

What to do if the mouse loses connection with USB?

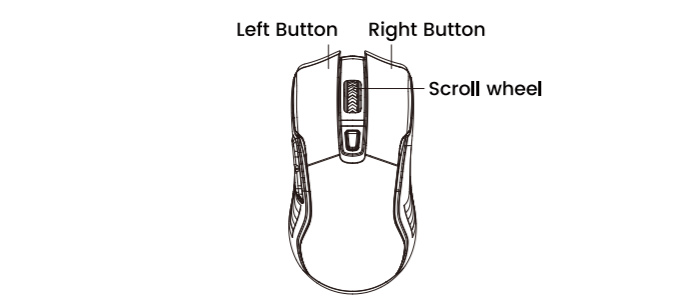

Press and hold the left, middle, and right buttons of the mouse for 3-5 seconds, then plug the USB into the computer.

The Functions of a Mouse

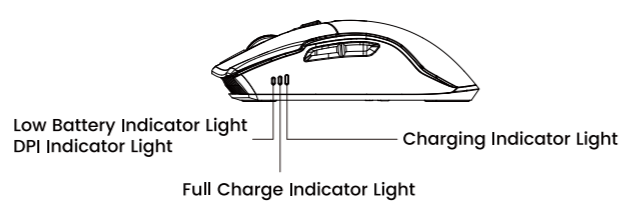
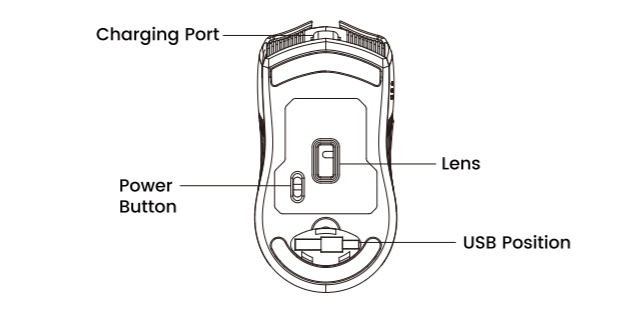
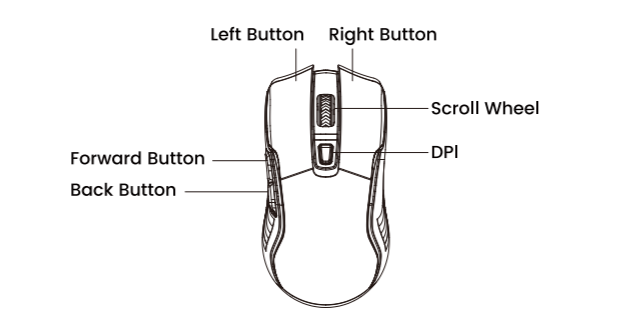

Shortcut keys

FN Key + Function Key	WIN FN+Q	MAC FN+W
[Sun icon]	Reduce the Screen Brightness	Reduce the Screen Brightness
[Sun icon]	Increase the Screen Brightness	Increase the Screen Brightness
[Window icon]	Window Switching	Window Switching
[Microphone icon]	Voice Assistant	Siri
[Globe icon]	Language Switch	Language Switch
[Moon icon]	Sleep	X
[Copy icon]	Copy	Copy
[Paste icon]	Paste	Paste
[Cut icon]	Cut	Cut
[Envelope icon]	Email	X
[Music icon]	Music	X
[Sun icon]	Keyboard backlight brightness improvement	Fn+Esc Keyboard backlight switch
[Moon icon]	Keyboard backlight brightness decreases	Fn+Scroll Keyboard backlight mode switching

Individual shortcut keys

[Screenshot icon]	Screenshot	Screenshot
[Emoji icon]	Emoji	X
[Lock icon]	Lock Screen	Lock Screen
[Previous Song icon]	Previous Song	Previous Song
[Play/Pause icon]	Play/Pause	Play/Pause
[Next Song icon]	Next Song	Next Song
[Mute icon]	Mute	Mute
[Volume - icon]	volume -	volume -
[Volume + icon]	volume +	volume +
[Calculator icon]	Calculator	X
[Search icon]	Search Function	Search Function

Keyboard lighting function

Num Lock: The Num Lock indicator will turn red when Num Lock is activated.

Caps Lock: The caps Lock indicator will turn red when caps Lock is activated.

Win:Fn+Q, Switch to the function of WIN system, and the red light stays on.

Mac:Fn+W, Switch to the function of Mac system, and the green light stays on.

Charging light: The red light remains on constantly when charging.

Keyboard specifications.

Keyboard:

Length:	428.77mm
Width:	229.3mm
Height:	33.75mm
Weight:	983g
Button Switch Life:	10 million times
Voltage:	3.7V
Battery Capacity:	4000mAh

Mouse:

Length:	127.2mm
Width:	66.7mm
Height:	38.6mm
Weight:	100g
Voltage:	3.7V

FAQ

- Q1:** How to fix keyboard delay or sticking?
A1:
- Check for 2.4GHz devices (e.g., router) nearby.
- Ensure the keyboard is fully charged.
- Remove any full-metal casing blocking the signal.
- Q2:** What to do if keyboard/mouse won't charge?
A2:
- Check charging port connection; replace the cable.
- Try a different USB port. Contact us if issue persists.
- Q3:** Backlight not working?
A3:
- Charge for 30 mins, then re-insert USB receiver.
- Restart keyboard and mouse.
- Q4:** Where's the USB receiver?
A4:
- It's under the mouse. Keyboard and mouse share one receiver.
- Q5:** How long do the keyboard and mouse last on a single charge?
A5:
-The keyboard can last about 50 hours with the backlight on, which is roughly one week of use, and up to four months without the backlight.
-The mouse lasts about 30 hours with the backlight on and around 100 hours without the backlight.

Customer service

Buy on SABLUTE, You will get:

- 30-Day Money-Back Guarantee
- 90-Day Free Replacement
- Hassle-Free Warranty Without Returning
- Lifetime Customer Support

Contact us

For FAQs and more information, please visit:

Phone: 1-888-858-1618 (US), Mon-Fri, 9am-6pm (Worktime), 1pm-2pm (Rest)



sablute.com/pages/contact
sabluteservices@outlook.com

FCC Statement

This equipment has been tested and complies with the limits for Class B digital devices under Part 15 of FCC rules, designed to protect residential environments from harmful interference. The device emits radio frequency energy during use, and improper installation as per instructions may cause interference with wireless communications. If interference is detected (testable by power cycling), please take the following actions:

1. Adjust the position of the receiving antenna.
2. Increase the distance between the device and the receiver.
3. Connect the device to a different circuit outlet than the receiver.
4. Consult a technician or dealer for assistance.

Modifications not approved by the compliance responsible party will void the authority to operate the equipment. Operation is subject to two conditions:

The device must not cause harmful interference.
The device must accept any interference received, including that affecting normal operation.