

User manual

 **Blueair**



SCAN FOR SUPPORT

**Scan now & register
your product!**

Additional warranty
information, contact
information, and FAQs are
there for you.

3-in-1 air purifier

T10i

T20i

Content

Please read this user manual carefully and keep it for future reference.

The latest version of this user manual can be found on www.blueair.com.

Safety information	3
3-in-1 air purifier	8
Product map	9
Getting started	10
Device controls	11
Air quality sensor	16
Filter replacement information	17
Maintenance information	19
Moving the device	20
Troubleshooting	21
Disposal, Support, and Warranty	23
Regulatory information	24



0111859000



IMPORTANT INSTRUCTIONS

3-in-1 air purifier is a multifunctional air purifier with built-in heating and a cooling fan function. Due to the heat source, some specific instructions related to the heat will follow.

HEATING SAFETY INSTRUCTION

- Read all instructions before using this heater.
- This heater is hot when in use. To avoid burns, do not let bare skin touch hot surfaces such as heating outlet or exhaust vent. Use the handles when moving this heater. Keep combustible materials, such as furniture, pillows, bedding, papers, clothes, and curtains at least 3 feet (0.9 m) from the heater.
- Extreme caution is necessary when any heater is used by or near children or individuals with reduced mental capacity or whenever the heater is left operating and unattended.
- Do not operate the heater if it has a damaged cord or plug, after heater malfunctions, or if it has been dropped or damaged in any manner.
- The heater will turn off automatically after 24 hours in use. Allow the device to cool down to room temperature before using the heating function again.
- Do not use outdoors.
- This heater is not intended for use in bathrooms, laundry areas and similar locations with high humidity and/or standing water. Never locate the heater where it may fall into a bathtub or other water containers.
- Do not run the cord under carpeting. Do not cover the cord with throw rugs, runners, or similar coverings. Do not route the cord under furniture or appliances. Arrange the cord away from traffic area and where it will not be tripped over.

- To disconnect the heater, turn the device off, then remove the plug from the outlet. Do not insert or allow foreign objects to enter any ventilation or exhaust opening as this may cause an electric shock or fire, or damage the heater.
- To prevent a possible fire, do not block the air intakes or exhaust in any manner. Do not use on soft surfaces, like a bed, where openings may become blocked.
- This heater has hot parts inside, which may if collected with dust or similar substance cause arcing or sparking. Do not use the heater in areas where gasoline, paint, or flammable liquids are used or stored.
- Use this heater only as described in this manual. Any other use not recommended by the manufacturer may cause fire, electric shock, or injury to persons.
- Always plug heaters directly into a wall outlet/receptacle. Never use with an extension cord or relocatable power tap (outlet/power strip).
- Hyperthermia can result in death. Symptoms of hyperthermia include high body temperature, headache, nausea, vomiting, tiredness, dizziness, fainting, and rapid pulse. If you begin to experience symptoms related to hyperthermia, turn off the heater and seek medical attention.
- Appliance should be placed only on the floor when in use.
- **SAVE THESE INSTRUCTIONS.**

Remote Battery Safety Instructions

- Remove and immediately recycle or dispose of used batteries according to local regulations and keep away from children. Do NOT dispose of batteries in household trash or incinerate.
- Even used batteries may cause severe injury or death.
- Call a local poison control center for treatment information.
- CR2025 button cell battery is compatible for this remote.
- Nominal battery voltage is 3V.

- Non-rechargeable batteries are not to be recharged.
- Do not force discharge, recharge, disassemble, heat above manufacturer's specified temperature rating or incinerate. Doing so may result in injury due to venting, leakage or explosion resulting in chemical burns.
- Ensure the batteries are installed correctly according to polarity (+ and -).
- Remove and immediately recycle or dispose of batteries from equipment not used for an extended period of time according to local regulations.
- Always completely secure the battery compartment. If the battery compartment does not close securely, stop using the product, remove the batteries, and keep them away from children.

⚠ WARNING

- **INGESTION HAZARD:** This product contains a button cell or coin battery.
- **DEATH** or serious injury can occur if ingested.
- A swallowed button cell or coin battery can cause **Internal Chemical Burns** in as little as **2 hours**
- **KEEP** new and used batteries **OUT OF REACH of CHILDREN**
- **Seek immediate medical attention** if a battery is suspected to be swallowed or inserted inside any part of the body.



General safety instructions

3-in-1 air purifier is an electrical appliance for indoor use only. Take the necessary precautions to reduce the risk of fire, electric shock or injury.

- This appliance is not intended for use by persons (including children) with reduced physical, sensory, or mental capabilities or lack of experience and knowledge, unless they have been given instructions concerning its use or are under supervision by a person responsible for their safety.

- Supervise children to ensure that they do not play with the appliance.
- Cleaning and product maintenance should not be conducted by children.
- Always disconnect the appliance from the power supply and allow it to cool to room temperature before maintenance.
- If your Blueair appliance is found to be defective, we will replace it with the same or a similar model at no cost, per the warranty terms. Please use caution attempting repairs yourself, as this presents the danger of electrical shock or injury.
- Ensure that the power cable and the power plug are not at risk of getting damaged.
- If the appliance is damaged or malfunctions, turn it off, disconnect it from the power supply and contact Blueair.
- The power plug must be firmly inserted in the power socket.
- When disconnecting the unit from the power supply, do not pull on the power cord, pull on the power plug.
- Use the power cable provided with your Blueair air purifier to plug directly and firmly into an appropriate, electrical outlet.
- To reduce risk of fire, electric shock or injury to persons, do not use replacement parts that have not been recommended by manufacturer (e.g. parts made at home using a 3D printer).
- Do not use an extension cord or a power strip. Refer to the rating label on your appliance.
- Do not alter the power plug in any way. If the plug does not fit into the outlet, contact qualified personnel to install the proper outlet.
- To avoid risk of fire or electric shock, the appliance should only be used with the correct input voltage that it is rated for, refer to your rating label on the device.
- Do not use the included power cord for anything else but the appliance.

- Do not allow objects to enter or block the air inlets and air outlets as this can cause electric shock or damage the appliance.
- Do not place any objects on top of or directly against the appliance.
- Do not sit on, stand, climb onto or hang from the appliance.
- Keep the appliance, including the power cable, at a safe distance from heated surfaces and open fire.
- Keep the appliance and power plug away from water and other liquids.
- Keep the appliance and power plug away from chemicals such as pesticides and deodorants.
- Always turn off and disconnect the appliance from the power supply before moving the unit, changing filters, cleaning or carrying out maintenance procedures.
- Never clean with gasoline, chemical solvents, or corrosive materials as these agents may damage the air purifier.
- This appliance has a polarized plug (one blade is wider than the other). To reduce the risk of electric shock, this plug is intended to fit in a polarized outlet only one way. If the plug does not fit fully in the outlet, reverse the plug. If it still does not fit, contact a qualified electrician. Do not attempt to defeat this safety feature.
- Do not operate the device with a damaged cord or plug.

WARNING: RISK OF ELECTRIC SHOCK.

3-in-1 air purifier

Product introduction

3-in-1 air purifier is a multifunctional air purifier with built-in heating and a cooling fan function. This product comes with integrated controls, built-in sensors, a digital display showing indoor pollution level (PM 2.5) and room temperature. To adjust the settings of your product, you can either use the control panel on top of the device, the remote control or the Blueair app. The Blueair app grants access to additional features and functions.

Recommendations for best performance

- Ensure that the size of the room where the air purifier is placed does not exceed the recommended capacity.
- Position the air purifier in an area where air can freely flow in and out, ensuring proper circulation.
- Maintain a distance of at least 4 inches (10 cm) between the air purifier and any other object to ensure proper air circulation.
- Keep the doors and windows closed while the air purifier is in operation.
- Clean the air quality sensor monthly to remove dust and other debris.
- Replace the filter when the Filter replacement indicator turns red on the control panel.
- To ensure smooth oscillation do not manually adjust the angle. Oscillation is automatically set and can reach 350 degrees.
- Refer to the maintenance instructions in this user manual for proper care.

The purpose of this device is to enhance your indoor air comfort by eliminating pollutants from the air while offering heating and cooling fan features.

Product map

Product name	Model number	Regulatory number
3-in-1 air purifier	T10i	4132411000
3-in-1 air purifier	T20i	4232412000

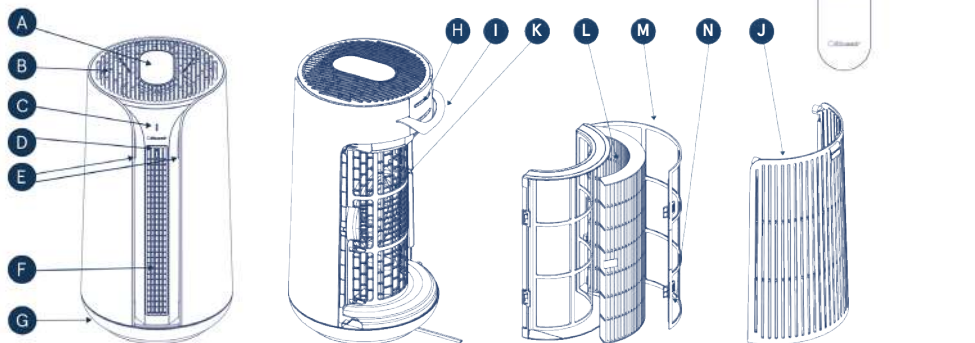

- A** Control panel & interface
- B** Boosted purification air outlet
- C** Air quality indicator (AQI)
- D** Mode indicator
- E** Cooling fan air outlets
- F** Heating air outlet
- G** Oscillation base

- H** Sensor module
- I** Handle (located on sides for T20i)
- J** Filter door
- K** Air inlets
- L** Filter
- M** Filter frame
- N** Pre-filter
- O** Remote

- Not pictured:
- Power cable
 - User manual
 - Remote holder (T20i only)

Getting started

Step 1

Open the filter door and take out the filter frame. Remove the plastic from the filter.

Step 2

Place the filter in the filter frame and put it back in the air purifier. Close the filter door.

Step 3

Plug the power cable into a grounded wall outlet.

Step 4

Press the On/Standby button to turn the air purifier on.

See section “Filter replacement information” for more information.

Connect to the Blueair app

Connecting to the Blueair app allows you to control the air purifier remotely and monitor filter usage. The app offers additional features to the device.

- Download the Blueair app from App Store or Google Play.
- Create or sign into your Blueair account.
- Click on **Connect Product+**.
- Follow the instructions to complete app pairing.



First time connecting tips

Turn on your air purifier. Press and hold the Auto button for 5 seconds to prepare the air purifier for pairing. Once the Wi-Fi indicator is blinking, it is ready to be paired with your app. Make sure you are using a visible Wi-Fi network. VPN (Virtual Private Network) should be deactivated while using the Blueair app.



Bluetooth is required for first time pairing. Turn your phone's bluetooth on and keep your phone within 3 feet (1 meter) of the air purifier for initial pairing.



This air purifier can only connect to 2.4 GHz Wi-Fi. If you are using a dual-band Wi-Fi router, make sure to select 2.4GHz.



Keep your air purifier within 15 feet (4,5 meters) of your Wi-Fi router when connecting the product for the first time.



Device controls

Control panel

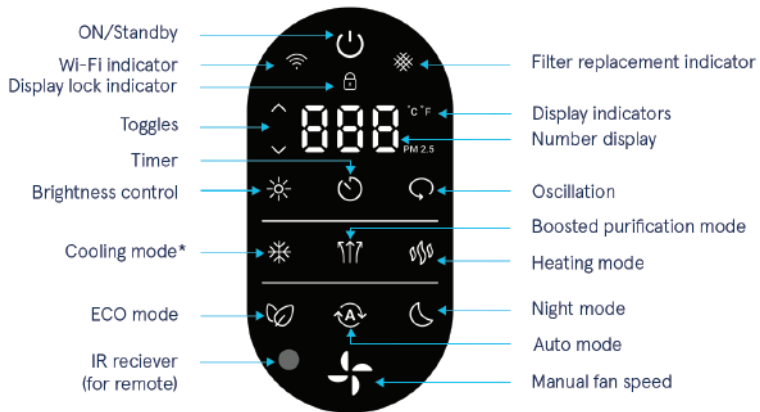



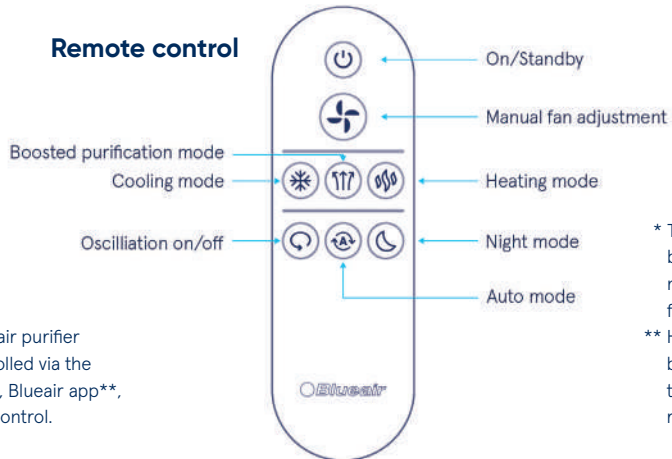







Remote control











Note! 3-in-1 air purifier can be controlled via the control panel, Blueair app**, and remote control.

* Temperature cannot be adjusted in Cooling mode. Cools through fan, not air conditioning.
** Heating mode cannot be activated through the app due to safety regulations.

Icon functionality

	On/Standby	Turn the device On or go into Standby mode.
Main modes		
	Cooling mode	Select Cooling to enjoy fan functionality. Adjust fan speed by pressing the Fan button. Default display will be room temperature reading in this mode. (Temperature cannot be adjusted as it is cooling through fan).  Pair it with Night mode to dim the brightness to lowest level.
	Boosted purification mode	Choose this mode for best purification performance. Airflow will be delivered upwards, and display shows PM 2.5 level. You can pair it with smart modes listed below.  ECO mode: (Only for Purification setting) Sets device on standby after it detects clean air for over 10 minutes. When air pollution increases device will turn back on.  Auto mode: The device will automatically adjust the fan speed based on your indoor PM 2.5 levels to ensure optimal air quality.  Night mode: Turns the device to the lowest fan speed and lowest brightness.
	Heating mode	Choose this mode to enjoy purified warm air. Oscillation is turned off by default. You can manually turn it on by clicking Oscillation button. Set a target heat temperature by pressing Heating button, wait for toggles flashing and click until it reaches the target.  Pair it with Auto mode , the device will work to achieve and maintain target heat temperature in your room.
	Brightness control	Press the Brightness icon and use Toggle buttons to adjust the display brightness. Use remote to turn on Heating and manually set target temperature on the UI. Once it's set up, the next time you turn on Heating via remote it will set to previous temperature.
	Timer	Timer can be set in any mode. Press the Timer icon, use the Toggles to select the number of hours, and press the Timer icon again to confirm. After the timer is set, press Timer button to view remaining time. When the timer finishes, the device will go into Standby mode.

	Oscillation	Click Oscillation button to turn on/off oscillation. Default oscillation angle on device and remote control is 180°. Personalize angle further in Blueair app.
	Wi-Fi indicator	An indicator that shows connection status. Blinking: Connecting (for initial use) or unstable network (once connected). Solid: Connected. Not lit: Not connected.
	Filter replacement indicator	When it turns red it means filter has expired. After replacing it with a new filter, always reset the Filter replacement indicator by pressing the Fan icon for 15 seconds. (See Filter replacement section.)
	Display lock indicator	Hold the On/Standby button for 5 seconds to activate/deactivate. The lit indicator means the display is locked, preventing remote or control panel operation.
	Toggles	Use the Toggle buttons to alternate what is shown in the Number display. The Toggle button allows you to adjust certain device settings, such as Brightness, Timer or Target Heat temperature.
	Display indicators	Use Toggle buttons to show either PM 2.5 level or room temperature. Indicates what is the numeric display.
	Number display	Display PM 2.5 levels in Boosted mode, room temperature in Cooling mode, and target heat temperature in Heating mode. Also indicates different setting levels for Timer and Brightness.
	Manual fan adjustment	Adjust the fan speed 1-2-3-4 manually.

Additional features on the control panel

Factory reset

Reset the device to the factory setting by pushing the On/Standby button for 15 seconds.

Switch between Fahrenheit and Celsius

3-in-1 air purifier can display degrees in both Fahrenheit and Celsius. The factory setting is adapted to the market in which the product is purchased. Change between the scales by pushing the Heating and Toggle buttons at the same time.

Quick option to turn off Timer and Wi-Fi

Press the Timer button for 5 seconds to turn the Timer off.

Press the Auto button for 5 seconds to turn the Wi-Fi off.

AQI indicator

The 3-in-1 air purifier has a particle sensor to measure the fine particle levels (PM 2.5) in the room. The AQI indicator displays the air quality status in five colors, from excellent (blue) to very polluted (red).

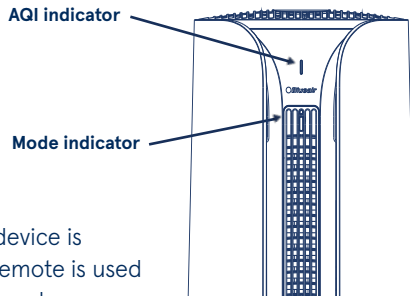

Mode indicator

The Mode indicator shows which main mode the device is currently in. The Mode indicator blinks when the remote is used to indicate that the device has received the command.



White:

Boosted purification mode



Orange:

Heating mode



Blue:

Cooling mode

Note! The Orange light for the Heating mode is a regulatory requirement and will not turn off even if the display brightness is set to 0% or if the device is in Night mode.

Air quality sensor

Important! Do not use your fingers or any other objects to clean inside the sensor inlets.

The inlets for the Air quality sensor are located at the back of the air purifier. Clean the inlets and the sensor when changing the filter.

Step 1

Turn the device off and unplug the cord.

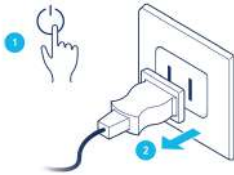

Step 2

Remove the filter door and open the sensor hatch to the Air quality sensor.

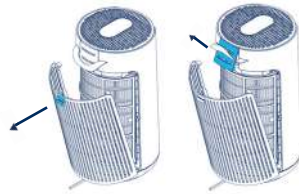

Step 3

Gently vacuum the inlets with a soft brush and clean the sensor with a cotton swab.



Step 4

Place the hatch back, close the filter door and plug in the cord.

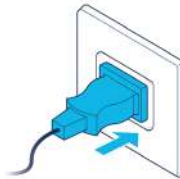

Filter replacement information

Changing the filter

Important! Always turn off and disconnect the appliance from the power supply and allow the device to cool to room temperature before changing filters, cleaning, or carrying out maintenance procedures.

The 3-in-1 air purifier calculates the remaining lifetime of the filter based on actual usage and indoor pollution levels. When it is time to change the filter, the filter replacement indicator will appear red on the control panel on top of the device. The recommended time for filter change is 6–9 months.



Filter replacement indicator

Using only original Blueair filters compatible with your device is recommended to ensure optimal performance. The serial number and model name can be found at the bottom of the device. Easily order from www.blueair.com or sign up to Blueair filter subscription.

Step 1

Open the filter door by pulling the flap at the top.

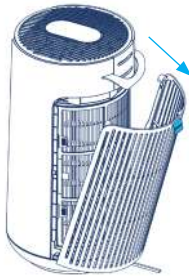

Step 2

Pull the filter frame straight out using the pull tab.

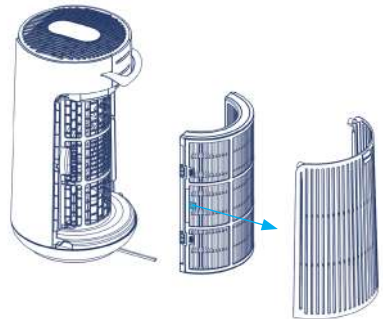

Step 3

Remove the old filter by pulling the two filter tabs.

Important! Make sure to remove the filter from the filter frame before discarding it. The filter frame should **not** be thrown away.

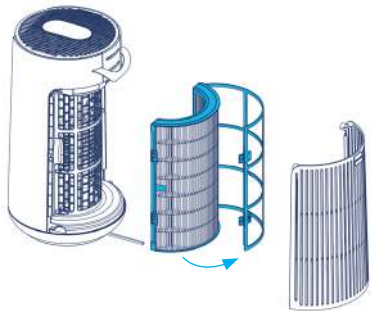

Step 4

Place the new filter inside the filter frame.

Important! Remove the plastic around the new filter.

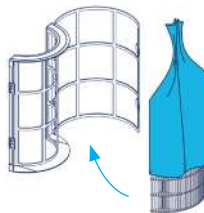

Step 5

Close the filter frame with the clasps. Put the filter frame back in the device and close the filter door.

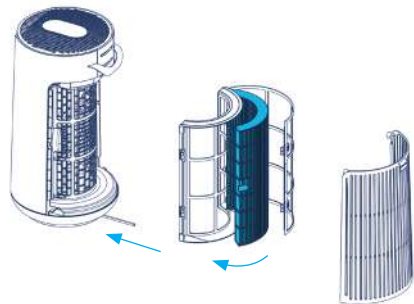

Step 6

To reset the Filter replacement indicator after changing the filter, push the Manual fan adjustment button for 15 seconds.



Maintenance information

To keep your air purifier in top condition regular maintenance is essential. Please follow these recommendations when cleaning your device.

General

- Disconnect the air purifier from the power supply and allow the device to cool to room temperature before maintenance.
- Do not allow foreign objects to enter the air inlets or air outlets. This may cause electric shock or damage the air purifier.
- Never clean with gasoline, chemical solvents or corrosive materials as these agents may damage the air purifier.
- Make sure the air purifier is completely dry before connecting it to a power supply.
- Do not wash the filter, it's not washable or reusable.

Cleaning

- Wipe the exterior of the air purifier with a soft, clean cloth.
- Open the filter door and clean the inside of the door with a soft, clean cloth.
- Vacuum the air inlets with a soft brush (not included).
- Vacuum the inside of the air purifier with a soft brush (not included).
- Clean and check the power cable and power plug for wear or damages.
- Clean the pre-filters with a soft cloth or vacuum on low setting with a soft brush (not included) once a week.
- Clean the Air quality sensor when changing the filter.

Moving the device

Important! Unplug the air purifier and allow it to cool to room temperature before moving it.

The 3-in-1 air purifier has a handle/handles that makes it easier to move. Follow the instructions when moving your device. Make sure that the filter door is securely closed.

3-in-1 air purifier model T10i

Step 1

Place your hand inside the handle at the back of the device and hold firmly.

Step 2

Lift the purifier straight up.

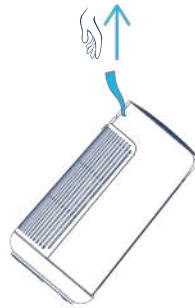

3-in-1 air purifier model T20i

Step 1

Grab the handles firmly and pull them out.

Step 2

Lift the device straight up using both hands.



Troubleshooting

Issue	Potential cause	Try this
There is a red hatch icon on my air purifier's panel.	It is time to change the filter.	<ol style="list-style-type: none">1. Change filter according to the instructions in this guide.2. Reset the Filter indicator by pressing the Manual fan adjustment button for 15 seconds, until the red light disappears.
My air purifier is making too much noise.	Air purifiers that are set on a high-speed level produce more noise because they function at faster rates.	Set a lower fan speed. The air purifier should be quieter.
	The plastic sealing is still on the filter.	Make sure that the plastic cover is removed from the filter.
	If the filter is too dirty and clogged the air purifier will not get sufficient airflow which may result in increased noise levels.	Unplug your air purifier and gently vacuum the back inlets. Replace the filter when the Filter replacement indicator turns red.
I cannot connect my air purifier.	The air purifier is too far from your phone and router during the setup.	<ol style="list-style-type: none">1. Ensure that your phone, air purifier and Wi-Fi router are in the same room and in close distance during initial set up, within 15 feet (5 meter). Once you have successfully paired your air purifier you can place it at your desired location.2. Make sure that your air purifier is plugged in and powered on.
	The Blueair app is not up to date.	Download the latest Blueair app version from the App store.
	The router is not on or has no connection. The router is not using a standard connection.	Ensure the following before trying to connect your product again: <ol style="list-style-type: none">1. Internet is currently running.2. You are using a 2.4 Ghz network.3. Deactivate VPN.
My air purifier has lost connection.	Bluetooth is deactivated.	Ensure Bluetooth is enabled in your smartphone's settings.
	Temporary Wi-Fi disturbances. New Wi-Fi settings or router.	If your air purifier does not re-connect by itself after a few minutes: <ol style="list-style-type: none">1. Open the Blueair app.2. Select your air purifier and go to Product settings.3. Delete the air purifier.4. Go back to the home screen and select "Connect Product". Follow the connection instructions.
My indoor air quality is not improving.	Indoor air quality remains polluted. Air quality sensors are dusty and showing incorrect levels.	<ol style="list-style-type: none">1. Unplug the air purifier and wait for approximately 30 seconds.2. Make sure that there are no objects or dust around the Air quality inlets at the back of the air purifier.3. Reconnect the power cable.4. Press the On/Standby button. If the air quality does not improve with the use of the air purifier and ventilation, please contact us at www.blueair.com .

Issue	Potential cause	Try this
There is a red light even when I put the brightness setting to 0 %.	When in Heating mode, the red light in the front of the device is a regulatory requirement and will not shut off even when brightness level is 0 %.	Change to another mode (Cooling or Boosted purification).
There is a draft coming from the front of the device when the device is set on Boosted purification mode.	In Boosted purification mode the heating air outlets in the front are still open, enabling some air to go out this way.	Set a lower fan speed.
The temperature in my room is not changing.	Room size is too big. When in cooling mode, it cools through fan with clean air at room temperature, not an air conditioning unit.	<ol style="list-style-type: none"> 1. Make sure it's the right sized room. 2. Change to higher fan speeds.
There is no power to my device, my device turns off on its own, my heater won't turn on.	Brightness set to 0. Timer ran out. Room temperature below 32°F / 0°C.	<ol style="list-style-type: none"> 1. Change to the right mode. 2. Use heating mode for room temperature above 32°F / 0°C.
My device will not oscillate.	ECO mode turned on. The automatic oscillation was manually pushed before.	Restart your device and change to non-eco mode.
There is no warm air from the device when it's on Heating mode.	<p>Room temperature is above target heat setting's upper limit (98°F/37°C).</p> <p>The device might be triggered "over-heating protection" to protect you from unsafe use cases (e.g., keeping Heating mode on over 24 hours; heating outlet is covered by clothes etc.; device is leaned on other objects or on the floor).</p>	<ol style="list-style-type: none"> 1. Set the target heat temperature above your room temperature. 2. Check if your device is already switched to Boosted Purification mode (after Heating mode runs over 24 hours). 3. Make sure the heating outlet is not covered and is facing an open space. 4. If none of above works, please contact customer service.

For more information and troubleshooting tips, please check the support page on www.blueair.com

Disposal, support and warranty

Disposal and recycling

The 3-in-1 air purifier should be disposed or recycled as electrical waste and the filter should be disposed as regular waste. If you have questions regarding the disposal and recycling of your device, please contact your local recycling facility or your Blueair retailer.

Help and support

If you have questions about your product, please visit www.blueair.com or contact your local Blueair retailer.

Limited warranty information

The 3-in-1 air purifier has a limited warranty of 3 years.



Regulatory information

Note! This equipment has been tested and found to comply with the limits for a Class B digital device, pursuant to Part 15 of the FCC Rules. These limits are designed to provide reasonable protection against harmful interference in a residential installation. This equipment generates, uses and can radiate radio frequency energy and, if not installed and used in accordance with the instructions, may cause harmful interference to radio communications.

However, there is no guarantee that interference will not occur in a particular installation. If this equipment does cause harmful interference to radio or television reception, which can be determined by turning the equipment off and on, the user is encouraged to try to correct the interference by one or more of the following measures:

- Reorient or relocate the receiving antenna.
- Increase the separation between the equipment and receiver.
- Connect the equipment into an outlet on a circuit different from that to which the receiver is connected.
- Consult the dealer or an experienced radio/TV technician for help.

This device complies with Part 15 of the FCC Rules. Operation is subject to the following two conditions:

- This device may not cause harmful interference.
- This device must accept any interference received, including interference that may cause undesired operation.

This Class B digital apparatus complies with Canadian ICES-003.

This device contains licence-exempt transmitter(s)/receiver(s) that comply with Innovation, Science and Economic Development Canada's license-exempt RSS(s). Operation is subject to the following two conditions: (1) This device may not cause interference, and (2) This device must accept any interference, including interference that may cause undesired operation of the device.

FCC/ISED RF Exposure Information: This equipment should be installed and operated with a minimum distance of 4 inches (10 cm) between the radiator and your body.