



WINBOT **MINI**

Instruction Manual

Important Safety Instructions

When using an electrical appliance, basic precautions should always be followed, including the following:

READ ALL INSTRUCTIONS BEFORE USING THIS APPLIANCE. SAVE THESE INSTRUCTIONS

1. This appliance can be used by persons with reduced physical, sensory or mental capabilities or lack of experience and knowledge if they have been given supervision or instruction concerning use of the appliance in a safe way and understand the hazards involved. Children shall not play with the appliance. The appliance is not to be used if it has been dropped, if there are visible signs of damage or if it is leaking. Keep the appliance out of reach of children when it is energized.
2. Do not use and charge the Appliance in extremely hot or cold environments (below 0°C/32°F or above 40°C/104°F, above 85% humidity), or it may affect battery life span.
3. The Appliance can be used to clean exterior windows if it is properly tethered to a safe position with the Carabiner, winds are calm, and it is not raining or snowing.
4. Before use, please use the Carabiner to lock the safety tether to a strong indoor railing, and make sure WINBOT is securely attached to it.
5. Do not leave the Appliance unattended when using it. To prevent bodily injury or property damage caused by accidental falling of the Appliance, please make sure there are no people, animals, or valuable, fragile objects under the working area of WINBOT.
6. Do not use the Appliance in whole gale storms and force-10 winds, or in areas where the altitude exceeds 2000 meters (6562 feet).
7. Please ensure the Appliance is plugged in while it is cleaning. The Appliance has a Safety Battery that charges during use. The Safety Battery powers the Appliance if it becomes unplugged or the electricity fails.
8. Do not leave the Appliance unattended when it is plugged in.
9. For household use ONLY (including exterior window). Do not use the Appliance in commercial or industrial environments.
10. Do not use on broken or uneven glass, such as glass with static cling stickers, advertising posters, or raised patterns, so as to prevent glass breaking or Appliance's falling. Do not







use on surfaces with gaps, such as a piece of glass with gaps or holes, or two pieces of adjacent, frameless glass with a gap between them, so as to prevent the Appliance from falling due to poor attachment.

11. Only use accessories recommended or supplied by the manufacturer. Only use the Power Adapter supplied by the manufacturer.
12. Please make sure your power supply voltage matches the power voltage marked on the Power Adapter.
13. Do not use the Appliance on a framed glass with a frame smaller than 5 mm (0.2 in).
14. Do not use on glass less than 3 mm (0.12 in) thick or mirrors less than 4 mm (0.16 in) thick.
15. Do not use on glass or mirrors with a handle height of 70~105 mm (2.76~ 4.13 in).
16. Do not use the Appliance on greasy windows.
17. When used in high humidity environment, the cleaning performance will be affected.
18. Store the Appliance away from heat and flammable materials.
19. In rainy weather, do not use the Appliance on the exterior window to avoid the risk of Appliance's damage or falling.
20. Do not use the Appliance if it does not firmly attach to the glass or has visible signs of damage.
21. To reduce the risk of electrical shock, do not put the Appliance in water or other liquid. Do not place or store Appliance where it can fall or be pulled into a tub or sink.
22. Do not touch power plug with wet hands.
23. When charging the Appliance, do not place it on other electrical appliances and keep it away from fire and liquid.
24. Take care not to damage the power cord. Do not pull on or carry the Appliance by the power cord, use the power cord as a handle, close a window on the power cord, or put heavy weights on the power cord. Keep power cord away from hot surfaces.
25. Do not use with a damaged power cord or receptacle. Do not use the Appliance if it is not working properly, has been dropped, damaged, or come in contact with water. It must be repaired by the manufacturer or its service agent in order to avoid a hazard.
26. If the supply cord is damaged, it must be replaced by the manufacturer or its service agent in order to avoid a hazard.
27. The plug must be removed from the receptacle before cleaning or maintaining the Appliance. Do not unplug the Power Adapter by pulling on the power cord.

28. The Safety Battery must be replaced by the manufacturer or its service agent in order to avoid a hazard.
29. The Safety Battery must be removed and discarded according to local laws and regulations before disposal of the Appliance.
30. The Appliance must be disconnected from the receptacle before removing the battery for disposal of the Appliance.
31. Please dispose of used batteries according to local laws and regulations.
32. Do not incinerate the Appliance even if it is severely damaged. The battery can explode in a fire.
33. The Appliance must be used in accordance with the directions in this Instruction Manual. The company cannot be held liable or responsible for any damages or injuries caused by improper use.
- 34. WARNING:** For the purposes of recharging the battery, only use the detachable supply unit GM95-240375-D provided with this Appliance.
35. The robot contains batteries that are only replaceable by skilled persons.
36. The plug and the Power Adapter must be used indoor.
37. If the vacuum glass, which WINBOT is working on, is leaking, remove WINBOT immediately after cleaning is completed.
38. Before cleaning, please observe the area to attach WINBOT for any small particles. If there are any, please remove them or switch to a particle-free area to avoid scratching the glass.
39. Clean the Mopping Pad in time and make sure that any small particles on it are completely removed to avoid scratching the glass.
40. The appliance is only to be used with the unit provided.
41. Keep the appliance out of reach of children when it is energized or cooling down.
42. The appliance has to be unplugged after use and before carrying out user maintenance on the appliance.

To satisfy RF exposure requirements, a separation distance of 20 cm or more should be maintained between this device and persons during device operation.

To ensure compliance, operations at closer than this distance is not recommended. The antenna used for this transmitter must not be co-located in conjunction with any other antenna or transmitter.

	Class II
	Short-circuit-proof safety isolating transformer
	Switch mode power supply
	For indoor use only
	Direct current
	Alternating current

For EU Countries

For EU Declaration of Conformity information, visit <https://www.ecovacs.com/global/compliance>



Correct Disposal of this Product

This marking indicates that this product should not be disposed of with other household waste throughout the EU. To prevent possible harm to the environment or human health from uncontrolled waste disposal, recycle it responsibly to promote the sustainable reuse of material resources. To recycle your used device, please use the return and collection systems or contact the retailer where the product was purchased. They can safely recycle this product.

1. Product Contents

Package Contents

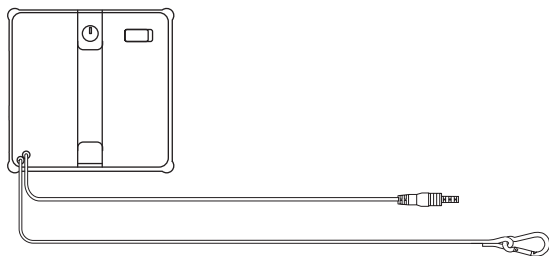

WINBOT + Safety Rope

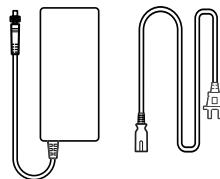

Power Adapter + Power Cord

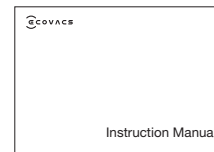

Instruction Manual



ECOVACS WINBOT Cleaning Solution

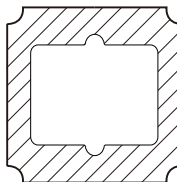

Mopping Pad

* Figures and illustrations are for reference only and may differ from actual product appearance.

Product Diagram

WINBOT

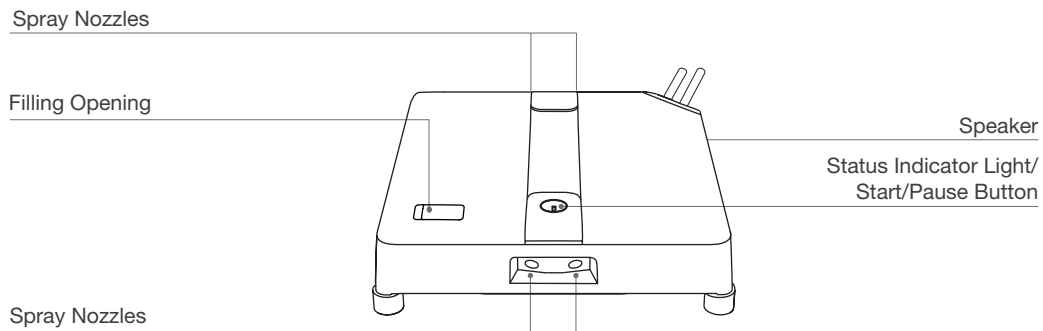

Bottom View

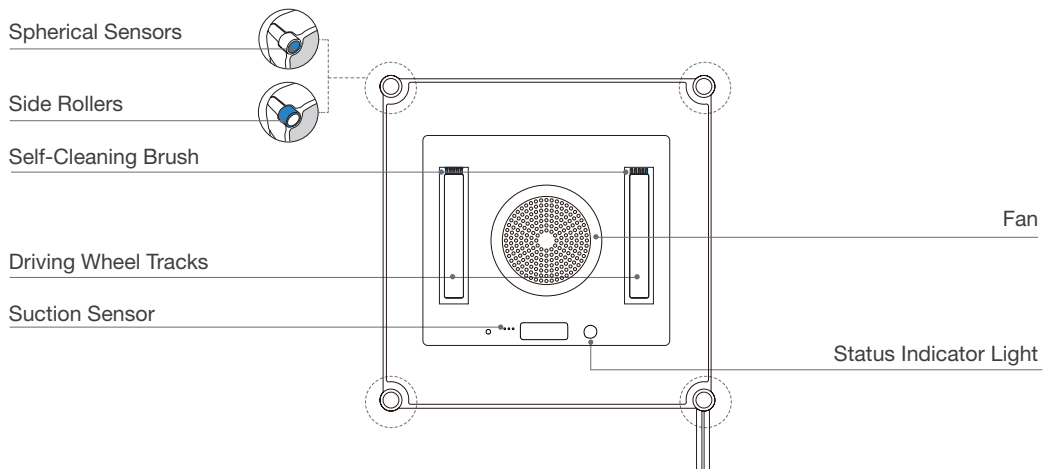

2. Quick Start

2.1 Notes Before Cleaning

The following situations are not recommended for using WINBOT:

- 1 Do not use WINBOT on windows with condensation or oil stains or in extremely cold or hot environments.

WINBOT may have difficulty moving in the following conditions.

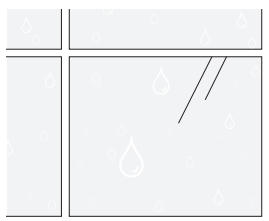

Condensation

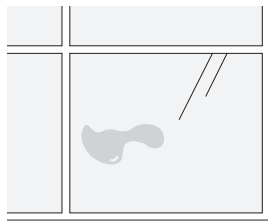

Oil stains

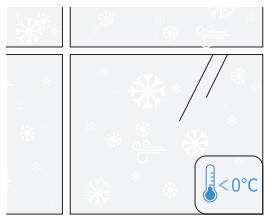

Below 0°C

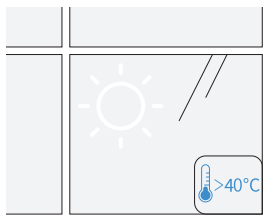

Above 40°C

 WINBOT delivers optimal performance on dry surfaces and in temperatures above 0°C .

- 2 Do not use WINBOT on windows that are too small or have irregular shapes.

WINBOT cannot move around in the following conditions.

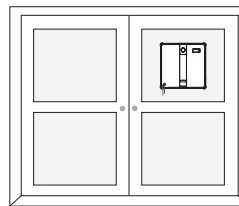

Small Glass

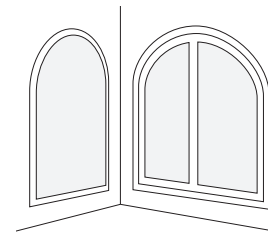

Irregular Shapes

 WINBOT delivers optimal performance on square and large windows.

3 Do not use WINBOT on uneven windows.

WINBOT may experience insufficient air pressure in the following conditions.

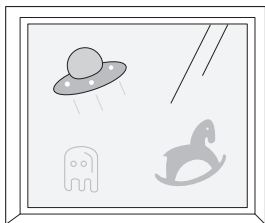

Electrostatic Window Decals, Stickers, etc.

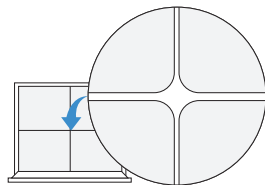

Cracks

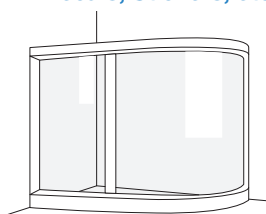

Arched Windows

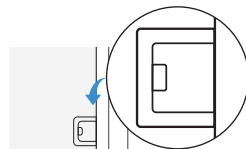

The height of obstacles is less than 4 mm.

Height of Frames < 3 mm

The height of frames is less than 3 mm.

4 Do not use WINBOT on windows that are too large.

WINBOT may fail to complete the task due to the length limitation of the connecting cord.

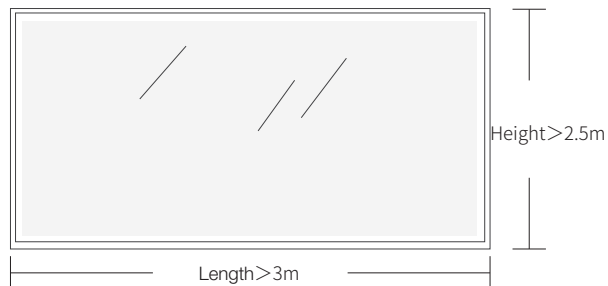

 WINBOT delivers optimal performance on a smooth window surface.

Make sure safety rope is connected before use.

Safety rope is assembled by default. Do not disassemble it at will.

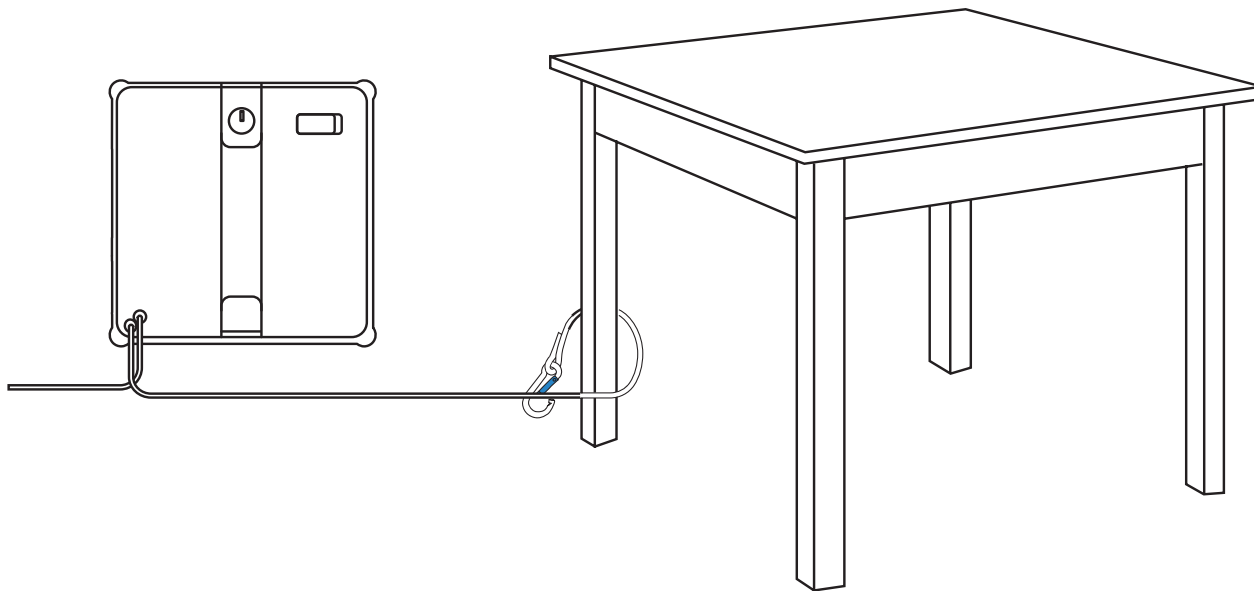

2.2 Preparation before Use

1 Install Mopping Pad

1. Wet the mopping pad

Before using, wet the mopping pad.



2. Twist the mopping pad

Twist the mopping pad to wring water out. To ensure cleaning performance, wring it out as much as you can.

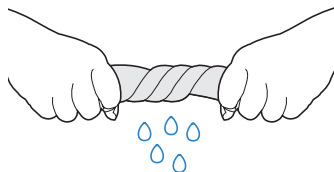

3. Stick the mopping pad

Stick the mopping pad onto the velcro at the bottom of WINBOT, with its groove corresponding to the blue mark. Then press it with your hands to help the mopping pad stick firmly.

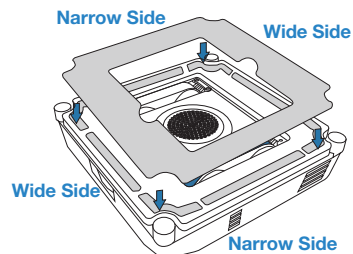
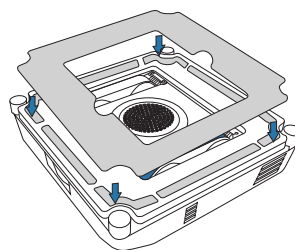

2 Fill up the Water Tank

It is recommended to use with ECOVACS WINBOT cleaning solution. The maximum volume of the reservoir is about 60ml. In the fast cleaning mode, the full water tank can spray water continuously for about 20 m².

Do not add too much cleaning solution to overflow the reservoir.

Do not add purified water and filtered water.

Please use ECOVACS WINBOT cleaning solution. Using other cleaners could have an adverse effect on cleaning performance.

If the cleaning solution is used up, you can temporarily use tap water instead. Using the ECOVACS WINBOT cleaning solution can have a better cleaning performance.

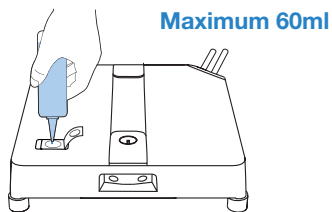

Note:

1. Do not put your fingers into the filling opening.

2. Wipe the water droplets on the body and the four spray outlets clean, so as not to affect the normal operation.

3 Tie the Safety Rope

Properly tie the safety rope to a stable object that cannot be easily moved (e.g. table leg, chair leg, bed leg, sofa leg, curtain rod, stair handrail, etc.), and lock the carabiner as shown below.

Note: Please make sure to use under supervision.

People or animals are prohibited from standing directly under WINBOT working area. Make sure there are no valuable or fragile objects under this area.

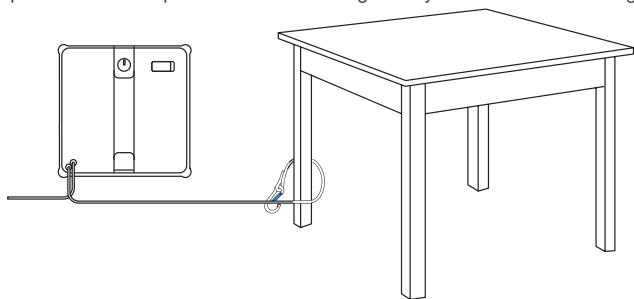

To ensure safety, please make sure to secure the carabiner before use.

* It is recommended to fasten the safety rope with the carabiner on a firm and safe metal railing.

4 Connect WINBOT Power Cord, Power Adapter and Plug.

Please ensure the battery is fully charged before using. Charging time will be approximately 3 hours.

- * Do not cut the power off when WINBOT is running, otherwise it may lead to the risk of falling.
- * It is particularly emphasized that the aviation plug needs to be firmly connected.

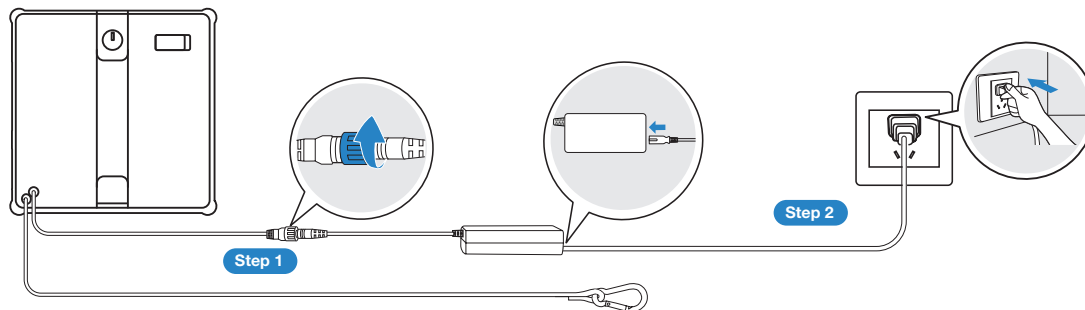

Connect correctly in the order shown above. Improper connection may cause charging abnormalities or damage to the battery.

2.3 Quick Start

1 Start

1. Connect the power supply and long press the WINBOT start button for 2 seconds.
2. After hearing the fan start, place the bottom of the WINBOT (the side with the mopping pad) on the glass. WINBOT will adhere to the window automatically and start cleaning.

- * Do not stick the WINBOT too close to the edge when cleaning the frameless glass. It is recommended to be more than 10cm away from the edge.
- * WINBOT can only clean flat surfaces. Please make sure that the glass thickness is not less than 3mm.
- * Do not put the fan close to hair and other small objects after power on, so as not to block the fan.
- * Before cleaning, please observe the area to attach WINBOT for any small particles. If there are any, please remove them or switch to a particle-free area to avoid scratching the glass.
- * Please dry the water droplets at the spray outlet before cleaning.

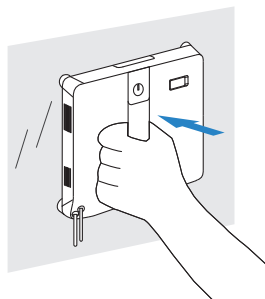
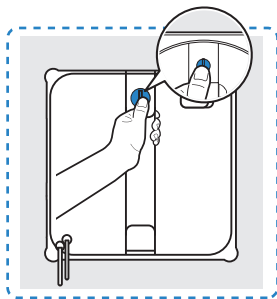

2 Maintenance during Cleaning

For heavily stained glass, please wash or replace the mopping pad several times and clean the four spherical sensors in time.

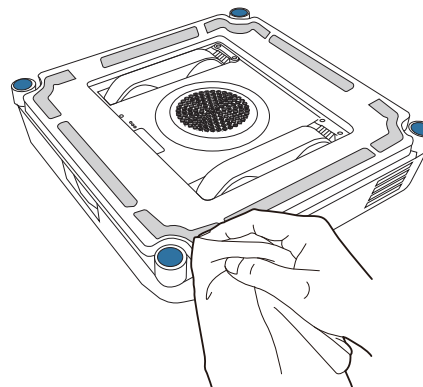

- * Clean in time when the mopping pad is dirty. Make sure that the small particles on the mopping pad are completely removed to avoid scratching the glass.

3 Finish

Pause

During cleaning, press  on WINBOT or pause it via App.

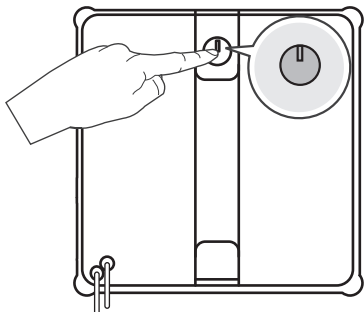

Remove WINBOT

When cleaning is complete, WINBOT will return to the starting position and beep. Please hold the handle tightly. **Long press**  **for 2 seconds**, and remove it after the fan stops working.

* Please pour out the cleaning solution after cleaning.

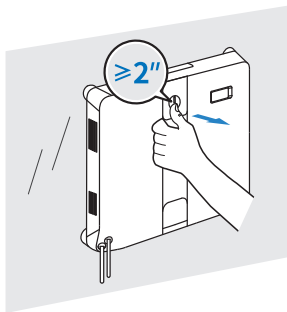

Power Off

Turn off the power to shut down.

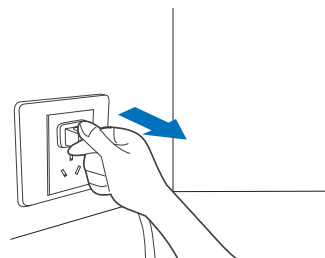

Unfasten Safety Rope



2.4 Advanced Function

To enjoy all available features, it is recommended to control your WINBOT via the ECOVACS HOME App.

a. Multiple Cleaning Modes

Deep Cleaning Mode: Clean for multiple times.

Fast Cleaning Mode: Realize all-round cleaning.

Spot Cleaning Mode: Say goodbye to stubborn stains.

b. Troubleshooting

When the WINBOT alarms, do not panic. You can check the detailed troubleshooting guidance through the App.

c. Remote Control

Through the App, you can remotely control WINBOT. This function supports views of both inside and outside windows, spot cleaning and manual water spraying.

1. Scan the QR Code under the Top Cover to download the App.

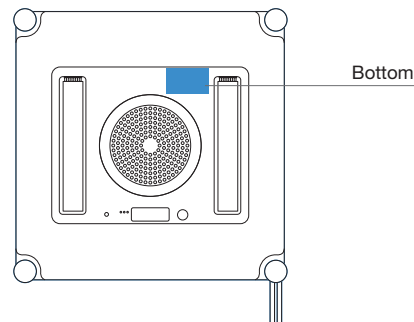

2. Scan the QR code or search and download the ECOVACS HOME App in the app store.



Note: When installation completed, please complete registration, login and network connection according to the guidance in the App.

3.Maintenance

Mopping Pad

a. Replace the Mopping Pad

Remove the dirty mopping pad from WINBOT. Place a new one flat within the mopping pad holder at the bottom of WINBOT. Ensure that the groove of the mopping pad corresponds to the blue mark at the bottom of WINBOT. Then press it with your hands to make the mopping pad stick firmly. Please make sure the mopping pad is correctly attached.

Be careful not to stick the mopping pad outside the holder to avoid affecting the normal operation of WINBOT.

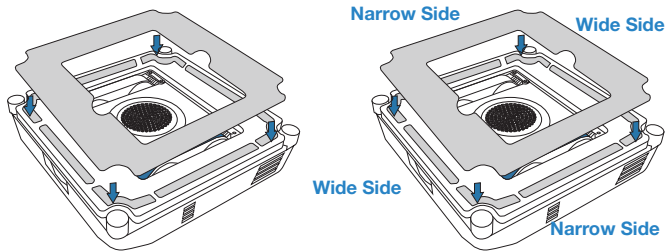

***If the velcro on the mopping pad holder is dusty, it can be cleaned with a clean cleaning brush. Do not wash with water to avoid damage caused by water entering the bottom of the robot.**

b. Wash the Mopping Pad

Remove the mopping pad. Wash it with tap water, and wring it dry before use.

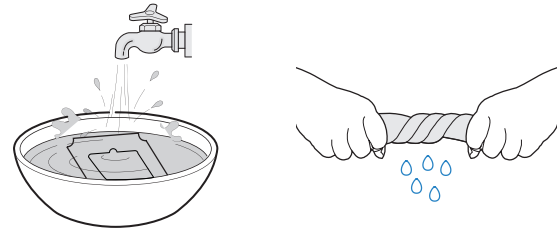

* Washing the Mopping Pad regularly can extend its service life. If the Mopping Pad becomes worn or no longer fits exactly within the fastener area, replace it with a new one to achieve optimal cleaning performance.

* Explore more accessories at ECOVACS HOME App or at <https://www.ecovacs.com/global>.

<https://mall.ecovacs.cn>

Driving Wheel Tracks

Before cleaning, make sure that the fan is not in operation. Inspect the driving wheel tracks in ECOVACS HOME App. Please stop the driving wheel tracks if you see dirt on them. Then wipe them clean with a clean cloth.

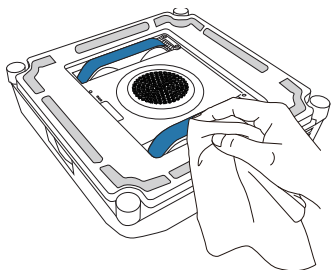

After maintenance, you can install the mopping pad to continue cleaning task.

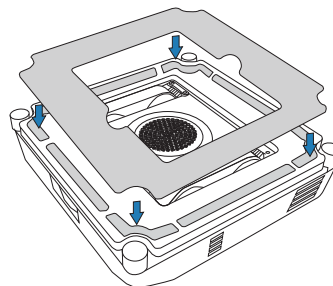

Bottom Component

Fan: Wipe clean with a dry cloth to prevent damage to the suction force of WINBOT.

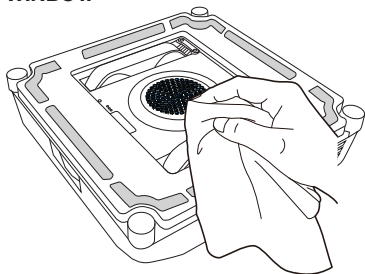

Spherical Sensors: Wipe clean with a dry cloth to maintain its sensitivity.

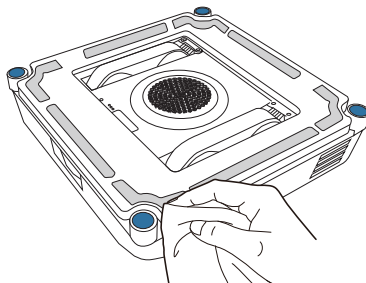

Side Rollers: Wipe clean with a dry cloth to maintain its sensitivity.

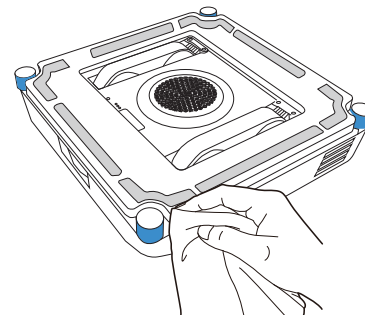

* After WINBOT issues a low battery warning, be sure to fully charge WINBOT before using or storing it to avoid reducing the service life of the battery.

* If WINBOT is not used for a long time, fully charge it, turn it off and then store it. Charge it at least every six months to prevent battery damage due to over-discharge and inability to charge.

4. Status Indicator Light

Indicator	Light Effect	Light Effect Interpretation
WINBOT Status Indicator Light	Solid Blue	WINBOT is in standby or is currently cleaning.
	Flashing Red	WINBOT is unable to function properly.
Adapter Status Indicator Light	Solid Green	Station consumes a low current, for instance, in standby mode.
	Solid Red	Station consumes a high current, for instance, in charging mode.

5. Troubleshooting

5.1 Malfunction Elimination

NO.	Malfunction	Possible Causes	Solutions
1	WINBOT slips, such as sliding sideways or body shaking.	The mopping pad is too wet.	Replace the Mopping Pad as described in Maintenance.
		WINBOT wipes non-recommended stains such as oil stains.	Clean the Driving Wheel Tracks as described in Maintenance.
2	WINBOT voice prompts "Insufficient air pressure".	The Mopping Pad is attached improperly.	Please remove the Mopping Pad and reattach.
		There are gaps or cracks on the window.	Do not use WINBOT on the surface with gaps.
		There are low obstacles on the window surface.	Manually cover the obstacles before using WINBOT.
3	WINBOT voice prompts "Stuck".	The Driving Wheel Tracks are stuck.	Check if there is any dust or debris on the Driving Wheel Tracks. If so, please clean them with tools. Then restart WINBOT for auto cleaning. If problem persists, please contact customer service.
		There are low obstacles on the window surface.	WINBOT cannot detect obstacles or frames with a height lower than 4mm. In this case, please go to the App and follow the instructions to help WINBOT out.

NO.	Malfunction	Possible Causes	Solutions
4	WINBOT does not spray water.	There is no cleaning solution in the water tank.	Please add ECOVACS WINBOT cleaning solution in time.
		The auto spraying function is turned off in the App.	Please go to the App and turn on the auto spraying function.
		WINBOT is cleaning at low water level.	If the auto spraying function is on in the App and there is cleaning solution in the water tank, go to the App and follow the auto spraying precautions to solve the problem. If the problem persists, please contact customer service.
5	WINBOT voice prompts "WINBOT encounters an obstacle".	The internal components are abnormal.	Firmly hold the composite cable and do not stand directly under WINBOT to prevent being injured by the falling WINBOT. Slowly drag the WINBOT until it can be reached. Long press the start button for 2 seconds and then remove WINBOT. Turn off and power off, then restart. If the issue persists after restarting, please contact customer service.
6	WINBOT has not returned to the origin and cannot be removed.	There is an error in the algorithm.	Affected by the calculation accuracy, there may be a slight error. The normal error is less than 21cm. If the error of WINBOT returning to the origin is too large and it is inconvenient to retrieve WINBOT, please go to the App and remote control WINBOT to return to a position that is easy to remove.
		The remote control function was used after WINBOT was adhered, so WINBOT does not know the origin position.	Go to the App and use remote control to help WINBOT return to a position that is easy to remove.
7	WINBOT voice prompts "Please avoid the window corners."	When cleaning frameless glass, the adhering position of WINBOT is too close to the window frame.	Hold the handle of WINBOT, long press WINBOT start button for 2 seconds, and then remove WINBOT. Re-adhere WINBOT. It is recommended that the adhering position be more than 10 cm away from the window corners.

6. Technical Specifications

WINBOT Model	WG841-01	Power Adapter Model	GM95-240375-D
Rated Input	24V === 3.75A	Input:	100-240V~ 50-60Hz 2.5A
Rated Power	90W	Output:	24V === 3.75A
WINBOT dimensions (L x W x H mm)	215*215*55		
Off/Standby Mode Power	Less than 0.50W		
Frequency Bands	2400-2483.5 MHz		

Output power of the wireless module is less than 100 mW.

Note: Technical and design specifications may be changed for continues product improvement.

Ecovacs Home Service Robotics Co., Ltd.

No. 518 Songwei Road, Wusongjiang industry Park, Guoxiang Street,
Wuzhong District, Suzhou, Jiangsu, China.