



Electrolux



electrolux.com/register



EN User Manual | **Steam oven**

EVEP6818BF



INSTALLATION

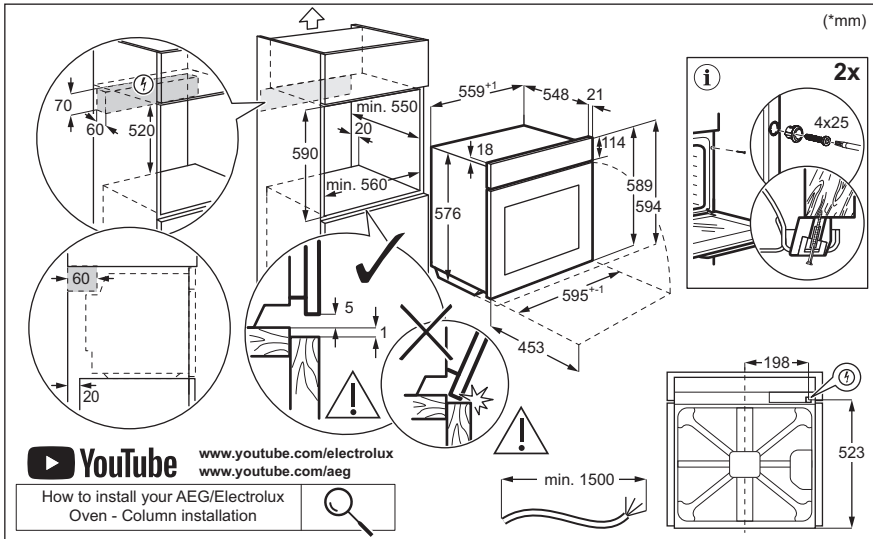
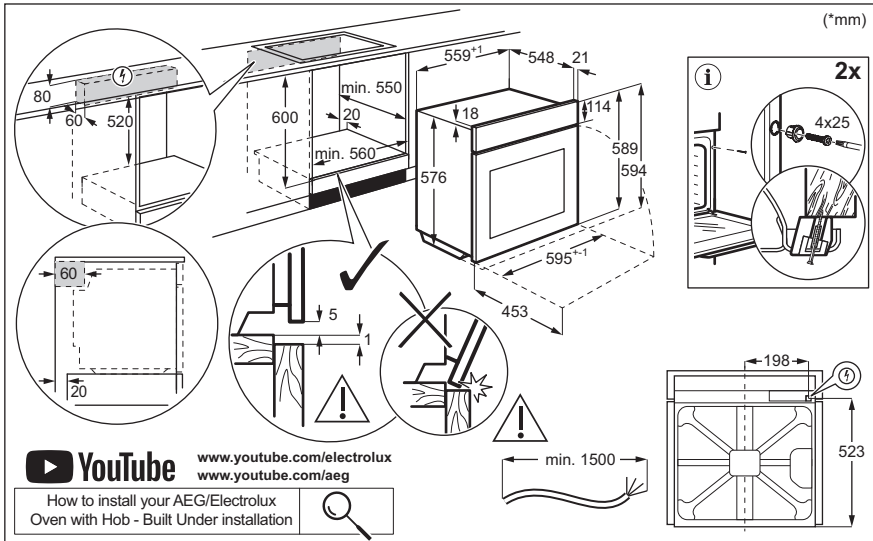

Important Information that may impact your Manufacturer's Warranty

Adherence to the directions for use in this manual is extremely important for health and safety. Failure to strictly adhere to the requirements in this manual may result in personal injury, property damage and affect your ability to make a claim under the Electrolux manufacturer's warranty provided with your product. Products must be used, installed and operated in accordance with this manual. You may not be able to claim on the Electrolux manufacturer's warranty in the event that your product fault is due to failure to adhere to this manual.

WELCOME TO ELECTROLUX! THANK YOU FOR CHOOSING OUR APPLIANCE.



Get usage advice, brochures, troubleshooting, service and repair information at www.electrolux.com



Register your product for better service: www.registerelectrolux.com

Subject to change without notice.

CONTENTS

1. SAFETY INFORMATION.....	3
2. SAFETY INSTRUCTIONS.....	5
3. PRODUCT DESCRIPTION.....	8
4. CONTROL PANEL.....	9
5. BEFORE FIRST USE.....	9
6. DAILY USE.....	10
7. ADDITIONAL FUNCTIONS.....	14
8. CLOCK FUNCTIONS.....	14
9. USING THE ACCESSORIES.....	15
10. HINTS AND TIPS.....	17
11. CARE AND CLEANING.....	19
12. TROUBLESHOOTING.....	22
13. ENERGY EFFICIENCY.....	24
14. WARRANTY - AUSTRALIA AND NEW ZEALAND.....	25
15. ENVIRONMENTAL CONCERNS.....	27

1. ⚠ SAFETY INFORMATION

Before the installation and use of the appliance, carefully read the supplied instructions. The manufacturer is not responsible for any injuries or damage that are the result of incorrect installation or usage. Always keep the instructions in a safe and accessible location for future reference.

1.1 Children and vulnerable people safety

- This appliance can be used by children aged from 8 years and above and persons with reduced physical, sensory or mental capabilities or lack of experience and knowledge if they have been given supervision or instruction concerning the use of the appliance in a safe way and understand the hazards involved. Children of less than 8 years of age and persons with very extensive and complex disabilities shall be kept away from the appliance unless continuously supervised.
- Children should be supervised to ensure that they do not play with the appliance and mobile devices with the app.
- Keep all packaging away from children and dispose of it appropriately.
- **WARNING:** The appliance and its accessible parts become hot during use. Keep children and pets away from the appliance when in use and when cooling down.
- If the appliance has a child safety device, it should be activated.
- Children shall not carry out cleaning and user maintenance of the appliance without supervision.

1.2 General Safety

- This appliance is for cooking purposes only.
- This appliance is designed for single household domestic use in an indoor environment.
- This appliance may be used in offices, hotel guest rooms, bed & breakfast guest rooms, farm guest houses and other similar accommodation where such use does not exceed (average) domestic usage levels.
- Only a qualified person must install this appliance and replace the cable.
- Do not use the appliance before installing it in the built-in structure.
- Disconnect the appliance from the power supply before carrying out any maintenance.

- If the supply cord is damaged, it must be replaced by the manufacturer, its Authorised Service Centre or similarly qualified persons to avoid an electrical hazard.
- The means for disconnection must be incorporated in the fixed wiring in accordance with the wiring rules.
- **WARNING:** Ensure that the appliance is switched off before replacing the lamp to avoid the possibility of electric shock.
- **WARNING:** The appliance and its accessible parts become hot during use. Care should be taken to avoid touching heating elements or the surface of the appliance cavity.
- Always use oven gloves to remove or insert accessories or ovenware.
- Use only the food sensor (core temperature sensor) recommended for this appliance.
- To remove the shelf supports first pull the front of the shelf support and then the rear end away from the side walls. Install the shelf supports in the opposite sequence.
- Do not use a steam cleaner to clean the appliance.
- Do not use harsh abrasive cleaners or sharp metal scrapers to clean the glass door since they can scratch the surface, which may result in shattering of the glass.
- Before pyrolytic cleaning, remove all accessories and excessive deposits/spills from the appliance cavity.

2. SAFETY INSTRUCTIONS

2.1 Installation

WARNING!

Only a qualified person must install this appliance.

- Remove all the packaging.
- Do not install or use a damaged appliance.
- Follow the installation instructions available on our website.
- Always take care when moving the appliance as it is heavy. Always use safety gloves and enclosed footwear.
- Do not pull the appliance by the handle.

- Install the appliance in a safe and suitable place that meets installation requirements.
- Keep the minimum distance from other appliances and units.
- Before mounting the appliance, check if the appliance door opens without restraint.
- The appliance is equipped with an electric cooling system. It must be operated with the electric power supply.

2.2 Electrical connection

WARNING!

Risk of fire and electric shock.

- All electrical connections should be made by a qualified electrician.
- The appliance must be earthed.
- Make sure that the parameters on the rating plate are compatible with the electrical ratings of the mains power supply.
- Always use a correctly installed shockproof socket.
- Do not use multi-plug adapters and extension cables.
- Make sure not to cause damage to the mains plug and to the mains cable. Should the mains cable need to be replaced, this must be carried out by our Authorised Service Centre.
- Do not let mains cables touch or come near the appliance door or the niche below the appliance, especially when it operates or the door is hot.
- The shock protection of live and insulated parts must be fastened in such a way that it cannot be removed without tools.
- Connect the mains plug to the mains socket only at the end of the installation. Make sure that there is access to the mains plug after the installation.
- If the mains socket is loose, do not connect the mains plug.
- Do not pull the mains cable to disconnect the appliance. Always pull the mains plug.
- Use only correct isolation devices: line protecting cut-outs, fuses (screw type fuses removed from the holder), earth leakage trips and contactors.
- The electrical installation must have an isolation device which lets you disconnect the appliance from the mains at all poles. The isolation device must have a contact opening width of minimum 3 mm.
- Fully close the appliance door before you connect the mains plug to the mains socket.
- This appliance is supplied without a main plug and a main cable.

Cable types applicable for installation or replacement for Europe:

H07 RN-F, H05 RN-F, H05 RRF, H05 VV-F, H05 V2V2-F (T90), H05 BB-F, H05Z1Z1-F

For the section of the cable refer to the total power on the rating plate. You can also refer to the table:

Total power (W)	Section of the cable (mm ²)
maximum 1380	3x0.75
maximum 2300	3x1
maximum 3680	3x1.5

The earth cord (green / yellow cable) must be 2 cm longer than the brown phase and blue neutral cables.

2.3 Use

⚠ WARNING!

Risk of injury, burns and electric shock or explosion.

- Do not change the specification of this appliance.
- Make sure that the ventilation openings are not blocked.
- Do not let the appliance stay unattended during operation.
- Deactivate the appliance after each use.
- Be careful when you open the appliance door while the appliance is in operation. Hot air can be released.
- Do not operate the appliance with wet hands or when it comes in contact with water.
- Do not apply pressure on the open door.
- Do not use the appliance as a work surface or as a storage surface.
- Open the appliance door carefully. The use of ingredients with alcohol can cause a mixture of alcohol and air.
- Do not let sparks or open flames to come in contact with the appliance when you open the door.
- Always use glass and jars approved for preserving purposes.
- Do not put flammable products or items moistened with flammable products in, near or on the appliance.
- Do not share your Wi-Fi password.

⚠ WARNING!

Risk of damage to the appliance.

- To prevent damage or discolouration to the enamel:

- do not put ovenware or other objects directly on the bottom of the appliance's cavity.
 - do not put aluminium foil directly on the bottom of cavity of the appliance.
 - do not put water directly into the hot appliance.
 - do not keep moist dishes and food in the appliance after you finish the cooking.
 - be careful when you remove or install the accessories.
- Discolouration of the enamel or stainless steel has no effect on the performance of the appliance.
 - Use a deep pan for moist cakes. Fruit juices cause stains that can be permanent.
 - Use only accessories supplied with this appliance or recommended by the manufacturer.
 - Always cook with the appliance door closed.
 - If the appliance is installed behind a furniture panel (e.g. a door) make sure the door is never closed when the appliance operates. Heat and moisture can build up behind a closed furniture panel and cause subsequent damage to the appliance, the housing unit or the floor. Do not close the furniture panel until the appliance has cooled down completely after use.

2.4 Care and cleaning

WARNING!

Risk of injury, fire, or damage to the appliance.

- Before maintenance, deactivate the appliance and disconnect the mains plug from the mains socket.
- Make sure the appliance is cold. There is the risk that the glass panels can break.
- Replace immediately the door glass panels when they are damaged. Contact the Authorised Service Centre.
- Be careful when you remove the door from the appliance, the door is heavy.
- Clean regularly the appliance to prevent the deterioration of the surface material.
- Clean the appliance with a moist soft cloth. Use only neutral detergents. Do not

use abrasive products, abrasive cleaning pads, solvents or metal objects.

- If you use an oven spray, follow the safety instructions on its packaging.

2.5 Pyrolytic cleaning

WARNING!

Risk of Injury / Fires / Chemical Emissions (Fumes) in Pyrolytic Mode.

- Before carrying out the pyrolytic cleaning and initial preheating remove from the oven cavity:
 - any excess food residues, oil or grease spills / deposits.
 - any removable objects (including shelves, side rails, etc., provided with the appliance) especially any non-stick pots, pans, trays, utensils, etc.
- Read carefully all the instructions for pyrolytic cleaning.
- Keep children away from the appliance while the pyrolytic cleaning operates. The appliance becomes very hot and hot air is released from the front cooling vents.
- Pyrolytic cleaning is a high temperature operation that can release fumes from cooking residues and construction materials, as such consumers are advised to:
 - provide good ventilation during and after the pyrolytic cleaning.
 - provide good ventilation during and after the initial preheating.
- Do not spill or apply water on the oven door during and after the pyrolytic cleaning to avoid damaging the glass panels.
- Fumes released from all pyrolytic ovens / cooking residues as described are not harmful to humans, including children, or persons with medical conditions.
- Keep pets away from the appliance during and after the pyrolytic cleaning and initial preheating. Small pets (especially birds and reptiles) can be highly sensitive to temperature changes and emitted fumes.
- Non-stick surfaces on pots, pans, trays, utensils etc., can be damaged by the high temperature pyrolytic cleaning operation of all pyrolytic ovens and can be also a source for low level harmful fumes.

2.6 Steam Cooking

WARNING!

Risk of burns and damage to the appliance.

- Released Steam can cause burns:
 - Do not open the appliance door during the steam cooking operation.
 - Open the appliance door with care after the steam cooking operation.

2.7 Internal lighting

WARNING!

Risk of electric shock.

- Concerning the lamp(s) inside this product and spare part lamps sold separately: These lamps are intended to withstand extreme physical conditions in household appliances, such as temperature, vibration, humidity, or are intended to signal information about the operational status of the appliance. They are not

intended to be used in other applications and are not suitable for household room illumination.

- This product contains a light source of energy efficiency class G.
- Use only lamps with the same specifications.

2.8 Service

- To repair the appliance contact the Authorised Service Centre.
- Use original spare parts only.

2.9 Disposal

WARNING!

Risk of injury or suffocation.

- Contact your municipal authority for information on how to dispose of the appliance.
- Disconnect the appliance from the mains supply.
- Cut off the mains electrical cable close to the appliance and dispose of it.

3. PRODUCT DESCRIPTION

3.1 General overview

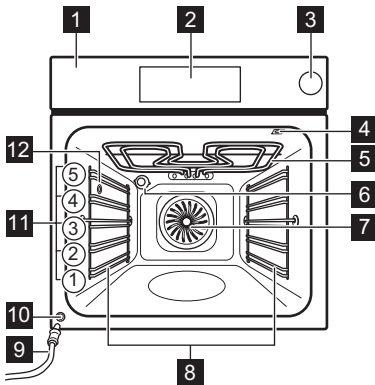

- 1 Control panel
- 2 Display
- 3 Water tank
- 4 Socket for the food sensor
- 5 Heating element
- 6 Lamp
- 7 Fan
- 8 Shelf support, removable
- 9 Draining pipe
- 10 Water outlet valve
- 11 Shelf positions
- 12 Steam outlet

4. CONTROL PANEL

4.1 Control panel overview

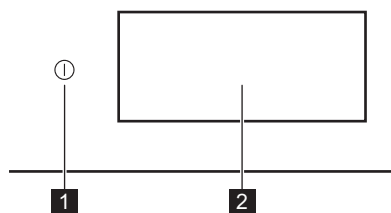

1 ON / OFF Press and hold to turn the appliance on and off.

2 Display Shows the current settings of the appliance.

The control panel provides access to various cooking functions and dishes. It also displays the information about its current operating status.

4.2 Display

The display is fully interactive, scrollable and divided into defined sections. You can swipe across the screen to navigate left or right.

OK To confirm the selection / setting.

> To navigate to the next or previous level in the menu.
<

^ To access and adjust additional settings.
v

♥ To save current settings in: Favourites.

♥ To delete current settings in: Favourites.

☾ To turn the lamp on and off.

☑ To turn the options on and off.

🔒 The appliance is locked.

🔔 Sound Alarm function is activated.

🔔🔕 Sound Alarm and stop cooking function is activated.

🗨️ Pop up message only is activated.

🕒 Delayed start function is activated.

✕ To close the pop-up message or cancel the setting.

📶 Wi-Fi connection is turned on.

📶 Wi-Fi connection is turned off.

📶 Remote Operation is turned on.

📶 Water tank is empty.

📶 Water tank is half full.

📶 Water tank is full.

🕒 Function with energy saving mode.

5. BEFORE FIRST USE

⚠️ WARNING!

Refer to Safety chapters.

5.1 First connection

The display shows welcome message after the first connection. You can choose between starting or skipping the onboarding process.

The settings can be revisited and modified whenever it is necessary.

Adjust the settings: Language, Time of Day, Wireless connection.

5.2 Wireless connection

The appliance enables Wi-Fi network connection and mobile device linking. You

can receive notifications, control and monitor your appliance from your mobile device.

To connect the appliance you need:

- Wireless network with the Internet connection.
 - Mobile device connected to the same wireless network.
1. To download the app scan the QR code located on the back cover of user manual. You can also download the app directly from the app store.
 2. Follow the app onboarding instructions.
 3. Turn on the appliance.
 4. Press  and swipe to the left to enter menu. Select: Settings / Connections.
 5. Press to turn on or off: Wi-Fi.

The appliance wireless module starts within 90 sec.

Frequency	2.4 GHz WLAN : 2400 - 2483.5 MHz
	Bluetooth : 2400 - 2483.5 MHz
Max Power	2.4 GHz WLAN : EIRP < 20 dBm (100 mW)
	Bluetooth : EIRP < 20 dBm (100 mW)
Protocol	2.4 GHz WLAN : IEEE 802.11bgn

5.3 Software licences



The software in this product contains components that are based on free and open source software. Electrolux acknowledges the

contributions of the open software and robotics communities to the development project.

To access the source code of these free and open source software components whose license conditions require publishing, and to see their full copyright information and applicable license terms, visit: <http://electrolux.opensourcerepository.com> (folder NIU6).

5.4 Initial preheating and cleaning

Preheat the empty appliance before the first use and contact with food. The appliance can emit unpleasant smell and smoke. Ventilate the room during preheating.

1. Remove all accessories and removable shelf supports from the appliance.
2. Enter menu and select: Functions.
3. Set the function . Set the maximum temperature. Let the appliance operate for 1 h.
4. Set the function . Set the maximum temperature. Let the appliance operate for 15 min.
5. Turn off the appliance and wait until it is cold.
6. Clean the appliance and the accessories only with a microfibre cloth, warm water and a mild detergent.
7. Put the accessories and removable shelf supports back to their initial position.

6. DAILY USE

WARNING!

Refer to Safety chapters.

6.1 Menu

Press  and swipe to the left to enter menu.

- Dishes
- Functions
- Favourites
- Maintenance
- Settings

6.2 Functions

Submenu includes a list of cooking functions.

The list of functions may vary depending on the software version.

1. Enter menu and select: Functions.
2. Select the heating function.
3. Adjust the settings.
4. Press **START**. You can plug the Food Sensor at any time before or during cooking. Refer to "Using the accessories, Food sensor" chapter.

5.  - press to adjust the settings during cooking.
6. STOP - press to turn off the heating function.



Fast Preheat is available only for some heating functions. For more information on preheat options refer to "Daily use" chapter, Settings, Submenu: Preferences.



Top
Intense heat for rapid browning on top.



Bottom
Evenly brown bottom of food. Good for pizza or pie, and finishing cakes or quiches. Pre-heat the oven and use lowest shelf level.



Hot Air
For everyday cooking on multiple levels. Get evenly cooked dishes without mixing flavours. Set a lower temperature than for Top & Bottom.



Top & Bottom
For everyday cooking on a single level. Good for all foods, like casseroles and baked goods.



Hot air & Top
Roast larger meat joints and poultry with bones for tender results and crispy surface.



Hot air, Top & Bottom
This function is ideal for ready meals.



Hot air, Bottom & Steam
Best for baking pizza and other dishes that require more heat from below.



Steam Low
The function is suitable for meat, oven dishes and casseroles. The combination of steam and heat creates a delicate texture and a crispy surface.



Heat Save Fan
Save energy by using residual heat to cook. Best for pastries.



Reheat
This function gently reheats leftovers with steam.



Grill
Evenly grill or brown vegetables or meat. Also good for toasting bread.



Dough Prove
Optimized temperature for fast rising.



Refresh
Bring back a fresh smell and soft inside to day-old bread or baked goods.



Defrost
Gentle defrosting for further preparation.



Stew
Get tender, juicy stews by simmering the ingredients all together.



Roast
Get a crispy outside and tender inside for meat, poultry, or vegetables.



Bread Baking
Use this function to prepare bread and bread rolls with professional-like result in terms of crispiness, colour and crust gloss.



Slow cook
Slow cooking increases the cooking time, but you will get a better cooking result. Before you put the meat in the oven, sear it.



Preserve
Get juicy fruits and vegetables canned at a low temperature. Put the heat resistant canning jars on a baking tray filled with water.



Plate warming
To preheat plates before serving.



Keep Warm
Keep dishes warm to be served. Please note that some dishes may continue to cook and dry out while being kept warm. Cover the dishes if necessary.



Dehydrate
Evenly dry out fruits, herbs, and vegetables at a low temperature. Open the door occasionally during drying to improve the drying result.



The lamp may turn off automatically at a temperature below 80 °C during some heating functions.

6.3 Dishes

Dishes submenu consists of a set of programmes that are designed for dedicated dishes. Each dish in this submenu is provided with a suitable setting. The time and temperature can be adjusted during cooking.

For some of the dishes you can also cook with Food Sensor.

1. Enter menu and select: Dishes.
 2. Choose a dish or a food type.
 3. Adjust settings according to cooking preferences. Adjust the weight. Option is available for selected dishes. Press **OK**.
 4. Place the food inside the appliance according to the instructions available on the screen.
 5. Press **START**.
- When the function ends, check if the food is ready. Extend the cooking time, if needed.

6.4 Favourites



This functionality is available for selected models only.

You can save up to 20 of your favourite settings, such as heating function and dish. To save the setting select the preferred setting and press .

Select: Favourites

1. Enter menu and press: Favourites to check the saved settings.
2. Select one of the saved settings.

Delete: Favourites

1. Enter menu and press: Favourites to check the saved settings.
2. Press: to delete the saved settings.

6.5 Maintenance

Submenu includes a list of cleaning programmes.

Pyrolytic cleaning	This programme burns off residual dirt in the appliance. You can choose from different cleaning levels. Refer to "Care and Cleaning" chapter.
--------------------	---

6.6 Settings

This submenu includes a list of settings.

Submenu: Setup

Language	To set the appliance language.
----------	--------------------------------

Time of Day	To set the current time.
Display Brightness	To set the display brightness.
Key Tones	To turn the tone of the touch fields on and off. It is not possible to mute the tones for .
Buzzer Volume	To set the volume of key tones and signals.
Temperature unit	To show the current temperature unit.

Submenu: Service

Demo Mode	Activation / deactivation code: 2468
Software Version	Information about software version.
Reset All Settings	Restores factory settings.

Submenu: Preferences

Light	Turns the lamp on and off.
Child Lock	Prevents accidental activation of the appliance.
Preheat/HeatUp	None - conventional way of preheating the appliance. It is set as default and available for all cooking functions. The preference can be changed to another preheat type.
	Eco - preheating the appliance with less energy consumption. It is available for all cooking functions.
	Fast - shortens the heat up time. It is available for some of the functions only.



Cleaning Reminder	Reminds you when to clean the appliance.
Standby Screen Personalisation	To customize the screen features and shortcuts.

Submenu: Connections

Connect To Wi-Fi	To connect the appliance with the wireless network.
------------------	---

Wi-Fi	To enable and disable: Wi-Fi.
Network	To check network status and the signal power of: Wi-Fi.
Forget Network	To disable current network from auto connection with the appliance.
Remote Operation	To start remote operation automatically after pressing START. Option visible only after you turn on: Wi-Fi.

6.7 Steam heating functions

The functions:  Steam Low,  Hot air, Bottom & Steam allow you to use heat and steam to keep meals crispy and juicy.

1. Enter the menu and select: Functions.
2. Set the steam heating function. The display shows available settings.
3. Set the temperature and the steam level, if available.
4. Press **START** and follow the instruction on the display.
5. Press the cover of the water tank to open it.
6. Fill the water tank with cold water to the maximum level (around 950 ml) until the signal sounds or the display shows the message.
Do not fill the water tank over its maximum capacity. There is a risk of water leakage, overflow and furniture damage.

WARNING!

Use only cold tap water. Do not use demineralised or distilled water. Do not pour flammable or alcoholic liquids into the water tank.

7. Fill the water tank with cold water to the maximum level (around 900 ml) until the signal sounds or the display shows the message.
Do not fill the water tank over its maximum capacity. There is a risk of water leakage, overflow and furniture damage.

WARNING!

Use only cold tap water. Do not use demineralised or distilled water. Do not pour flammable or alcoholic liquids into the water tank.

8. Push the water tank to its initial position. When the appliance reaches the set temperature, the signal sounds.
9. When the water tank runs out of water, the signal sounds. Refill the water tank.
10. Turn off the appliance.
11. Empty the water tank.
12. After cooking, carefully open the oven door. Residual water can condensate in the oven interior. Wait for at least 60 min after each use to prevent hot water from exiting the water outlet valve.

WARNING!

The appliance is hot. There is a risk of burns. Be careful while emptying the water tank.

6.8 Emptying water tank

Empty the water tank after each steam cooking to prevent limestone residue.

1. Turn off the appliance. Leave the oven door open and wait until the appliance is cold.
2. Connect the draining pipe **C** to the outlet valve **A** through the connector **B**.

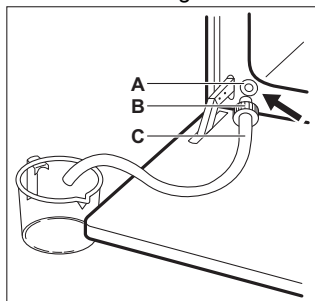

3. Keep the end of the pipe below the level of **A** and push **B** repeatedly to collect remaining water.
4. Detach **C** and **B** and dry the oven interior with a soft sponge.



Do not use the drained water to fill the water tank again.

6.9 Notes on: Heat Save Fan

This function was used to comply with the energy efficiency class and ecodesign requirements (according to EU 65/2014 and EU 66/2014). Tests according to: IEC/EN 60350-1.

The oven door should be closed during cooking so that the function is not interrupted and the oven operates with the highest energy efficiency possible.

When you use this function the lamp automatically turns off after 30 sec.

For the cooking instructions refer to Hints and tips, Heat Save Fan. For general energy saving recommendations refer to Energy efficiency, Energy saving tips.

7. ADDITIONAL FUNCTIONS

7.1 Child Lock

This function prevents accidental operation of the appliance. It can be activated at any time.

1. Enter menu.
2. Select: Settings / Preferences / Child Lock.

Child Lock is activated. To enable the use of the appliance, press the code letters in an alphabetical order.

7.2 Automatic switch-off

For safety reasons, if the heating function is active and no settings are changed, the appliance will turn off automatically after a certain period of time.

(°C)	(h)
30 - 115	12.5

(°C)	(h)
120 - 195	8.5
200 - 245	5.5
250 - maximum	3

If you intend to run a heating function for a duration exceeding the automatic switch-off time, set the cooking time. Refer to Clock functions.



7.3 Cooling fan

When the appliance operates, the cooling fan turns on automatically to keep the surfaces of the appliance cool. If you turn off the appliance, the cooling fan can continue to operate until the appliance cools down.

8. CLOCK FUNCTIONS

8.1 Clock functions description

Function	Description
Timer	To set the cooking duration. Maximum is 23 h 59 min. To set what happens when the time is up select preferred: End Action. Timer can be used independently, even when the oven is not running.

Function	Description
End Action	<p> Sound Alarm When the time is up the signal sounds. This function can be set at any time, even when the appliance is turned off.</p> <hr/> <p> Sound Alarm and stop cooking When the time is up the signal sounds and the heating function turns off.</p> <hr/> <p> Pop up message only When the time is up the message appears on the display. This function has no effect on the operation of the appliance.</p>
Delayed start	To postpone the start and / or end of cooking.
Time Extension	To extend the cooking time.
Uptimer	To show how long the appliance operates. Maximum is 23 h 59 min. It starts automatically when an oven process is started and stops when the process is finished. It is visible on the main screen in case where no other timer is set. This function has no effect on the operation of the appliance.

8.2 Timer

1. Choose the heating function and set the temperature.
2. Press: Timer.

3. Set the duration. You can select the preferred end action by pressing one of the symbols.
4. Press **OK** to confirm and return to the main screen.

8.3 Delayed start

1. Choose the heating function and adjust the settings.
2. Press *******.
3. Press: Delayed start.
4. Scroll to set desired start time and press **OK**.
5. You can now set desired End time or press **OK** to skip this step.
6. Press **OK** to return to the main screen.

8.4 Time of Day

1. Turn on the appliance.
2. Press: Settings / Setup / Time of Day.
3. Set the time.
4. Press **OK**.

8.5 Changing timer settings

You can change the set time during cooking at any time.

1. Press **^** / Timer.
2. Set new timer value. Press **OK**.

9. USING THE ACCESSORIES

WARNING!

Refer to Safety chapters.

9.1 Inserting accessories

Accessories available depending on model. Scan the QR code to check how to use accessories supplied with your appliance. You can order optional accessories separately. For more information, please contact your local supplier.



A small indentation at the top increases safety and provides tilt protection. The indentations are also anti-tip devices. The rim around the shelf prevents cookware from slipping off the shelf.

Insert the accessory (wire shelf / tray) between the guide bars of the shelf support. Make sure that the shelf touches the back of the oven interior and the feet point down.

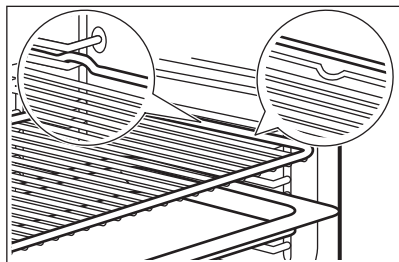

If your tray has a slope, position it towards the back of the oven interior.

If there is an inscription on the accessory, make sure it is facing you.

If you are using a tray with holes place the tray / pan underneath, to collect dripping liquids.

9.2 Food Sensor

It measures the temperature inside the food.

There are two temperatures to be set:

- °C - the temperature inside the appliance. It should be at least 25°C higher than the food core temperature.
- \mathcal{R} - the food core temperature.

Recommendations:

- Ingredients should be at room temperature.
- Do not use it for liquid dishes.
- During cooking the needle of the food sensor must be fully inserted in the dish.

Cooking with: Food Sensor

WARNING!

There is a risk of burns as Food Sensor and shelf supports become hot. Do not touch Food Sensor handle with bare hands. Always use oven gloves.

1. Select a heating function from the menu: Functions or a dish from the menu: Dishes.
2. Set the oven temperature and cooking time, if needed.
3. Press OK.
4. Press START .
5. Insert Food Sensor inside the dish:

Meat, poultry and fish

Insert the entire needle of the Food Sensor into the meat or fish at its thickest part.

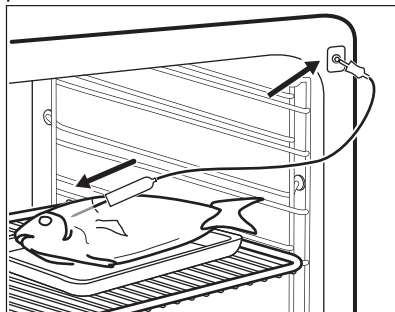

Casserole

Insert the tip of Food Sensor exactly in the centre of the casserole. Food Sensor should be stabilized in one place during cooking. Use a solid ingredient to achieve that. Use the rim of the baking dish to support the silicone handle of Food Sensor. The tip of Food Sensor should not touch the bottom of a baking dish.

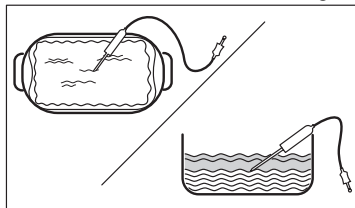

6. Plug Food Sensor into the socket located inside the appliance. Refer to Product description.

The display shows the symbol and the current temperature of Food Sensor.

7. ^ - press to adjust the settings.
8. Select Food Sensor card to set the core temperature of the sensor or set up the preferred option:
 - Sound Alarm - when food reaches the core temperature, the signal sounds.
 - Sound Alarm and stop cooking - when food reaches the core temperature, the signal sounds and the cooking stops.
 - Pop up message only - when food reaches the core temperature, the message appears on the display.
9. Press OK.

10. When the food reaches the set temperature, the signal sounds. Check if the food is ready. Extend the cooking time, if needed.
11. STOP - press to turn off the heating function.
12. Remove Food Sensor plug from the socket and remove the dish from the appliance.

9.3 Steam pot for steam cooking



Steam pot is supplied with the appliance for selected models only.

Steam pot consists of:

- A. Injector tube - for steam cooking,
- B. Lid,
- C. Steel grill,
- D. Glass bowl.

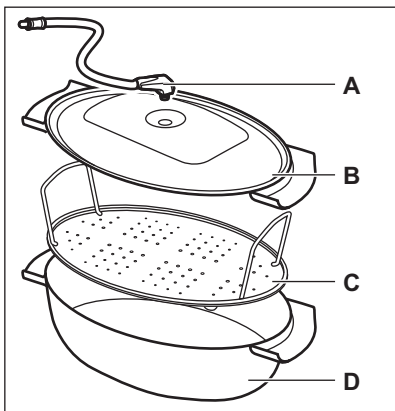

Do not:

- put the hot steam pot on cold / wet surfaces.
- pour cold liquids into the steam pot when it is hot.
- use the steam pot on a hot cooking surface.
- clean the steam pot with abrasives, scourers and powders.

9.4 Steam cooking in the steam pot

1. Put the food onto the steel grill in the steam pot and cover it with the lid.
2. Put the injector tube into the hole in the lid.
3. Put the steam pot onto the second shelf position from the bottom.
4. Connect the injector tube to the steam inlet. Refer to Product description.
5. Set the appliance for the steam cooking function.

10. HINTS AND TIPS

10.1 Cooking recommendations

The temperature and cooking times in the tables are for guidance only. They depend on the recipes, quality and quantity of the ingredients used.







Your appliance may bake or roast differently than your previous appliance. The hints below show recommended settings for temperature, cooking time and shelf position for specific types of food.

Count the shelf positions from the bottom of the oven floor.

If you cannot find the settings for a specific recipe, look for a similar one.

For energy saving tips refer to Energy efficiency.

Symbols used in the tables:

	Food type
	Heating function
	Temperature
	Accessory
	Shelf position
	Cooking time (min)





10.2 Heat Save Fan - recommended accessories





Use dark and non-reflective tins and containers. They have better heat absorption than light colour and reflective dishes.

- **Pizza pan** - dark, non-reflective, diameter 28 cm
- **Baking dish** - dark, non-reflective, diameter 26 cm
- **Ramekins** - ceramic, diameter 8 cm, height 5 cm
- **Flan base tin** - dark, non-reflective, diameter 28 cm

10.3 Heat Save Fan





For the best results follow suggestions listed in the table below.

		°C		
Sweet rolls, 16 pieces	baking tray or dripping pan	180	2	20 - 30
Rolls, 9 pieces	baking tray or dripping pan	180	2	30 - 40
Pizza, frozen, 0.35 kg	wire shelf	220	2	10 - 15
Swiss Roll	baking tray or dripping pan	170	2	25 - 35
Brownie	baking tray or dripping pan	175	3	25 - 30
Soufflè, 6 pieces	ceramic ramekins on wire shelf	200	3	25 - 30
Sponge flan base	flan base tin on wire shelf	180	2	15 - 25
Victoria sandwich	baking dish on wire shelf	170	2	40 - 50
Poached fish, 0.3 kg	baking tray or dripping pan	180	3	20 - 25
Whole fish, 0.2 kg	baking tray or dripping pan	180	3	25 - 35
Fish fillet, 0.3 kg	pizza pan on wire shelf	180	3	25 - 30
Poached meat, 0.25 kg	baking tray or dripping pan	200	3	35 - 45
Shashlik, 0.5 kg	baking tray or dripping pan	200	3	25 - 30
Cookies, 16 pieces	baking tray or dripping pan	180	2	20 - 30
Macaroons, 24 pieces	baking tray or dripping pan	180	2	25 - 35
Muffins, 12 pieces	baking tray or dripping pan	170	2	30 - 40
Savory pastry, 20 pieces	baking tray or dripping pan	180	2	25 - 30

		°C		
Short crust biscuits, 20 pieces	baking tray or dripping pan	150	2	25 - 35
Tartlets, 8 pieces	baking tray or dripping pan	170	2	20 - 30
Vegetables, poached, 0.4 kg	baking tray or dripping pan	180	3	35 - 45
Vegetarian omelette	pizza pan on wire shelf	200	3	25 - 30
Mediterranean vegetables, 0.7 kg	baking tray or dripping pan	180	4	25 - 30

10.4 Information for test institutes

Tests according to IEC 60350-1.

				°C	
Small cakes, 20 per tray	Top & Bottom	Baking tray	3	170	20 - 35
Small cakes, 20 per tray	Hot Air	Baking tray	3	150 - 160	20 - 35
Small cakes, 20 per tray	Hot Air	Baking tray	2 and 4	150 - 160	20 - 35
Apple pie, 2 tins Ø20 cm	Top & Bottom	Wire shelf	2	180	70 - 90
Apple pie, 2 tins Ø20 cm	Hot Air	Wire shelf	2	160	70 - 90
Fatless sponge cake, cake mould Ø26 cm ¹⁾	Top & Bottom	Wire shelf	2	170	40 - 50
Fatless sponge cake, cake mould Ø26 cm ¹⁾	Hot Air	Wire shelf	2	160	40 - 50
Fatless sponge cake, cake mould Ø26 cm ¹⁾	Hot Air	Wire shelf	2 and 4	160	40 - 60
Short bread	Hot Air	Baking tray	3	140 - 150	20 - 40
Short bread	Hot Air	Baking tray	2 and 4	140 - 150	25 - 45
Short bread	Top & Bottom	Baking tray	3	140 - 150	25 - 45
Toast ¹⁾	Grill	Wire shelf	4	max.	1 - 5

1) Preheat the appliance for 10 minutes.

11. CARE AND CLEANING

WARNING!

Refer to Safety chapters.

11.1 Notes on cleaning

Cleaning agents

- Clean the front of the appliance only with a microfibre cloth with warm water and a mild detergent.
- Use a cleaning solution to clean metal surfaces.
- Clean stains with a mild detergent.

Everyday use

- Clean the interior of the appliance after each use. Fat accumulation or other residue may cause fire.
- Moisture can condense in the appliance or on the door glass panels. To decrease the condensation, let the appliance work for 10 minutes before cooking. Do not store food in the appliance for longer than 20 minutes. Dry the interior of the appliance only with a microfibre cloth after each use.

Accessories

- Clean all accessories after each use and let them dry. Use only a microfibre cloth with warm water and a mild detergent. Do not clean the accessories in a dishwasher.
- Do not clean the non-stick accessories using abrasive cleaner or sharp-edged objects.

11.2 Removing the shelf supports

Remove the shelf supports to clean the appliance.

1. Turn off the appliance and wait until it is cold.
2. Pull the front of the shelf support away from the side wall.
3. Pull the rear end of the shelf support away from the side wall and remove it.

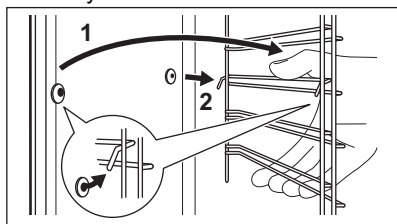

4. Put the shelf supports back to the initial position. Repeat the steps in the reverse order.

If the telescopic runners are supplied, its retaining pins must point to the front.

11.3 Pyrolytic cleaning

This programme burns off residual dirt in the appliance. When the cleaning cycle ends and the appliance cools down, wipe away the ash. Use it whenever your appliance needs a deep cleaning.

⚠ WARNING!

There is a risk of burns.

⚠ CAUTION!

If a hob is installed above the oven or if there are other appliances installed in the same cabinet, do not use them at the same time as this function. It can cause damage to the oven.

Do not start the function if you did not fully close the oven door.

1. Make sure the appliance is cold.
2. Remove all accessories.
3. Clean the oven floor and the inner door glass to remove any remaining food particles. Use warm water, a soft cloth and a mild detergent.
4. Press: Maintenance / Pyrolytic cleaning.
5. Select the cleaning mode and press **START**. Follow the instruction on the display.

Option	Duration
Pyrolytic cleaning, quick	1 h
Pyrolytic cleaning, normal	1 h 30 min
Pyrolytic cleaning, intense	2 h 30 min

When the cleaning starts, the oven door is locked. The cooling fan works at a higher speed.

6. The signal sounds when the cleaning ends.
7. When the appliance is cold, clean the oven floor with a wet soft cloth.



When this function works, the lamp is off.

11.4 Cleaning the water tank

1. Turn off the appliance.
2. Pour water into the water tank: 650 ml. Add lactic acid: 250 ml. Wait for 60 min.
3. Empty the water tank. Refer to Daily use, Emptying water tank.
4. Rinse the water tank and clean the remaining limestone residue with a soft cloth.

5. Clean the drain pipe with warm water and a mild detergent.

Contact your water supplier to check the water hardness level.

Water classification:	Clean the water tank every:
soft	120 h - 16 months
moderately hard	90 h - 12 months
hard	60 h - 8 months
very hard	30 h - 4 months

11.5 Cleaning Reminder

When the reminder appears, cleaning is recommended.

Use the function: Pyrolytic cleaning.

11.6 Removing and installing door

You can remove the oven door and the internal glass panels to clean them. Read the whole "Removing and installing door" instruction before you remove the glass panels.

CAUTION!

Do not use the appliance without the glass panels.

1. Open the door fully and hold both hinges.

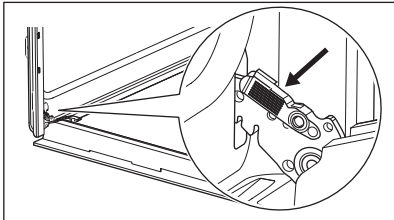

2. Lift and pull the latches until they click.

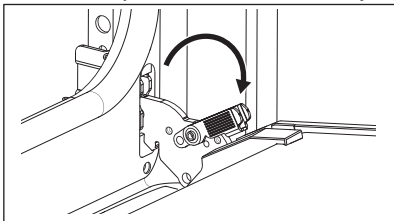

3. Close the oven door halfway to the first opening position. Then lift and pull to remove the door from its seat.

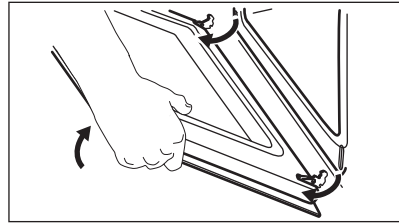

4. Put the door on a soft cloth on a stable surface.
5. Hold the door trim **A** on the top edge of the door at the two sides and push inwards to release the clip seal.

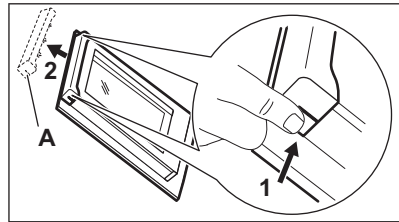

6. Pull the door trim to the front to remove it.
7. Hold the door glass panels on their top edge one by one and pull them up out of the guide. Make sure the glass slides out of the supports completely.

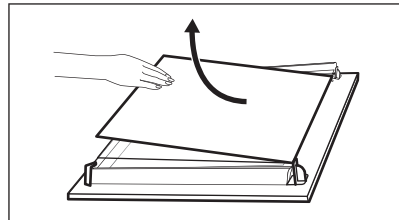

8. Clean the glass panels with water and soap. Dry the glass panels carefully. Do not clean the glass panels in the dishwasher.
9. After cleaning, install the glass panels and the oven door. Make sure that you put the glass panels back in the correct sequence. Check for the symbol / printing on the side of the glass panel. If the door is installed correctly, you will hear a click when closing the latches.



The printing zone **B** (if present) must face the oven interior.

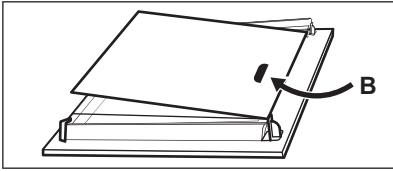

11.7 Replacing the lamp



WARNING!

Risk of electric shock.
The lamp can be hot.

1. Turn off the appliance and wait until it is cold.
2. Disconnect the appliance from the mains.
3. Place the cloth on the oven floor.



CAUTION!

Always hold the halogen lamp with a cloth to prevent grease residue from burning on the lamp.

Back lamp

1. Turn the glass cover to remove it.
2. Clean the glass cover.
3. Replace the lamp with a suitable 300°C heat-resistant lamp.
4. Install the glass cover.

12. TROUBLESHOOTING



WARNING!

Refer to Safety chapters.

12.1 What to do if...

Problem description	Cause and remedy
You cannot activate or operate the appliance.	The appliance is not connected to an electrical supply or it is connected incorrectly.
The appliance does not heat up.	The clock is not set. To set the clock refer to Clock functions.
	The door is not closed correctly.
	The fuse is blown. Make sure the fuse is the cause of the problem. If the problem recurs, contact a qualified electrician.
	Child Lock is activated.
The lamp is turned off.	The lamp is burnt out. Replace the lamp. For details refer to Care and cleaning.
There is water in the appliance cavity.	The water tank was filled with too much water.
The steam cooking does not work.	There is lime residue in the steam inlet opening.
	There is no water in the water tank.
It takes more than 3 min to empty the water tank or the water leaks from the steam inlet opening.	There is lime residue in the steam inlet opening. Clean the water tank.

Problem description	Cause and remedy
 Power cut always stops cleaning. Repeat cleaning if it's interrupted by power failure.	
Trouble with wireless network signal.	Check if your mobile device is connected to the wireless network. Check your wireless network and router. Restart the router.
New router installed or router configuration changed.	To configure appliance and mobile device again, refer to Before first use, Wireless connection.
The wireless network signal is weak.	Move router as close to the appliance as possible.
The wireless signal is disrupted by microwave oven placed near the appliance.	Turn off the microwave oven. Avoid using microwave oven and the Remote operation of the appliance at the same time. Microwaves disrupt WiFi signal.

12.2 Error codes

When the software error occurs, the display shows error message. You will find the list of problems in the table below.

Code and description	Remedy
F102 - the door is not fully closed or the door lock is broken. 1)	Close the door. Turn the appliance off and on.
F111 - Food Sensor is not correctly inserted into the socket.	Fully plug Food Sensor into the socket.
F240, F239 - the touch fields on the display do not work properly.	Clean the surface of the display. Make sure there is no dirt on the touch fields.
F908 - the appliance system cannot connect with the control panel.	Turn the appliance off and on.
F602, F603 - Wi-Fi is not available. 1) 2)	Turn the appliance off and on.

1) When the following error message continues to appear on the display, it means a faulty subsystem may have been disabled. In such a case contact your dealer or an Authorized Service Centre.

2) If one of these errors occurs, the rest of the appliance functions will continue to work as usual.

12.3 Service data

If you cannot find a solution to the problem yourself, contact your dealer or an Authorised Service Centre.

The necessary data for the service centre is on the rating plate. The rating plate is located on the front frame of the appliance. It is visible when you open the door. Do not remove the rating plate from the appliance.

We recommend that you write the data here:

Model (MOD.):

Product number (PNC):

Serial number (S.N.):

13. ENERGY EFFICIENCY

13.1 Product Information Sheet and Product Information according to EU Energy Labelling and Ecodesign Regulations

Supplier's name	Electrolux
Model identification	EVEP6818BF 949284714
Energy Efficiency Index	61.2
Energy efficiency class	A++
Energy consumption with a standard load, conventional mode	0.93 kWh/cycle
Energy consumption with a standard load, fan-forced mode	0.52 kWh/cycle
Number of cavities	1
Heat source	Electricity
Volume	72 l
Type of oven	Built-In Oven
Mass	36.0 kg

IEC/EN 60350-1 - Household electric cooking appliances - Part 1: Ranges, ovens, steam ovens and grills - Methods for measuring performance.

13.2 Product information for power consumption and maximum time to reach applicable low power mode

Power consumption in standby	0.8 W
Power consumption in network standby	2.0 W
Maximum time needed for the equipment to automatically reach the applicable low power mode	20 min

For guidance on how to activate and deactivate the wireless network connection, refer to Before first use.

13.3 Energy saving tips

Following tips below will help you save energy when using your appliance.

Make sure that the appliance door is closed when the appliance operates. Do not open the appliance door too often during cooking. Keep the door gasket clean and make sure it is well fixed in its position.

Use metal cookware and dark, non-reflective tins and containers to improve energy saving.

Do not preheat the appliance before cooking unless specifically recommended.

Keep breaks between baking as short as possible when you prepare a few dishes at one time.

Cooking with fan

When possible, use the cooking functions with fan to save energy.

Residual heat

When the cooking duration is longer than 30 min, reduce the appliance temperature to minimum 3 - 10 min before the end of cooking. The residual heat inside the appliance will continue to cook.

Use the residual heat to keep the food warm or warm up other dishes.

When you turn off the appliance, the display shows the residual heat or temperature.

If a programme with Timer is activated and the cooking time is longer than 30 min, the heating elements automatically turn off earlier in some appliance functions.

Keep food warm

Choose the lowest possible temperature setting to use residual heat and keep the food warm. The residual heat indicator or temperature appears on the display.

Cooking with the lamp off

Turn off the lamp during cooking. Turn it on only when you need it.

Heat Save Fan

Function designed to save energy during cooking.

When you use this function the lamp automatically turns off after 30 sec. You may turn on the lamp again but this action will reduce the expected energy savings.

14. WARRANTY - AUSTRALIA AND NEW ZEALAND

FOR SALES IN AUSTRALIA AND NEW ZEALAND

APPLIANCE: ELECTROLUX BUILT-IN OVENS, COOKTOPS, FREESTANDING COOKER AND WARMING DRAWER

This document sets out the terms and conditions of the product warranties for Electrolux Appliances. It is an important document. Please keep it with your proof of purchase documents in a safe place for future reference should there be a manufacturing defect in your Appliance. This warranty is in addition to other rights you may have under the Australian Consumer Law.

1. In this warranty:

- a) 'ACL' or 'Australian Consumer Law' means Schedule 2 to the Competition and Consumer Act 2010;
- b) 'Appliance' means any Electrolux product purchased by you and accompanied by this document;
- c) 'ASC' means Electrolux's authorised serviced centres;
- d) 'Electrolux' is the brand controlled by Electrolux Home Products Pty Ltd of 163 O'Riordan Street, Mascot NSW 2020, ABN 51 004 762 341 in respect of Appliances purchased in Australia and Electrolux (NZ) Limited (collectively "Electrolux") of 3-5 Niall Burgess Road, Mount Wellington, in respect of Appliances purchased in New Zealand;

- e) 'Warranty Period' means the period specified in clause 3 of this warranty;
- f) 'you' means the purchaser of the Appliance not having purchased the Appliance for re-sale, and 'your' has a corresponding meaning.

2. **Application:** This warranty only applies to new Appliances, purchased and used in Australia or New Zealand and is in addition to (and does not exclude, restrict, or modify in any way) other rights and remedies under a law to which the Appliances or services relate, including any nonexcludable statutory guarantees in Australia and New Zealand.
3. **Warranty Period:** Subject to these terms and conditions, this warranty continues for in Australia for a period of 36 months and in New Zealand for a period of 36 months, following the date of original purchase of the Appliance.
4. **Repair or replace warranty:** During the Warranty Period, Electrolux or its ASC will, at no extra charge if your Appliance is readily accessible for service, without special equipment and subject to these terms and conditions, repair or replace any parts which it considers to be defective. Electrolux may, in its absolute discretion, choose whether the remedy offered for a valid warranty claim is repair or replacement. Electrolux or its ASC may use refurbished parts to repair your Appliance. You agree that any replaced Appliances or parts become the property of Electrolux.

5. Travel and transportation costs:

Subject to clause 7, Electrolux will bear the reasonable cost of transportation, travel and delivery of the Appliance to and from Electrolux or its ASC. Travel and transportation will be arranged by Electrolux as part of any valid warranty claim.

6. Proof of purchase is required before you can make a claim under this warranty.

7. Exclusions: You may not make a claim under this warranty unless the defect claimed is due to faulty or defective parts or workmanship. This warranty does not cover:

- a) light globes, batteries, filters or similar perishable parts;
- b) parts and Appliances not supplied by Electrolux;
- c) cosmetic damage which does not affect the operation of the Appliance;
- d) damage to the Appliance caused by:
 - negligence or accident;
 - misuse or abuse, including failure to properly maintain or service;
 - improper, negligent or faulty servicing or repair works done by anyone other than an Electrolux authorised repairer or ASC;
 - normal wear and tear;
 - power surges, electrical storm damage or incorrect power supply;
 - incomplete or improper installation;
 - incorrect, improper or inappropriate operation;
 - insect or vermin infestation;
 - failure to comply with any additional instructions supplied with the Appliance;

In addition, Electrolux is not liable under this warranty if:

- a. the Appliance has been, or Electrolux reasonably believes that the Appliance has been, used for purposes other than those for which the Appliance was intended, including where the Appliance has been used for any non-domestic purpose;

- b. the Appliance is modified without authority from Electrolux in writing;
- c. the Appliance's serial number or warranty seal has been removed or defaced

8. How to claim under this warranty: To enquire about claiming under this warranty, please follow these steps:

- a. carefully check the operating instructions, user manual and the terms of this warranty;
- b. have the model and serial number of the Appliance available;
- c. have the proof of purchase (e.g. an invoice) available;
- d. telephone the numbers shown below.

9. Australia: For Appliances and services provided by Electrolux in Australia: Electrolux goods come with guarantees that cannot be excluded under the Australian Consumer Law. You are entitled to a replacement or refund for a major failure and for compensation for any other reasonably foreseeable loss or damage. You are also entitled to have the Appliance repaired or replaced if the Appliance fails to be of acceptable quality and the failure does not amount to a major failure. 'Acceptable quality' and 'major failure' have the same meaning as referred to in the ACL.

10. New Zealand: For Appliances and services provided by Electrolux in New Zealand, the Appliances come with a guarantee by Electrolux pursuant to the provisions of the Consumer Guarantees Act, the Sale of Goods Act and the Fair Trading Act. Where the Appliance was purchased in New Zealand for commercial purposes the Consumer Guarantee Act does not apply.

11. Confidentiality: You accept that if you make a warranty claim, Electrolux and its agents including ASC may exchange information in relation to you to enable Electrolux to meet its obligations under this warranty.

Important Notice

Before calling for service, please ensure that the steps listed in clause 8 above have been followed.

AUSTRALIA

FOR SERVICE

or to find the address of your nearest authorised service centre in Australia

PLEASE CALL 13 13 49

For the cost of a local call

FOR SPARE PARTS

or to find the address of your nearest spare parts centre in Australia

PLEASE CALL 13 13 50

For the cost of a local call

NEW ZEALAND

FOR SERVICE

or to find the address of your nearest authorised service centre in New Zealand

PLEASE CALL 0800 10 66 10

FOR SPARE PARTS

or to find the address of your nearest state spare parts centre in New Zealand

PLEASE CALL 0800 10 66 20

ECook_Warr_Jul19

15. ENVIRONMENTAL CONCERNS

Recycle materials with the symbol . Put the packaging in relevant containers to recycle it. Help protect the environment and human health by recycling waste of electrical and electronic appliances. Do not dispose of

appliances marked with the symbol  with the household waste. Return the product to your local recycling facility or contact your municipal office.

