



## MOMENTUM 4

Wireless around-ear headphones

Model: M4AEBT



Instruction manual

Use the search function, the navigation (left) or the following links:

Start

“Product overview”

“Getting started”

“Using the headphones”

“FAQ/If a problem occurs ...”

“Specifications”

Sonova Consumer Hearing GmbH

Am Labor 1

30900 Wedemark

Germany



[www.sennheiser-hearing.com](http://www.sennheiser-hearing.com)

Version: 12/22 A02

## Important safety instructions

- ▷ Read this instruction manual carefully and completely before using the product.
- ▷ Always include this instruction manual when passing the product on to third parties.
- ▷ Do not use the product if it is obviously defective or makes loud, unusual (whistling or beeping) noise.
- ▷ Only use the product in environments where **Bluetooth** wireless transmission is permitted.

### Preventing damage to health and accidents

- ▷ Protect your hearing from high volume levels. Permanent hearing damage may occur when headphones are used at high volume levels for long periods of time. Headphones of the Sennheiser brand sound exceptionally even good at low and medium volume levels. 
- ▷ The product generates stronger permanent magnetic fields that could cause interference with cardiac pacemakers, implanted defibrillators (ICDs) and other implants. Always maintain a distance of at least 3.94"/10 cm between the product component containing the magnet and the cardiac pacemaker, implanted defibrillator, or other implant. 
- ▷ Keep the product, accessories and packaging parts out of reach of children and pets to prevent accidents. Swallowing and choking hazard.
- ▷ Do not use the product in an environment that requires your special attention (e.g. in traffic). Especially the product's active noise cancellation can make ambient noise inaudible or drastically change the perception of acoustic warning signals.

### Preventing damage to the product and malfunctions

- ▷ Always keep the product dry and do not expose it to extreme temperatures (hairdryer, heater, extended exposure to sunlight, etc.) to avoid corrosion or deformation. The normal operating temperature is from 0 to 40 °C/32 to 104 °F.
- ▷ To avoid loud, unusual (whistling or beeping) noise and to ensure proper noise cancellation, do not cover the microphone openings of the active noise cancellation circuitry located on the outside of the ear cups.
- ▷ Use only attachments/accessories/spare parts supplied or recommended by Sonova Consumer Hearing.
- ▷ Clean the product only with a soft, dry cloth.

### Safety instructions for Lithium rechargeable batteries











---

#### WARNING

If abused or misused, rechargeable batteries may leak. In extreme cases, they may even present a risk of:

- explosion,
  - heat and fire development
  - smoke and/or gas development
  - damage to health and/or the environment
-

## Important safety instructions

	Only use rechargeable batteries and chargers recommended by Sonova Consumer Hearing.
	Do not leave the product / rechargeable batteries unattended while charging.
	Only charge the product / rechargeable batteries at ambient temperatures between 10 °C and 40 °C/50 °F and 104 °F and do not charge them near easily flammable objects.
	Do not charge the product / rechargeable batteries in a damp environment. Make sure that the charging socket is free from moisture and contamination.
	Do not heat the product / rechargeable batteries above 60 °C/140 °F. Avoid exposure to sunlight and do not throw the product / rechargeable batteries into fire.
	Switch rechargeable battery-powered products off after use.
	When not using the product / rechargeable batteries for extended periods of time, charge them regularly (about every three months).
	Avoid prolonged skin contact with the product, rechargeable battery, charger or charging cable when connected to a power source. These components can heat up during charging and cause skin irritation.
	Dispose of defective products with built-in rechargeable batteries at special collection points or return them to your specialist dealer to facilitate recycling.

### Notes on data collection and processing and on firmware updates

This product stores individual settings such as the volume, the sound profiles and the Bluetooth connection data of paired devices. This data is required for the operation of the product and is not transferred to Sonova Consumer Hearing GmbH or companies commissioned by Sonova Consumer Hearing GmbH and is not processed.

Using the “Sennheiser Smart Control” app, you can update the firmware of the product for free via an Internet connection. If the device on which the app is installed is connected to the Internet, the following data is automatically transferred to and processed by Sonova Consumer Hearing servers in order to provide and transfer suitable firmware updates: hardware identifier, hardware revision number, firmware version of the product, operating system type (Android, iOS) and version, version of the app. The data will only be used as specified and will not be stored permanently.

If you do not want this data to be transferred and processed, do not connect to the Internet.

### Notes on the use of headphones in damp environments

Headphones are an everyday companion. When using the headphones on the go, they may be exposed to moisture. For example, rain, air humidity or even sweat may come into contact with the headphones.

## Important safety instructions

To ensure proper, safe and long-lasting performance:

- ▷ Avoid contact with moisture and always keep headphones dry.
- ▷ Do not use headphones in the rain/snow or in the shower.
- ▷ Do not use headphones in swimming pool, sauna or during other activities with water/high air humidity (e.g. washing dishes).
- ▷ Do not store headphones in airtight containers/bags together with damp objects (e.g. damp laundry) or objects that can cause condensation moisture (e.g. cold water bottles).
- ▷ Never charge damp headphones. Make sure that the charging socket is free from moisture and contamination.

If your headphones have become damp or wet:

- ▷ Dry headphones completely with a dry cloth.
- ▷ Allow headphones to dry at room temperature for at least 24 hours before using and charging them again.
- ▷ Do not continue to use the product if it is obviously defective.

### Intended use/Liability

These headphones have been designed as an accessory for Bluetooth compliant devices. They are intended for wireless audio communication such as music playback and phone calls via Bluetooth wireless technology.

It is considered improper use when the product is used for any application not named in the corresponding product documentation.

Sonova Consumer Hearing GmbH does not accept liability for damage arising from misuse or improper use of this product and its attachments/accessories.

Sonova Consumer Hearing GmbH is not liable for damages to USB devices that are not consistent with the USB specifications.

Sonova Consumer Hearing GmbH is not liable for damages resulting from the loss of connection due to flat or overaged rechargeable batteries or exceeding the Bluetooth transmission range.

Before putting into operation, please observe the respective country-specific regulations.

## Package contents



MOMENTUM 4 around-ear headphones  
Model: M4AEBT

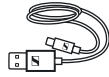

USB charging cable with USB-C and  
USB-A connector, length approx. 1.2 m



Analog audio cable with 3.5 mm jack plug and  
2.5 mm jack plug, length approx. 1.2 m



In-flight adapter

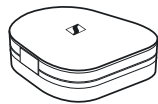

Carry case



Quick guide



Safety guide

Online you can find:

- this detailed instruction manual and additional information ([www.sennheiser-hearing.com/download](http://www.sennheiser-hearing.com/download))
- the Sennheiser Smart Control app for configuring the headphones and for additional functions ([www.sennheiser-hearing.com/smartcontrol](http://www.sennheiser-hearing.com/smartcontrol))
- a list of accessories on the MOMENTUM 4 product page at [www.sennheiser-hearing.com/momentum-4-wireless](http://www.sennheiser-hearing.com/momentum-4-wireless) (to purchase online or contact your local Sonova Consumer Hearing partner: [www.sennheiser-hearing.com/service-support](http://www.sennheiser-hearing.com/service-support))

# Product overview

MOMENTUM 4

Model: M4AEBT

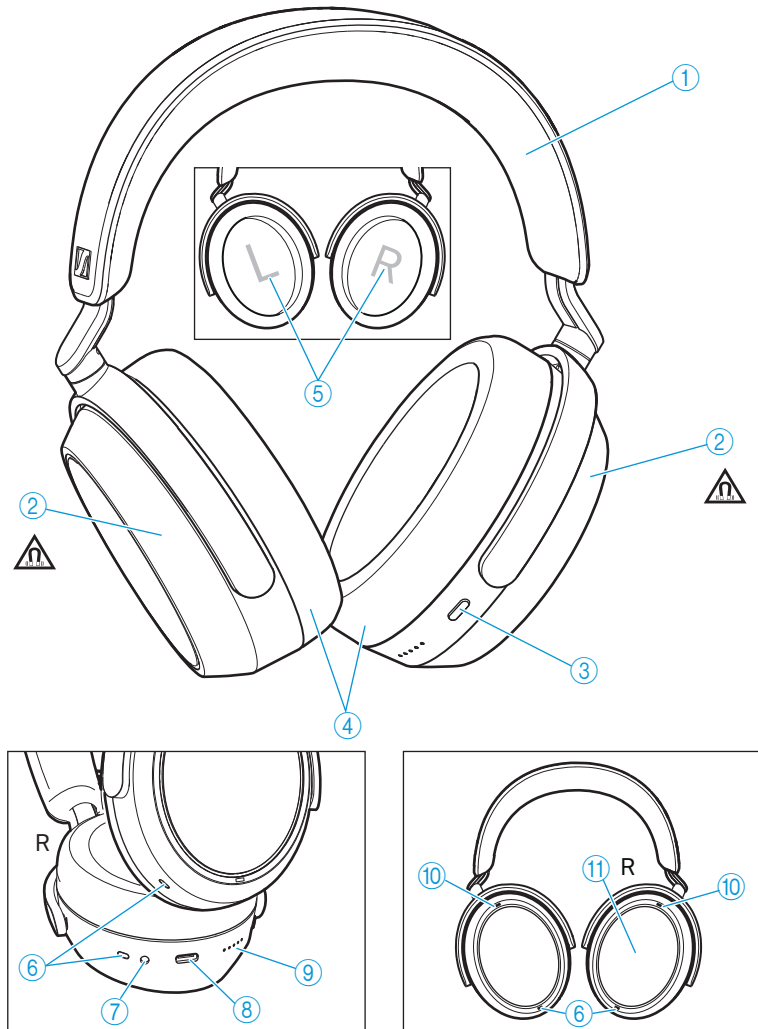

- ① Headband, steplessly adjustable
- ② Ear cups
- ③ Multi-function button of the headphones:
  - On/off button
  - Voice assistant button
  - Pairing button: pressing for 5 seconds activates the Bluetooth pairing mode
- ④ Ear pads
- ⑤ Marking for the right ear (R) and for the left ear (L) (inside the ear cups)
- ⑥ Speech microphones (4 pcs.) for phone calls
- ⑦ Input for analog audio cable, 2.5 mm; when a cable is connected, flight mode is activated/Bluetooth is deactivated
- ⑧ USB-C socket for charging, calling, streaming via PC/Mac

## Product overview

- ⑨ LED display
- ⑩ Microphones for active noise cancellation ANC:  
2x directed outward, 2x directed inward (not visible)
- ⑪ Touch pad (outside of the right ear cup)

### Overview of the smart control

#### Switch-on of the headphones

- Automatic switch-on: by lifting and putting on

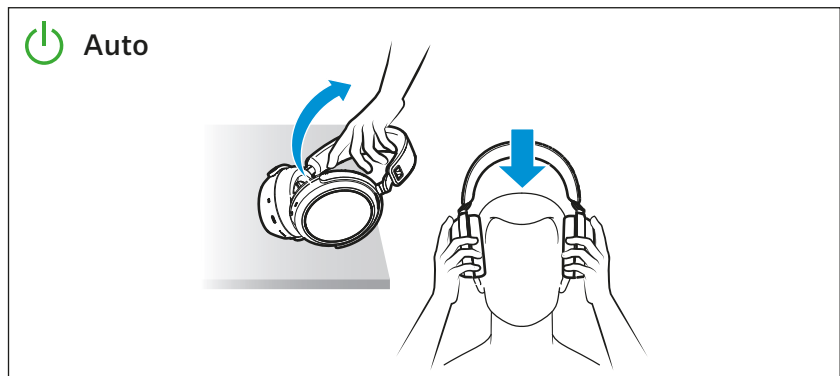

- Manual switch-on: by pressing the multi-function button for 3 seconds

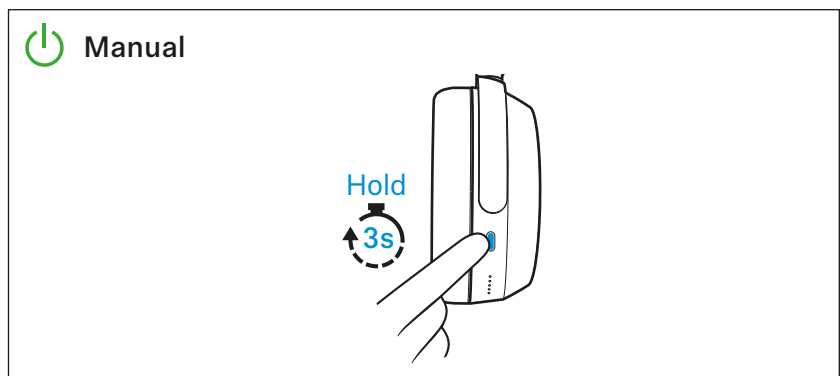

### Gesture control via the touch pad

- Tap

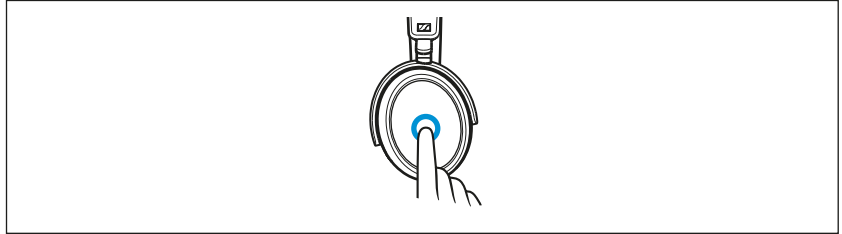

- Horizontal swipe

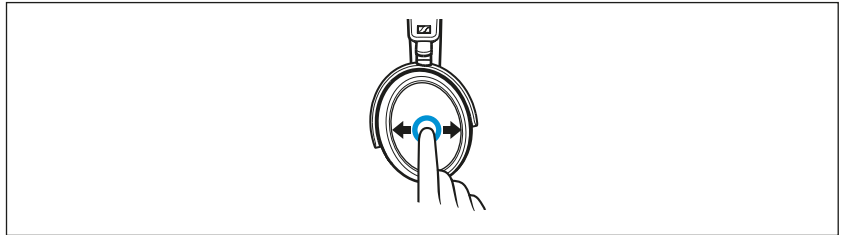

- Vertical swipe

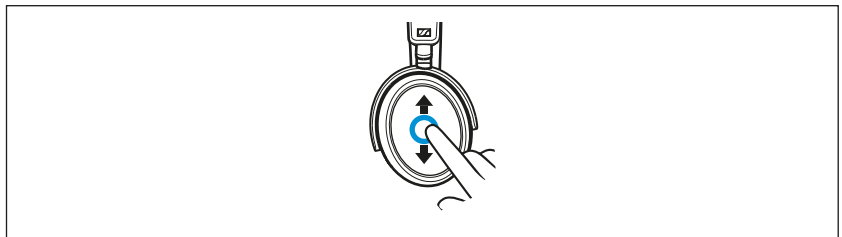

- Stretch

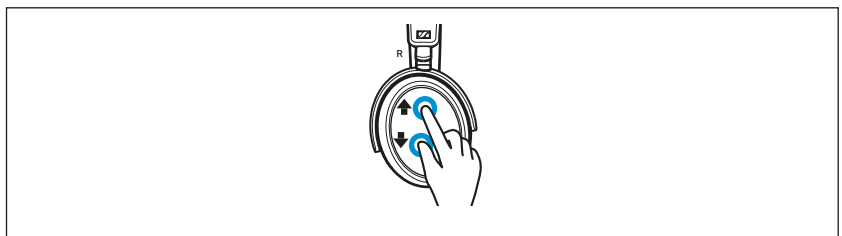

- Pinch

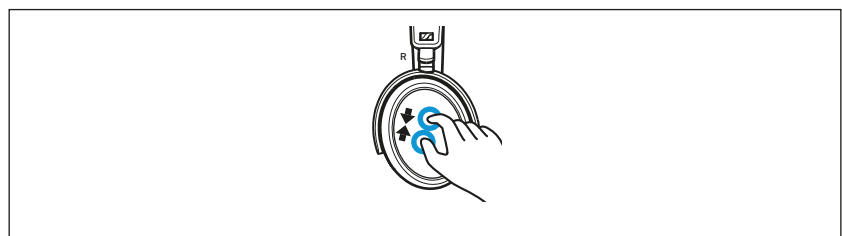



**i** You can also deactivate the touch pad function, see: > 34.

**i** The headphones are equipped with a sensor that automatically detects whether the headphones are worn or taken off from your ears (Smart Pause function). You can find more information here: > 33.

## Overview of the LED display





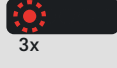

### During operation

LED		Meaning/headphones...
	white flashes 3x	... switch on ... are connected to a device via Bluetooth
	white continuous sequence	... are in Bluetooth pairing mode
	red flashes 3x	... switch off

### During phone calls

LED		Meaning
	white flashes 3x repeatedly	Incoming call
	red flashes 3x repeatedly	Incoming call with an almost empty battery

### During charging

LED		Meaning
	1 red	Rechargeable battery is almost empty (less than 2% charged)
	1 white	Rechargeable battery is approx. 2-20% charged (>1 hour of playback time)
	2 white	Rechargeable battery is approx. 20-40% charged (>12 hours of playback time)
	3 white	Rechargeable battery is approx. 40-60% charged (>24 hours of playback time)
	4 white	Rechargeable battery is approx. 60-80% charged (>36 hours of playback time)
	5 white	Rechargeable battery is approx. 80-100% charged (>48 hours of playback time)
	5 white	Rechargeable battery is 100% charged (up to 60 hours of playback time)



If the LED display does not light up:

- Clean the charging socket (> 38).
- Charge the rechargeable battery until the LED display lights up again (at least 30 minutes) (> 14). If the rechargeable battery is completely discharged, it may take several minutes for the LED display to indicate the charging process.

### Overview of sound signals and voice prompts

The headphones output voice prompts and sound signals in case of various events.

 Via the Smart Control app, you can adjust settings for the voice prompts and sound signals (> 34).

Voice prompt	Meaning/headphones...
<b>Establishing a Bluetooth connection</b>	
“Connected”	...are connected via Bluetooth.
“No connection”	... have lost the Bluetooth connection to a paired device.
“Pairing successful”	... have successfully completed Bluetooth pairing.
“Pairing failed”	... have not successfully completed Bluetooth pairing.
<b>Information on battery status and volume</b>	
“Recharge headset”	... has an empty rechargeable battery. Charge the rechargeable battery (> 14).
“More than xx % battery left”	... indicates the remaining battery charge in percent.
“Volume min”	... has reached the minimum volume setting.
“Volume max”	... has reached the maximum volume setting.
“Mute on”	... mutes the microphone.
“Mute off”	... activates the microphone again.

You hear short sound signals when the headphones

- are switched on or off,
- are put on or taken off,
- are in pairing mode (melody),
- detect devices in the pairing list,
- cancel the pairing process,
- receive a gesture via the touch pad (increasing the volume, starting/pausing music playback, answering/holding/rejecting calls, adjusting the ANC function or Transparency Mode),
- receive an incoming call (ring tone),
- are connected to a device via the audio cable or USB cable,
- are disconnected from the connection via the audio cable or USB cable.

# Getting started

## 1. Charging the rechargeable battery

The headphones' rechargeable battery is not fully charged upon delivery.

- ▷ Before using the headphones for the first time, charge the rechargeable battery for a complete charging cycle without interruption (> 14).

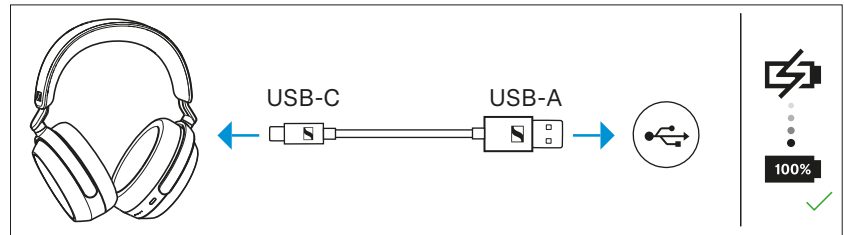

## 2. Connecting the headphones to a Bluetooth device

- ▷ Connect the headphones to your smartphone via Bluetooth (> 15).



## 3. Smart Control app for your smartphone

The Sennheiser Smart Control app allows you to use all functions and settings of the headphones and to e.g. adjust the sound to your liking using the equalizer (> 19).

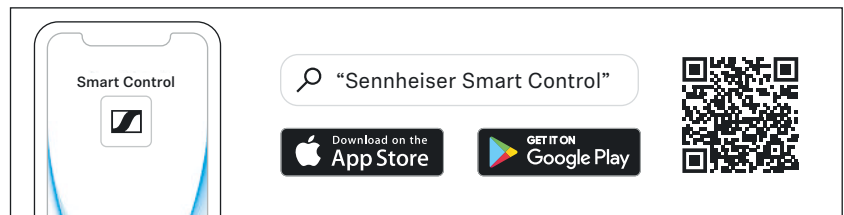

#### 4. Putting the headphones on and adjusting the headband

For good sound quality and best possible wearing comfort, the headband can be adjusted to properly fit your head (> 21).

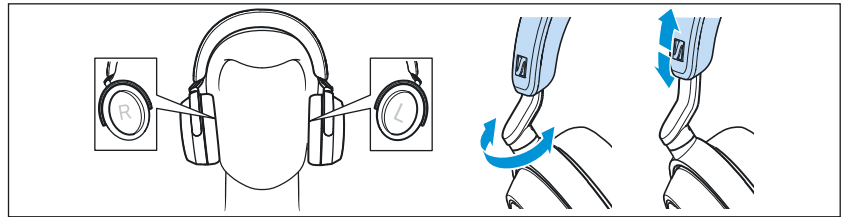

## Using the headphones

### Information on the rechargeable battery and the charging process

The headphones have a built-in rechargeable battery. A complete charging cycle takes approx. 2 hours. The charging time may vary depending on the power source used and the ambient temperature. Before using the headphones for the first time, charge the rechargeable battery for a complete charging cycle without interruption.

When the headphones are being charged, the LED display lights up (>9). Once the headphones are fully charged, the LEDs flash white for approx. 5 minutes and then go off. When the battery charge drops to a low level, the voice prompt “Recharge headset” asks you to recharge the headphones. If the headphones are not charged, the voice prompt will be repeated every 10 minutes until the headphones switch off.

Sonova Consumer Hearing recommends using the supplied USB cable and a compatible standard USB power supply for charging the headphones.

While the headphones are being charged, you can still listen to music or make phone calls. In this case, however, the charging time may be longer.





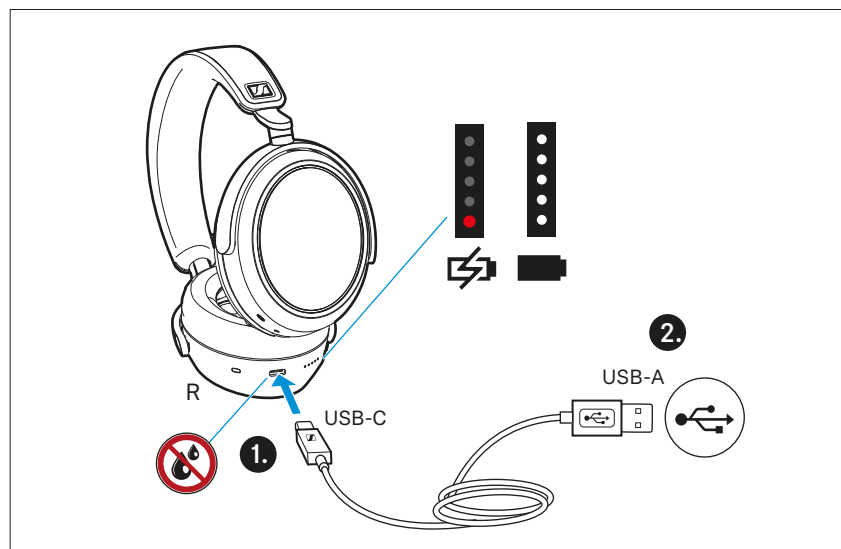

At the end of its operational lifetime, this product with its built-in rechargeable battery must be disposed of separately from normal household waste. You can find more information here: > 43.

### Charging the headphones' rechargeable battery



1. Make sure that the charging socket is free from moisture and contamination. Connect the USB-C connector of the charging cable to the USB socket of the headphones.

2. Connect the USB-A connector to a corresponding socket of a USB power source (to be ordered separately). Make sure that the USB power source is connected to the power supply system. The charging process of the headphones begins. The LED display indicates the charge status.

LED		Meaning
	1 red	Rechargeable battery is almost empty (less than 2% charged)
	1 white	Rechargeable battery is approx. 2-20% charged (>1 hour of playback time)
	2 white	Rechargeable battery is approx. 20-40% charged (>12 hours of playback time)
	3 white	Rechargeable battery is approx. 40-60% charged (>24 hours of playback time)
	4 white	Rechargeable battery is approx. 60-80% charged (>36 hours of playback time)
	5 white	Rechargeable battery is approx. 80-100% charged (>48 hours of playback time)
	5 white	Rechargeable battery is 100% charged (up to 60 hours of playback time)

If the LED display does not light up:

- ▷ Clean the charging socket (> 38).
- ▷ Charge the rechargeable battery until the LED display lights up again (at least 30 minutes) (> 14). If the rechargeable battery is completely discharged, it may take several minutes for the LED display to indicate the charging process.

**i** You can speed up the charging process by charging the headphones when they are switched off.

**i** If you disconnect the USB connection during or after charging, you will hear a voice prompt informing you of the remaining battery life.

## Connecting the headphones to a Bluetooth device

To be able to use the Bluetooth connection, you must register both devices (headphones and e.g. smartphone) once. This process is called pairing.

If operation differs from the steps mentioned, also refer to the instruction manual of the Bluetooth device you are using.

**i** If you switch on the headphones for the first time (the pairing list is empty), they automatically switch to pairing mode.

## Information on the Bluetooth wireless connection

The headphones are compliant with Bluetooth 5.2.

If your audio source supports one of the following high-resolution audio encoding methods, music is automatically played in high audio quality: aptX™ Adaptive (aptX™, aptX™ Low Latency) or AAC. Otherwise the headphones will play your music in normal audio quality (SBC).

Paired devices establish the Bluetooth wireless connection immediately after switch-on and are ready for use.

On switch-on, the headphones automatically try to connect to the last two connected Bluetooth devices. The headphones can save the connection profiles of up to six Bluetooth devices with which they have been paired. Audio playback is only possible from one device at a time.

If you pair the headphones with the seventh Bluetooth device, the saved connection profile of the least used Bluetooth device will be overwritten. If you want to re-establish a connection with the overwritten Bluetooth device, you have to pair the headphones again.

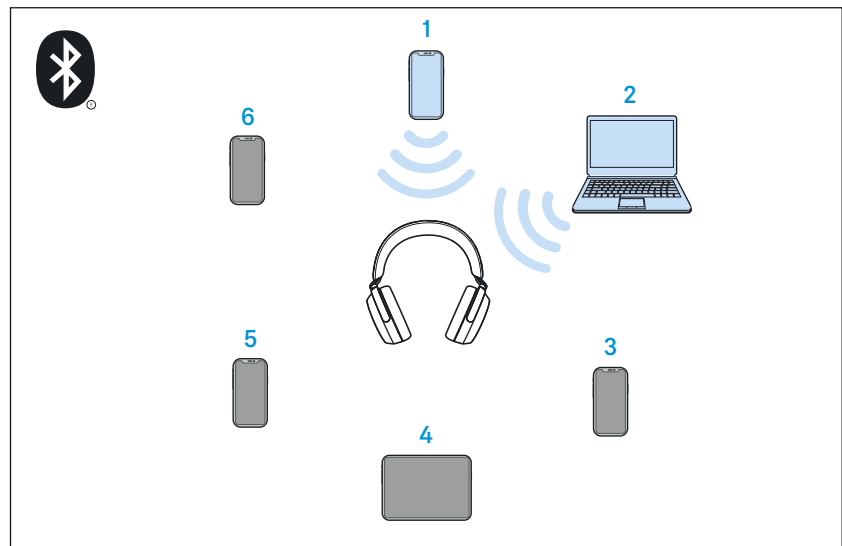

Paired and connected Bluetooth device



Paired Bluetooth device (currently not connected)

## Pairing the headphones with a Bluetooth device

**i** If you switch on the headphones for the first time (the pairing list is empty), they automatically switch to pairing mode.

1. Switch the headphones off and place them close to the Bluetooth device (max. 20 cm).
2. Press the multi-function button for 5 seconds.  
The headphones are switched on and you hear a sound signal.  
The LEDs light up white 3x.  
The headphones switch to pairing mode. The LEDs light up as a white continuous sequence and a melody can be heard.
3. Activate Bluetooth on your Bluetooth device.
4. Via the menu of your Bluetooth device, start the search for new Bluetooth devices.  
All active Bluetooth devices in the proximity of your Bluetooth device are displayed.

**i** By default, the name of the headphones is “MOMENTUM 4”.  
You can individually adjust the name in the Smart Control app (> 19).

5. From the list of found Bluetooth devices, select “MOMENTUM 4”.  
If necessary, enter the default pin code “0000”.
6. If pairing was successful, you hear the voice prompts “Pairing successful” and “Connected” one after the other. The LED flashes white 3x.

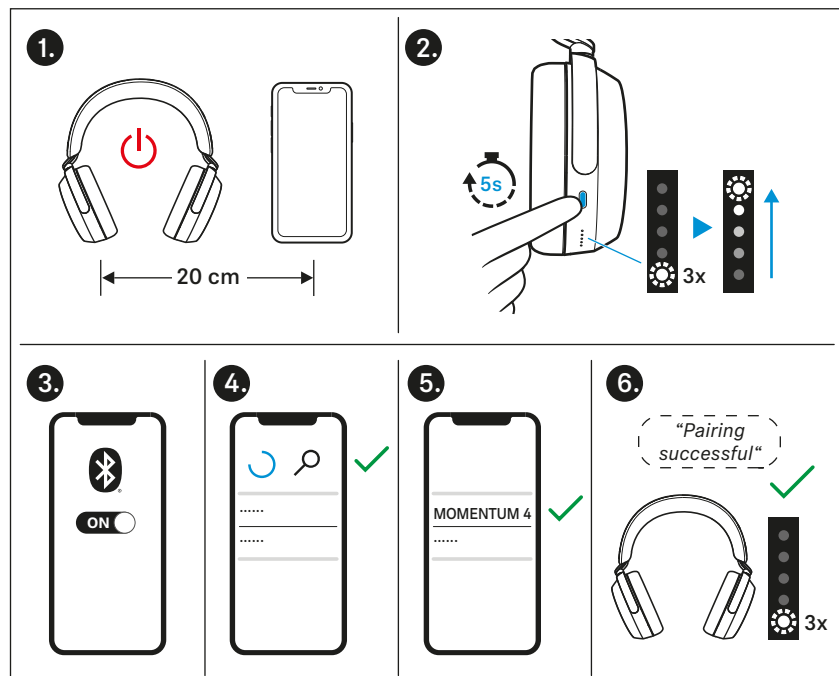

**i** If no connection is established within 2 minutes, pairing mode is terminated and the headphones switch to standby mode. If necessary, repeat the steps described above.

## Switching the connection to paired Bluetooth devices/“Connections”

To selectively switch the audio connection to paired Bluetooth devices using the “Connections” function, you require the Smart Control app (> 19).

- ▷ In the Smart Control app, tap “Connections”.  
The list of Bluetooth devices paired with the headphones appears.
- ▷ From the list, select the paired device to which you want to connect the headphones. Make sure that the desired device is switched on and Bluetooth is activated.  
The Bluetooth audio connection between the desired Bluetooth device and the headphones is established.  
The app connection between the device with the Smart Control app installed and the headphones remains active (only Bluetooth Low Energy for communication between app and headphones, the device name is highlighted in bold).

**i** The “Connections” function also allows you to selectively delete pairing information of devices without resetting the headphones to the factory default settings.

## Disconnecting the headphones from a Bluetooth device

- ▷ Via the menu of your Bluetooth device, disconnect the connection to the headphones.  
The headphones are disconnected from the Bluetooth device. You hear the voice prompt “No connection”. The headphones switch to standby mode.

**i** To delete the Bluetooth pairing list of the headphones: > 41.

## Installing the Smart Control app

To make full use of all the settings and functions of the headphones, you need to have the free Sennheiser Smart Control app installed on your smartphone.

Download the app from the Apple App Store or Google Play and install it on your smartphone. Alternatively, you can use your smartphone to scan the following QR code or to call up the following Internet site:

[www.sennheiser-hearing.com/smartcontrol](http://www.sennheiser-hearing.com/smartcontrol)

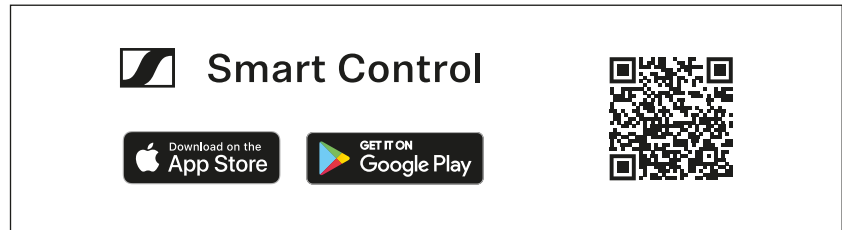

- ▷ Connect your smartphone to the headphones via Bluetooth (> 15).
- ▷ Start the Smart Control app.
- ▷ Follow the instructions in the app.  
The Smart Control app recognizes the headphones and activates all available settings and functions.

## Switching the headphones on



### WARNING

**Danger of hearing damage due to high volume levels!**

Listening at high volume levels can lead to permanent hearing defects.

- ▷ Before putting the headphones on, adjust the volume to a low level (> 22).
- ▷ Do not continuously expose yourself to high volume levels.

### Automatic switch-on

- ▷ When the headphones are in the supplied carry case: Take out the headphones from the carry case.  
One LED flashes white 3x. The headphones automatically switch on.
- ▷ Put on the headphones.  
You hear a sound signal. If Bluetooth is activated on the headphones and a paired device is available, you hear the voice prompt "Connected".  
If Bluetooth is deactivated on the headphones (> 35), you only hear a sound signal. The active noise cancellation ANC may be activated (> 26).

### Manual switch-on

- ▷ Press the multi-function button for 3 seconds.  
One LED flashes white 3x. You hear a sound signal. If Bluetooth is activated on the headphones and a paired device is available, the LED lights up white and you hear the voice prompt “Connected”.  
If Bluetooth is deactivated on the headphones (> 35), you only hear a sound signal. The active noise cancellation may be activated (> 26).

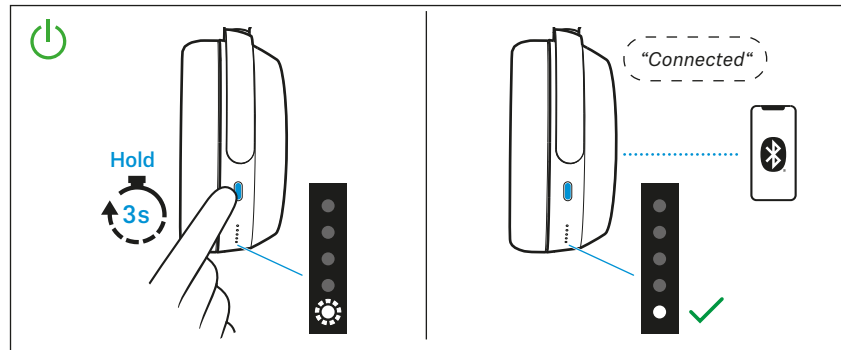

- i** Make sure that Bluetooth is already activated on your Bluetooth device when switching on the headphones.
- i** If Bluetooth is activated and the headphones cannot find a paired Bluetooth device within a few minutes, you hear the voice prompt “No connection”. The LED flashes red 3x. The headphones switch to standby mode.

## Switching the headphones off

### Automatic switch-off

After taking off the headphones, they automatically switch off after 15 minutes. You can adjust the time span using the Smart Control app (> 19).

After being placed in the supplied carry case, the headphones immediately switch off automatically.

### Manual switch-off

- ▷ Press the multi-function button for 3 seconds.  
You hear a sound signal. One LED flashes red 3x. The headphones switch off.

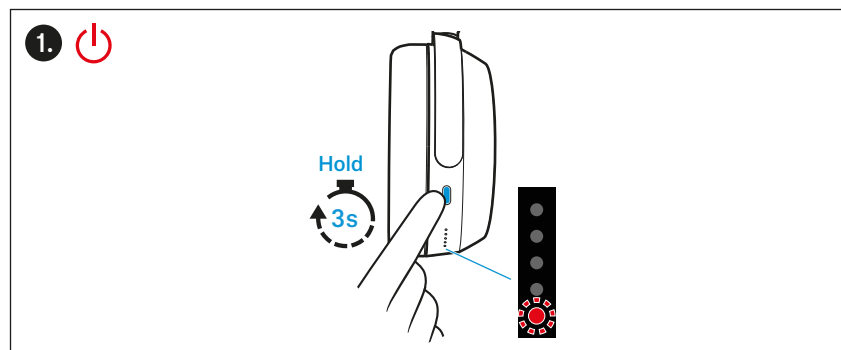

## Putting the headphones on and adjusting the headband

For good sound quality, the best possible noise cancellation and the best possible wearing comfort, the headband can be adjusted to properly fit your head.

- ▷ Wear the headphones so that the headband runs over the top of your head. The markings for the right side (R) and for the left side (L) can be found on the inside of the ear cups.
- ▷ Move the ear cups up or down the headband slider until:
  - your ears are comfortably covered by the ear pads,
  - you feel even, gentle pressure around your ears,
  - a snug fit of the headband on the head is ensured.

For optimal sound quality, the ear pads must completely surround your ears.

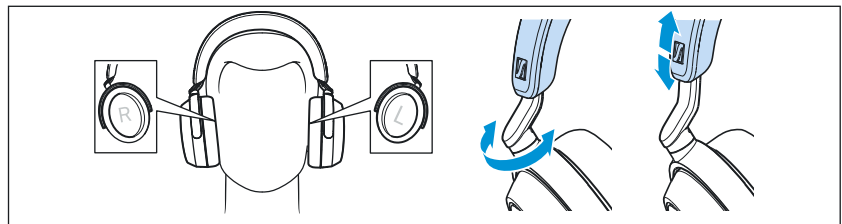

## Retrieving information on the battery charge status

When the headphones are connected to your Bluetooth device, the battery charge status can be displayed on the screen of your smart-phone (depending on the device and operating system used).

The Smart Control app also displays the battery charge status.

On the headphones, you can retrieve information on the battery charge level via the voice prompts (also possible while listening to music or talking on the phone, as long as you have the headphones on):

- ▷ Press the multi-function button 2x.

You hear a voice prompt informing you of the remaining battery life. Depending on the battery life of the headphones, the LEDs flash or light up.

Voice prompt	Meaning
“Recharge headset”	The rechargeable battery is empty. Charge the rechargeable battery (> 14).
“More than xx % battery left”	The remaining battery charge is displayed as a percentage.

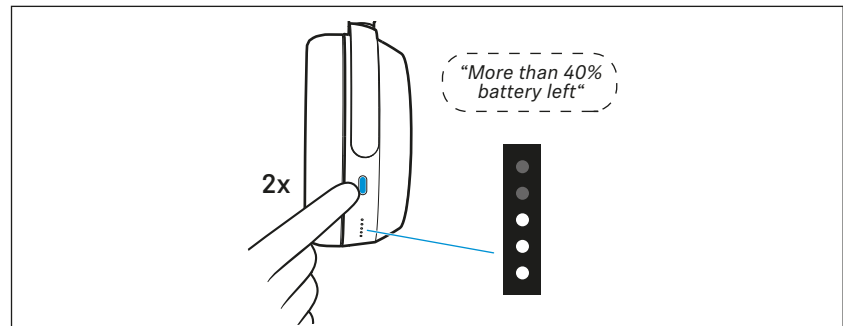

## Adjusting the volume



### WARNING

**Danger of hearing damage due to high volume levels!**

Listening at high volume levels can lead to permanent hearing defects. Toggling between the audio sources may cause enormous volume jumps that can permanently damage your hearing.

- ▷ Before putting the headphones on and before toggling between audio sources, adjust the volume to a low level.
- ▷ Do not continuously expose yourself to high volume levels.

You can adjust the playback volume for music and for phone calls.

- ▷ If you are playing music, are on a call or if the headphones are in idle mode (i.e. you are neither playing music nor are on a call):  
Swipe vertically up or down on the touch pad to increase or reduce the volume for music, voice prompts and sound signals.

When the maximum or minimum volume is reached, you hear the voice prompt “Volume max” or “Volume min”.

## Using the headphones

Depending on the length of the swipe motion, you adjust the volume in smaller increments (short swipe motion) or larger increments (long swipe motion).

When switching the headphones off, very high volume levels are automatically reset to a moderate level to protect your hearing when you switch the headphones on again.

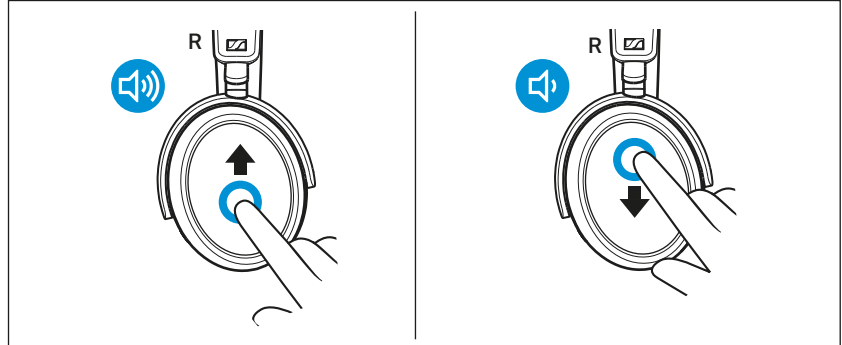

**i** You can also adjust the volume using the connected Bluetooth device.

**i** If you have activated the voice assistant (> 32) and then change the volume of the headphones, the volume of the voice assistant is adjusted accordingly and saved permanently.

## Information on active noise cancellation ANC

Due to its closed design, the headphones offer effective passive isolation from ambient noise.

In addition, the headphones have an active noise cancellation (ANC) function, which allows you to reduce ambient noise to a minimum.

Even when ANC is activated, your headphones' sound quality is always at its best.

You can activate or deactivate ANC when the headphones are connected to your audio source via Bluetooth or via the audio cable/USB cable (provided that the battery is sufficiently charged).

If you want to create a quiet space in a noisy environment, you can simply use the headphones – without connected cables and without Bluetooth devices – as noise protection by using ANC (> 26).

With the Smart Control app, you can select different ANC modes that provide the optimal settings for your application/situation.

### Notes on active noise cancellation

- Continuous and low-frequency noise, such as motor or fan noise, is particularly well suppressed.
- Speech or high-frequency noise is significantly reduced, but can remain perceptible.
- In very quiet environments, slight noise may occur. In this case, deactivate ANC.
- If unusual (whistling or beeping) noise occurs, take the headphones off and put them on again. Make sure that the ear cups properly fit around your ears.
- To avoid loud, unusual (whistling or beeping) noise and to ensure proper noise cancellation, do not cover the microphone openings of the active noise cancellation circuitry located on the outside of the ear cups.



## Information on the Transparency Mode – Hearing ambient sounds or conversations

With the Transparency Mode activated, you can hear ambient sounds or communicate without having to remove the headphones. This allows you to hear e.g. announcements in the train or aircraft or to have short conversations.

The Transparency Mode optimally complements the active noise cancellation ANC. Via the adjustable intensity of the Transparency Mode and the active noise cancellation ANC, you can determine how much ambient noise reaches your ears or whether you want to listen exclusively to your music (ANC at full intensity).

If you use the Transparency Mode at full intensity, disturbing sounds, e.g. low-frequency noise such as aircraft noise, are always suppressed so that you can stay relaxed and in touch with your surroundings.

## Switching between the active noise cancellation ANC and the Transparency Mode

You can use the gesture control on the touch pad to switch between the active noise cancellation ANC and the Transparency Mode, e.g. if you want to transition from ambient awareness to idle mode as quickly as possible.

This function is not available during an active call, see: > 29.

▷ To switch between the modes, tap the touch pad 2x.

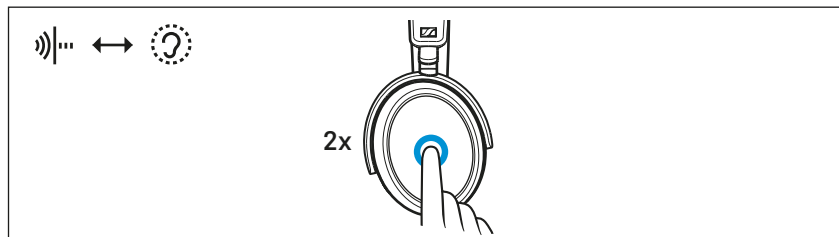

**i** The intensity of the Transparency Mode and the active noise cancellation remains incrementally adjustable (> 26).

## Adjusting the playback pause in Transparency Mode

You can select the behavior of the audio playback, i.e. how it behaves at maximum intensity of the Transparency Mode (tap the touch pad 2x). To be able to adjust this setting, you require the Smart Control app (> 19).

▷ In the Smart Control app, select the desired Transparency Mode function in the “Active Noise Cancellation” section:

“Pause on full transparency”	Description
activated*	Audio playback (e.g. music) is muted and you hear only ambient sounds.
deactivated	Audio playback (e.g. music) continues and is mixed with ambient sounds.

\*default setting

## Increasing/decreasing the active noise cancellation ANC and the Transparency Mode

To increase the active noise cancellation ANC and decrease the Transparency Mode:

- ▷ On the touch pad, move your thumb and index finger towards each other.  
You hear a sound signal. The intensity of the ANC is increased and ambient awareness is decreased.

To increase the Transparency Mode and decrease the active noise cancellation ANC:

- ▷ On the touch pad, move your thumb and index finger away from each other.  
You hear a sound signal. The intensity of the ambient awareness is increased and the ANC is decreased.

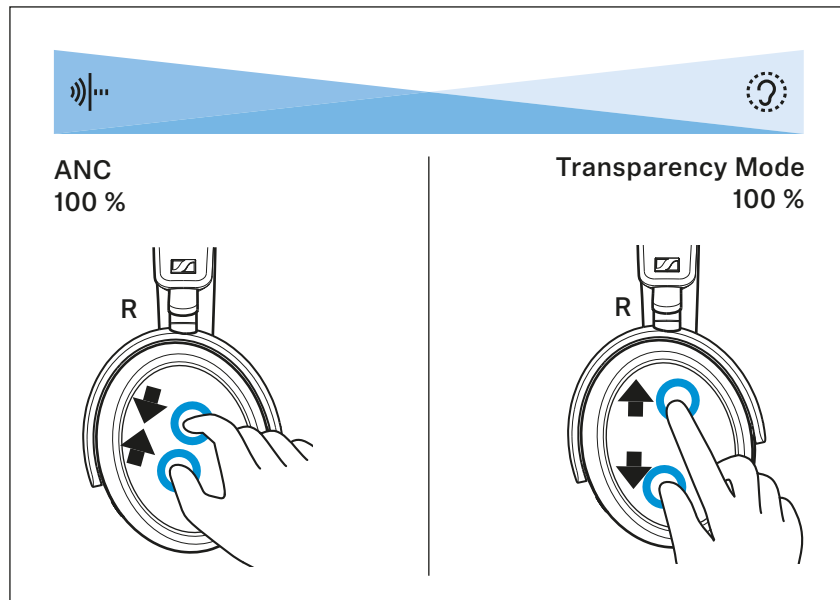

**i** You can also adjust the intensity of the active noise cancellation ANC and the Transparency Mode via a slider in the Smart Control app.

## Adjusting the active noise cancellation ANC

To be able to adjust settings for the active noise cancellation ANC, you require the Smart Control app (> 19).

- ▷ Select the desired setting in the “Active Noise Cancellation” section of the Smart Control app:

ANC setting	Reduction of low-frequency noise and background noise
<b>“Adaptive”</b>	
activated*	automatic reduction depending on the noise conditions

## Using the headphones

ANC setting	Reduction of low-frequency noise and background noise
deactivated	No automatic reduction
<b>“Wind Noise Reduction”</b>	
Off	Wind noise reduction off
Auto*	Automatically adjusted reduction to minimize disturbing wind or movement noise
Max	Maximum wind noise reduction

\*default setting

## Listening to music using the headphones

You can listen to music when the headphones and your audio source are connected via Bluetooth (> 15), the audio cable (> 36) or via USB (> 37).

## Controlling music playback

The following music functions are only available when the headphones and the device are connected via Bluetooth or USB. Some smartphones or music players may not support all functions.

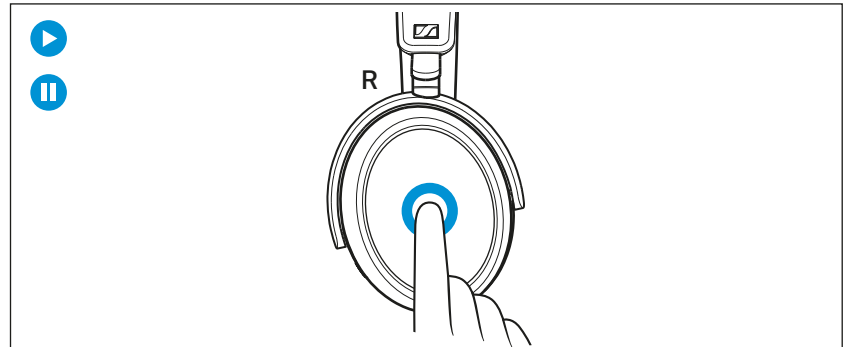

▷ Tap the touch pad.

Touch gesture		Function
	Tap 1x	Plays or pauses music
	Tap 2x	Pauses music and switches to idle mode (intensity of the Transparency Mode remains adjustable: > 26)







If music playback does not start:

- Check if the playback pause is activated in the Transparency Mode (> 25) and deactivate the function if necessary.
- Start the music playback app on your Bluetooth device.

### Playing the next/previous track

▷ Swipe horizontally on the touch pad.

Touch gesture		Function
	Swipe forward	Plays the next track in the playlist
	Swipe forward and hold	*Fast-forwards a track
	Swipe backward	Plays the previous track in the playlist
	Swipe backward and hold	*Rewinds a track

\* only for smartphones or music players that support this function

## Making phone calls using the headphones

The following call functions are only available when the headphones, the smartphone or the PC/Mac are connected via Bluetooth (> 15). Some smartphones or communication apps may not support all functions. During a call, the active noise cancellation ANC is always activated to ensure the best possible speech intelligibility. The Transparency Mode cannot be used.

**i** If the headphones are switched off during an active call or if the rechargeable battery is empty, the call is put on hold and you can use your smartphone as an output device as usual.

### Making a call

▷ Dial the desired number on your smartphone.

If your smartphone does not automatically transfer the call to the headphones, select “MOMENTUM 4” as the output device on your smartphone (see the instruction manual of your smartphone if necessary).

### Accepting/rejecting/ending a call

If your headphones are connected to a smartphone and you receive a call, you hear a ring tone in the headphones.

If you are playing music when you receive a call, the music pauses until you end the call.

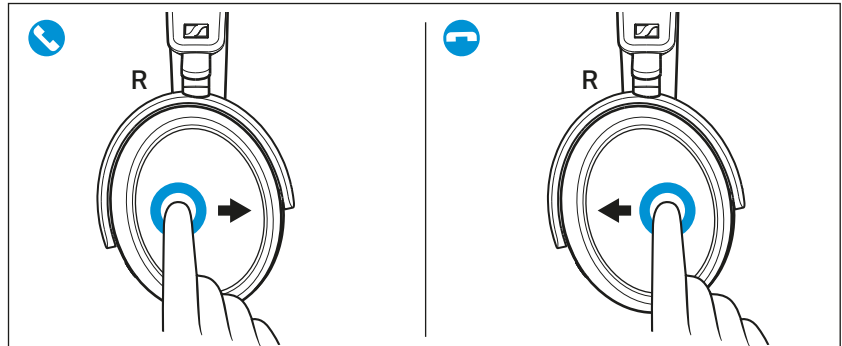

▷ Use the touch pad:

Touch gesture		Function
	Swipe forward	Accepts a call
		Accepts an incoming call and ends the active call
	Swipe backward	Ends a call
 2sec	Hold for 2 seconds	Rejects a call
		Rejects an incoming call and ends the active call
 2x	Tap 2x	Puts an active call on hold
		Accepts an incoming call and puts the active call on hold
		Toggles between active call and call on hold

### Muting the microphone

To mute the headphones' microphone during a call:

- ▷ Press the multi-function button 1x.  
You hear the voice prompt "Mute on". The microphone is muted.

To activate the microphone again:

- ▷ Press the multi-function button 1x.  
You hear the voice prompt "Mute off". The microphone is reactivated.

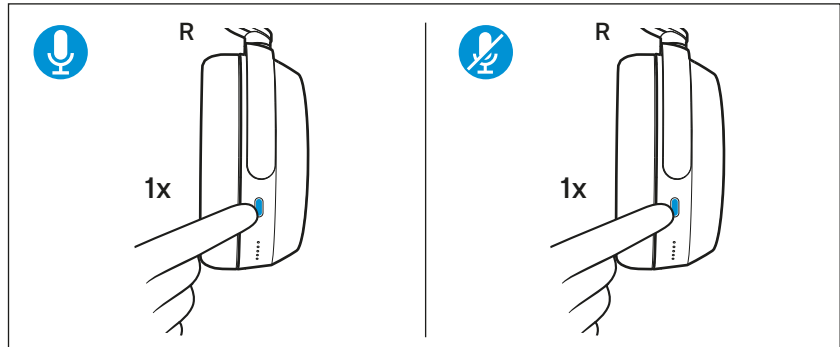

### Using the Sidetone function

When using the headphones for phone calls, you may find it more comfortable if your own voice is audible in the headphones. With the Sidetone function activated, your own voice is played back through the headphones during a phone call.

Via the Smart Control app, you can activate the function (default setting) and adjust the intensity via a slider or deactivate the function.

## Using the voice assistant/voice dialing

The voice assistant is only available when the headphones and the mobile device are connected via Bluetooth or USB. Some smart-phones or music players may not support all functions.

- ▷ Press the multi-function button 1x.  
The available voice assistant of your mobile device is activated (depending on the system used or app installed on your mobile device: Siri, Google Assistant or others. If no voice assistant is available, voice dialing may be activated).
- ▷ Speak your request.

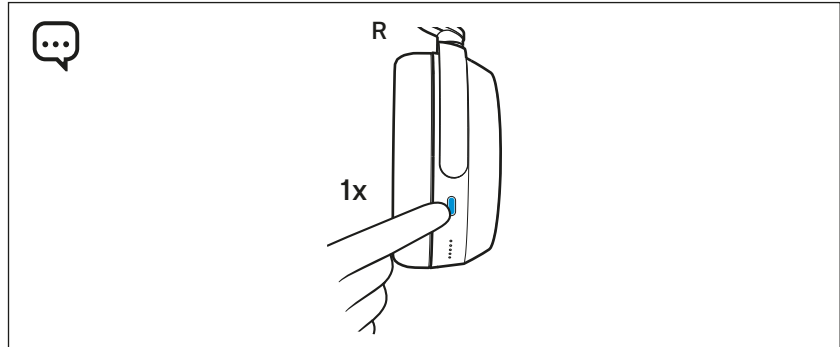

To cancel the voice assistant or voice dialing:

- ▷ Press the multi-function button 1x.

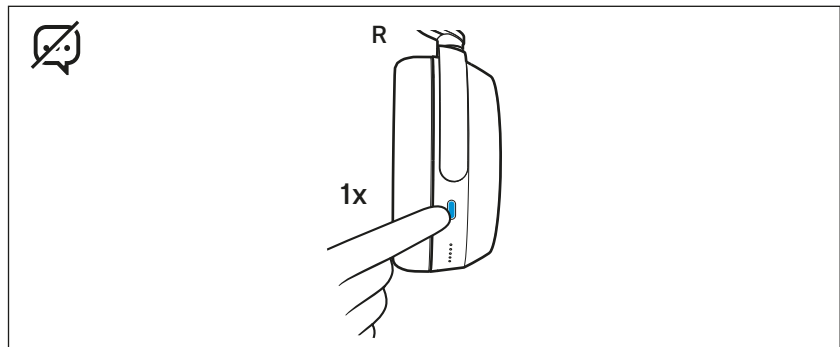

## Using the Smart Pause function

The headphones are equipped with a sensor that automatically detects whether the headphones are worn or taken off from your ears.

You can use the following functions:

- Music playback pauses when you take off the headphones and continues when you put them on again.
- A phone call is accepted when you put on the headphones.
- A phone call is muted when you take off the headphones during the call and resumed when you put the headphones back on.

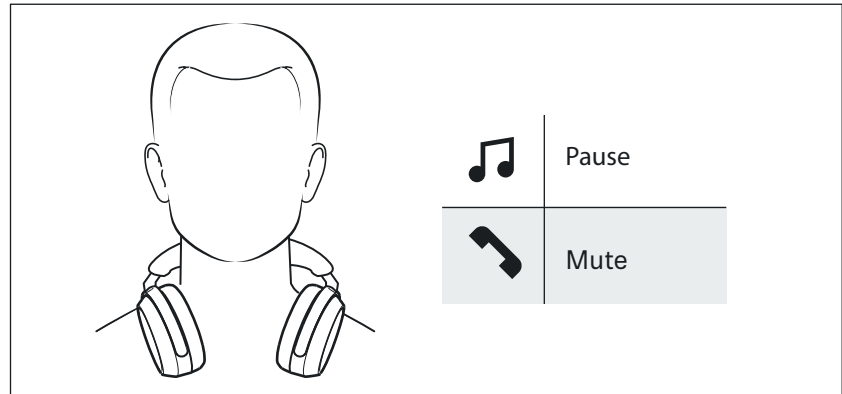

If you take off the headphones and transport them or put them down when they are switched on, the sensor will not detect that the headphones have already been taken off in certain situations, e.g.:

- If you place the insides of the ear cups facing down on a table.
- If you wear the headphones around your neck and your chin covers the area inside the ear cups.
- If the insides of the ear cups are covered by objects or by your hands.
- If you hang the headphones over the edge of a bag or carry them inside a bag.
- If you wear the headphones over a cap, scarf, or over your hair.

To avoid problems with the sensor:

- ▷ Store the headphones in the supplied carry case (> 37).
- ▷ Switch off the headphones manually when you store them outside the carry case (> 20).



You can deactivate the sensor function via the Smart Control app. The smart functions such as automatic switch-off of the headphones when placed in the carry case or muting when the headphones are taken off are then no longer available.

## Adjusting sound effects/the equalizer

To be able to use the sound effects/the equalizer, you require the Smart Control app (> 19).

- ▷ In the Smart Control app, select the desired sound effects via the equalizer. You can use predefined presets, define sound modes (e.g. bass boost) or define your own settings. The sound effects are stored in the headphones. These sound settings are active even without using the Smart Control app, i.e. when you are using a different Bluetooth device.

**i** The Sound Check function of the Smart Control app allows you to create customized equalizer presets. Sound Check guides you step by step to the optimal result.

## Setting the voice prompts/sound signals

To be able to set the voice prompts and sound signals, you require the Smart Control app (> 19).

In the app settings, you can activate voice prompts and sound signals (default setting) or deactivate them completely.

## Deactivating the touch pad function

To avoid unintentional entries via the touch pad of the headphones, e.g. when you have put the headphones on while lying down, you can deactivate the touch pad function. To do this, use the Smart Control app (> 19).

## Deactivating Bluetooth/activating flight mode

Deactivate the Bluetooth wireless connection when wireless connections are not allowed, such as on an aircraft during take-off and landing.

The active noise cancellation ANC can be fully used provided that the rechargeable battery is charged (> 26).

To deactivate the Bluetooth wireless connection and activate flight mode:

- ▷ Press the multi-function button 5x. You hear the voice prompt “No connection”. The Bluetooth wireless connection is deactivated.

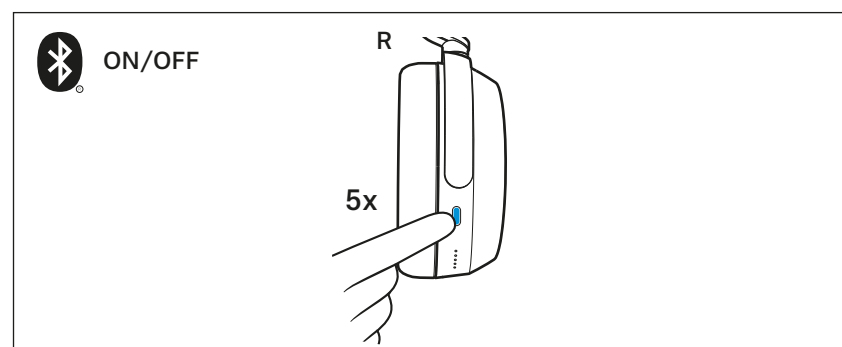

To activate the Bluetooth wireless connection again:

- ▷ Press the multi-function button 5x.  
You hear the voice prompt “Connected”. The Bluetooth wireless connection is activated.

**i** If you connect the audio cable, the Bluetooth wireless connection is also deactivated (> 35).

**i** If you only want to use the headphones for active noise cancellation ANC during a flight, you can deactivate the touch pad function to avoid unintentional entries (> 34).

## Using the audio cable/activating flight mode

If you connect the audio cable, flight mode is activated and the Bluetooth wireless connection is deactivated.

Use the audio cable when

- wireless transmission is not allowed, e.g. during aircraft take-off and landing,
- the headphone’s rechargeable battery is empty,
- your audio source doesn’t offer a Bluetooth connection.

The functions for controlling music, phone calls or the voice assistant are not available. The active noise cancellation ANC can be fully used provided that the rechargeable battery is charged (> 26).

## Connecting the headphones using the audio cable

- ▷ Connect the 2.5 mm jack plug of the audio cable to the headphones' audio socket.  
Flight mode is activated and the Bluetooth wireless connection is deactivated.
- ▷ Connect the 3.5 mm jack plug to the audio output of your smartphone.

To disconnect the audio cable:

- ▷ Carefully disconnect the jack plug from the headphones.

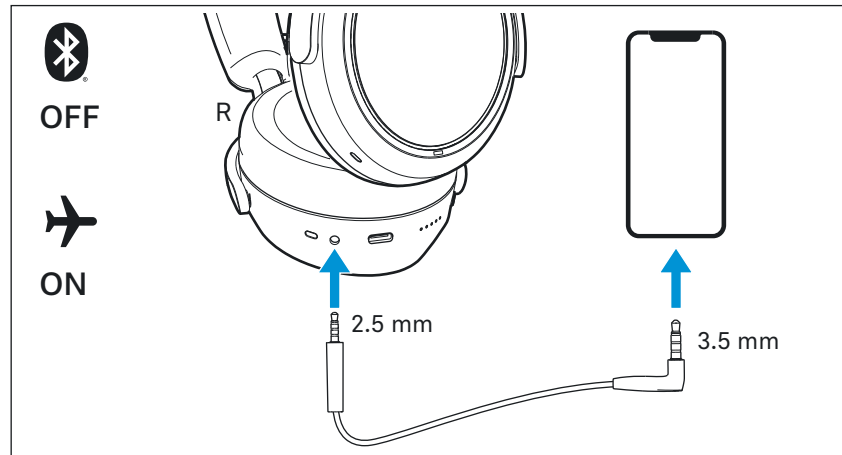

## Using the in-flight adapter

- ▷ Connect the 3.5 mm jack plug of the audio cable (> 36) to the in-flight adapter.
- ▷ Connect the in-flight adapter to the aircraft's in-flight entertainment system.

**i** If the volume of the headphones is too low, first increase the volume on the in-flight entertainment system.

**i** If you want to increase the volume on the headphones and the volume cannot be increased as usual, restart the headphones by switching them off and on again.

## Connecting the headphones using the USB cable

When you connect the headphones to a Mac/PC/mobile device using the supplied USB cable, you can play audio content from your Mac/PC/mobile device directly through the headphones.

**i** The headphones are automatically charged when you connect them to a Mac/PC/mobile device using the USB cable.

### Setting up the headphones as the default audio output and audio input device for your Mac/PC/mobile device

- ▷ Make sure that possible Bluetooth connections are disconnected.
- ▷ Connect the headphones and the Mac/PC or mobile device via the USB cable.  
The headphones are charged via the USB connection.
- ▷ From the Systems Preferences or Control Panel of your Mac/PC/mobile device, select “MOMENTUM 4” as the default audio output device and/or default audio input device.
- ▷ Start music playback from the Mac/PC/mobile device.  
The music is played through the headphones and the microphone is used for recording.

## Storing and transporting the headphones

Store the headphones in the carry case to prevent damage to the headphones when you are not using or transporting them.

**i** If you store or transport the headphones when they are still switched on, the sensor will not detect that the headphones have already been taken off in certain situations, e.g. if you hang them over the edge of a bag or transport them inside a bag.

Information on how to avoid problems with the sensor can be found here: > 33.

- ▷ Fold up the headphones and place them in the carry case as shown in the illustration.  
The headphones automatically switch off.

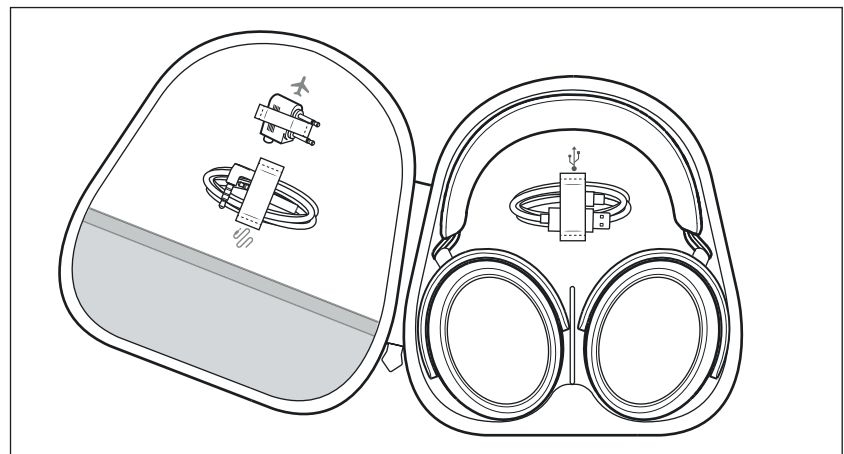

## Care and maintenance

### CAUTION

Liquids can damage the electronics of the product!

Liquids entering the housing of the product can cause a short-circuit and damage the electronics.

- ▷ Keep all liquids far away from the product.
  - ▷ Do not use any solvents or cleansing agents.
- 
- ▷ Clean the parts of the product only with a soft, dry cloth.

To clean the charging socket:

- ▷ Blow vigorously over the charging socket.
- ▷ If necessary, carefully remove any stuck dirt from the charging socket using a dry, soft brush or a dry interdental brush. Only apply gentle pressure when doing so.

## Replacing the ear pads

For reasons of hygiene, you should replace your ear pads from time to time. Spare ear pads are available at

[www.sennheiser-hearing.com/momentum-4-wireless](http://www.sennheiser-hearing.com/momentum-4-wireless) (to purchase online or contact your local Sonova Consumer Hearing partner: [www.sennheiser-hearing.com/service-support](http://www.sennheiser-hearing.com/service-support))

- ▷ Peel the ear pad up and away from the ear cup.
- ▷ Assign the right ear pad to the right ear cup and the left ear pad to the left ear cup.
- ▷ Place the new ear pad onto the ear cup. Make sure that the seam of the ear pad points downwards.
- ▷ Place the ear pad around the ear cup so that the ear pad is fixed in the notch of the ear cup.

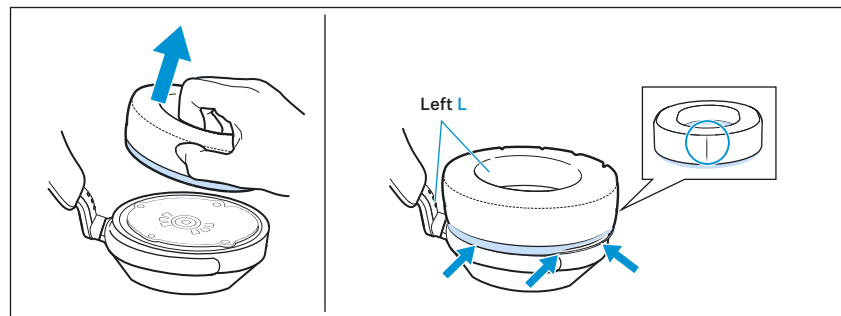

## Information on the built-in rechargeable battery

Sonova Consumer Hearing GmbH ensures and guarantees that the rechargeable batteries perform at their optimum upon purchase of the product. If, upon purchase or within the warranty period, you suspect that a rechargeable battery is obviously defective or if a charging error/battery error is displayed (> 9), stop using the product, disconnect it from the power supply system and contact your Sonova Consumer Hearing partner. Your Sonova Consumer Hearing partner will coordinate the repair/replacement with you.

Do not return a product with a defective battery to your dealer or Sonova Consumer Hearing partner unless requested to do so. To find a partner in your country, search at [www.sennheiser-hearing.com/service-support](http://www.sennheiser-hearing.com/service-support)).

At the end of its operational lifetime, this product with its built-in rechargeable battery must be disposed of separately from normal household waste. You can find more information here: > 43.

## Installing firmware updates

Firmware updates can be downloaded free of charge from the Internet using the Sennheiser Smart Control app. Sonova Consumer Hearing recommends to always install the latest firmware version to ensure the best performance of your product.

- ▷ Connect the headphones to your smartphone and start the Smart Control app (> 19).
- ▷ The app provides information on available firmware updates and guides you through the installation process.

## FAQ/If a problem occurs ...

If a problem has occurred, proceed in the following order until the problem is solved and you can use the headphones again:

1. Press the multi-function button for 15 seconds (reset). (> 41).
2. Connect the headphones to the Smart Control app to install the latest firmware (> 39).
3. Reset the headphones to the factory default settings (> 41).
4. Check the list of frequently asked questions to see if there is a solution to the problem (> 40).
5. Contact your Sonova Consumer Hearing partner to solve the problem (> 40).



### Current list of frequently asked questions (FAQ)

Visit the MOMENTUM 4 product page at [www.sennheiser-hearing.com/download](http://www.sennheiser-hearing.com/download).

There you will find a current list of frequently asked questions (FAQ) and suggested solutions.

### Your question has not been answered or the problem persists?

If a problem occurs that is not listed in the FAQ section or if the problem cannot be solved with the proposed solutions, please contact your Sonova Consumer Hearing partner for assistance.

To find a partner in your country, search at [www.sennheiser-hearing.com/service-support](http://www.sennheiser-hearing.com/service-support).

### Leaving the Bluetooth transmission range

Wireless calling and streaming are only possible in the Bluetooth transmission range of your smartphone. The transmission range largely depends on environmental conditions such as wall thickness, wall composition etc. With a free line of sight, the transmission range of most smartphones and Bluetooth devices is up to 10 meters. If you, and therefore the headphones, leave the Bluetooth transmission range of the smartphone, the sound quality deteriorates increasingly until you hear the voice prompt “Lost connection” and the connection breaks down completely. If you immediately re-enter the Bluetooth transmission range, the connection is automatically re-established.

### Resetting the headphones

If the function of the headphones is disturbed, perform a reset. Individual settings such as the pairing settings are not deleted.

- ▷ Press the multi-function button for 20 seconds.  
You hear a short confirmation sound.

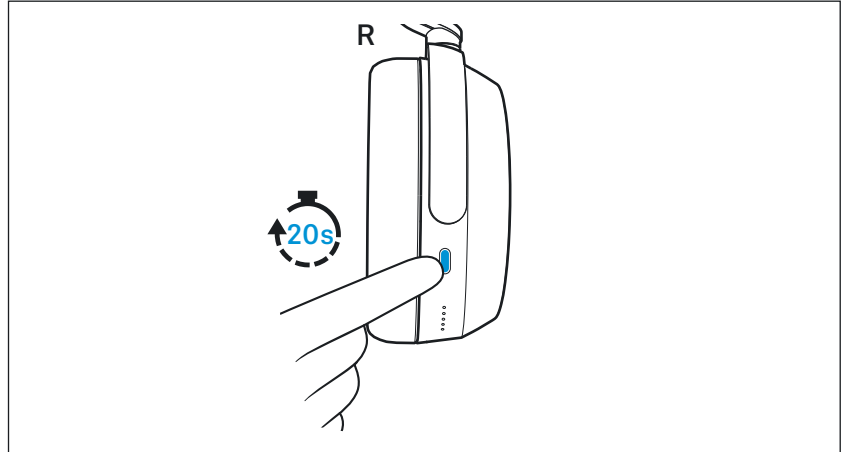

### Deleting the Bluetooth pairing list of the headphones

You can delete the Bluetooth pairing list using the Smart Control app. Follow the instructions in the app.

### Resetting the headphones to the factory default settings

To be able to reset the headphones to the factory default settings, you require the Smart Control app (> 19).

- ▷ Switch on the headphones (> 19) and connect them to a Bluetooth device on which the Smart Control app is available.
- ▷ Select the “Factory default settings” function in the app settings.
- ▷ Follow the instructions in the app.

# Specifications

## Model: M4AEBT

Wearing style	Bluetooth® around-ear, closed-back
Ear coupling	circum-aural
Transducer principle	dynamic
Transducer	42 mm
Frequency response	6 Hz to 22,000 Hz (-10 dB)
Sound pressure level (SPL)	106 dB (1 kHz/0 dBFS)
THD (1 kHz, 100 dB SPL)	< 0.3 % (1 kHz, 100 dB SPL)
Microphone principle	MEMS
Microphone frequency response	80 Hz to 8,000 Hz (-3 dB)
Microphone pick-up pattern (speech audio)	4 omni-directional microphones 2x2-mic beamforming array
Power supply	built-in rechargeable lithium-polymer battery: 3.7 V $\approx$ , 700 mAh, 2.7 Wh USB charging: 5 V $\approx$ , 750 mA max.
Charging time of rechargeable battery	approx. 2 hrs
Operating time	up to 60 hrs (music playback via Bluetooth with ANC activated)
Temperature range	<i>operation:</i> 0 °C to +40 °C <i>charging:</i> +10 °C to +40 °C <i>storage:</i> -20 °C to +60 °C
Relative humidity (non condensing)	<i>operation:</i> 10 to 80 % <i>storage:</i> 10 to 90 %
Weight (headphones)	approx. 293 g
Magnetic field strength	6.25 mT

## Bluetooth

Version	Bluetooth 5.2 compliant, class 1
Transmission frequency	2,402 MHz to 2,480 MHz
Modulation	GFSK, $\pi/4$ DQPSK, 8DPSK
Profiles	HFP, AVRCP, A2DP
Output power	10 mW (max)
Codec	aptX™ Adaptive, AAC, SBC
Device name	MOMENTUM 4 (individually adjustable) LE-MOMENTUM 4 (Bluetooth Low Energy only)
Number of active connections	2

# Manufacturer Declarations

## Warranty

Sonova Consumer Hearing GmbH gives a warranty of 24 months on this product.

For the current warranty conditions, please visit our website at [www.sennheiser-hearing.com/warranty](http://www.sennheiser-hearing.com/warranty) or contact your Sonova Consumer Hearing partner.

## In compliance with the following requirements

- General Product Safety Directive (2001/95/EC)
- Compliant to **Sound Pressure Limits** according to country specific requirements

## EU declaration of conformity



- RoHS Directive (2011/65/EU)

Hereby, Sonova Consumer Hearing GmbH declares that the radio equipment type M4AEBT is in compliance with the Radio Equipment Directive (2014/53/EU).

The full text of the EU declaration of conformity is available at the following Internet address:

[www.sennheiser-hearing.com/download](http://www.sennheiser-hearing.com/download).

## UK declaration of conformity



- RoHS Directive (2012)
- Radio Equipment Regulations (2017)

## Notes on disposal



- EU: Battery Directive (2006/66/EC & 2013/56/EU)
- EU: WEEE Directive (2012/19/EU)
- UK: Battery Regulations (2015)
- UK: WEEE Regulations (2013)

The symbol of the crossed-out wheeled bin on the product, the battery/rechargeable battery (if applicable) and/or the packaging indicates that these products must not be disposed of with normal household waste, but must be disposed of separately at the end of their operational lifetime. For packaging disposal, observe the legal regulations on waste segregation applicable in your country. Improper disposal of packaging materials can harm your health and the environment.

The separate collection of waste electrical and electronic equipment, batteries/rechargeable batteries (if applicable) and packagings is used to promote the reuse and recycling and to prevent negative effects on your health and the environment, e.g. caused by potentially hazardous substances contained in these products. Recycle electrical and electronic equipment and batteries/rechargeable batteries at the end of their operational lifetime in order to make contained recyclable materials usable and to avoid littering the environment.

If batteries/rechargeable batteries can be removed without damaging them, you are obliged to dispose of them separately (for the safe removal of batteries/rechargeable batteries, see the instruction manual of the product). Handle lithium-containing batteries/rechargeable batteries with special care, as they pose particular risks, such as the risk of fire and/or the risk of ingestion in the case of coin batteries. Reduce the generation of battery waste as much as possible by using longer-life batteries or rechargeable batteries.

Further information on the recycling of these products can be obtained from your municipal administration, from the municipal collection points, or from your Sonova Consumer Hearing partner. You can also return electrical or electronic equipment to distributors who have a take-back obligation. Herewith you make an important contribution to the protection of the environment and public health.

### Trademarks

Apple, the Apple logo and Siri are trademarks of Apple Inc., registered in the U.S. and other countries. App Store is a service mark of Apple Inc.

Android and Google Play are registered trademarks of Google Inc.

The Bluetooth® word mark and logos are registered trademarks owned by Bluetooth SIG, Inc. and any use of such marks by Sonova Consumer Hearing GmbH is under license.

Qualcomm aptX™ is a product of Qualcomm Technologies International, Ltd. Qualcomm is a trademark of Qualcomm Incorporated, registered in the United States and other countries, used with permission.

aptX™ is a trademark of Qualcomm Technologies International, Ltd., registered in the United States and other countries, used with permission.

Other product and company names mentioned in the user documentation may be the trademarks or registered trademarks of their respective holders.