

TP-LINK TAPO H500 USER MANUAL



Quick Links

[Check/Manage Connected Devices](#)

[Storage Settings](#)

[Camera Playback](#)

[Screen Mirror](#)

Table of Contents

[Table of Contents](#)

[About This Guide](#)

[Introduction](#)

[Install Hard Drive](#)

[Set Up Your HomeBase](#)

[Use Your HomeBase](#)

[Check/Manage Connected Devices](#)

[Facial Recognition](#)

[Storage Settings](#)

[AI Empowerment](#)

[Camera Playback](#)

[Screen Mirror](#)

[USB Access](#)

[Manage Device Settings](#)

[Reset Your HomeBase](#)

[Authentication](#)

[Other ManualsLib Projects](#)



User Guide

Smart HomeBase

Contents

About This Guide	1
Introduction	2
Install Hard Drive	6
Set Up Your HomeBase	8
Use Your HomeBase	9
Check/Manage Connected Devices	10
Storage Settings	17
AI Empowerment	18
Camera Playback	19
Screen Mirror	20
USB Access	22
Manage Device Settings	23
Reset Your HomeBase	28
Authentication	31

About This Guide

This guide provides a brief introduction to the Smart HomeBase and the Tapo app, as well as regulatory information.

Please note that features available in Tapo may vary by model and software version. Tapo availability may also vary by region. All images, steps, and descriptions in this guide are only examples and may not reflect your actual Tapo Camera experience.

Conventions

In this guide, the following convention is used:

Convention	Description
Blue	Key information appears in blue, including management page text such as menus, items, buttons and so on.
<u>Underline</u>	Hyperlinks are in blue and underlined. You can click to redirect to a website.
■ Note:	Ignoring this type of note might result in a malfunction or damage to the device.

More Info

- Specifications can be found on the product page at <https://www.tapo.com>.
- Our Technical Support and troubleshooting information can be found at <https://www.tapo.com/support/>.
- Setup video can be found at <https://www.tp-link.com/support/setup-video/#smart-hub>.

Introduction

Smart living starts here with up to 64 smart sensors + 16 cameras or video doorbells connected to your smart home ecosystem.

- **Local Storage** – With 16GB of built-in storage, expandable up to 16TB via an additional hard drive, you can store massive video clips locally. Save money by avoiding extra SD cards and monthly fees for your security cameras.
- **4-Channel Live View** – Watch live views and playback on your phone or pad, or monitor up to 4 channels in real-time on a large screen via the HDMI port.
- **Enhanced Smart AI Detection** – Provides multiple free enhanced AI functions such as facial recognition, person & pet & vehicle detection, and more. Effectively filters invalid alerts from non-human and non-vehicle sources.
- **Multi-layer Encryption** – Use multi-layer encryption technology like AES 128-bit and TLS 1.2 encryption protocols, and store videos locally to keep your privacy safe.
- **Home Security at Ease** – Real-time viewing, event playback, and daily summary viewing of all connected cameras on an app page. Quickly find the events you want by tag.
- **Facial Recognition** – Identifies strangers, family, and friends, categorizing them to trigger alarms selectively, enhancing accuracy and minimizing false alarms.
- **AI Empowerment** – Empower your compatible cameras and doorbells with enhanced AI capability like facial recognition, providing a higher level of security and elevated user experience.
- **Offline Recording** – Enjoy secure offline storage for all recordings, ensuring your data remains intact even during network interruptions.
- **USB Sharing** – Share recorded videos with other devices on your network.



Appearance

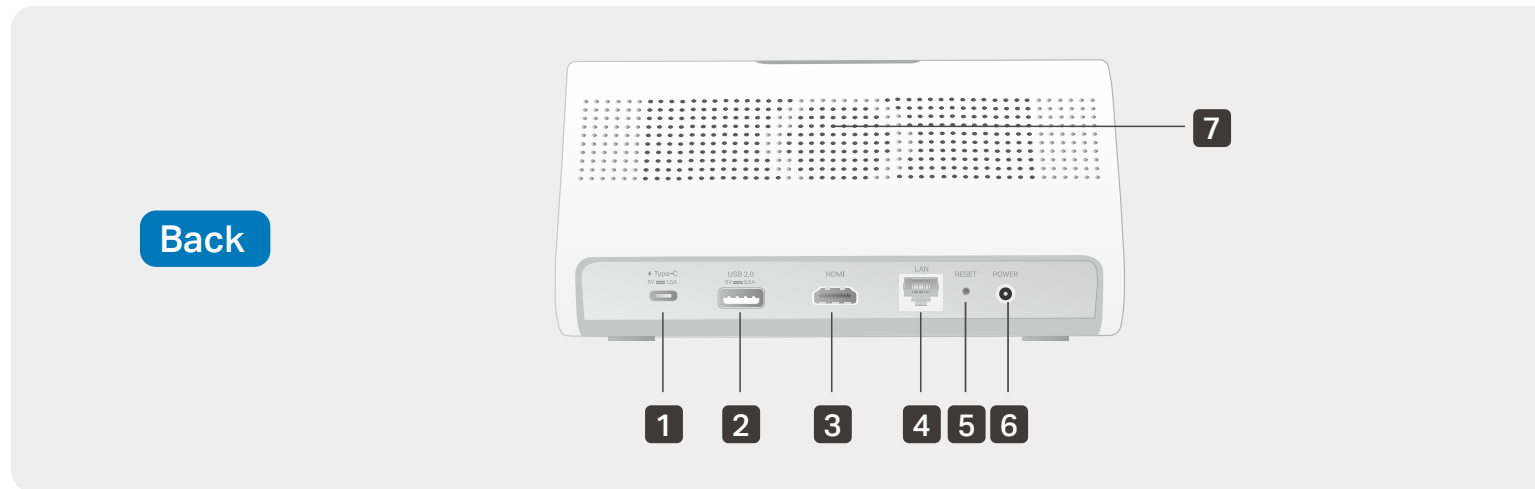

1 Type-C Port

5V/1.5A type-C port for charging your devices (e.g., battery-powered cameras). This port cannot transfer any data.

2 USB 2.0 Port

5V/0.5A USB port for exporting data to another device.

3 HDMI Port

Output port for high-definition audio and video signals. You can connect it to a TV or monitor to project camera videos.

4 LAN Port

Connect to a router or a switch using an Ethernet cable.

5 RESET

Press and hold for 10 seconds to restore factory default settings.

6 12V/2A Power Port

7 Speaker

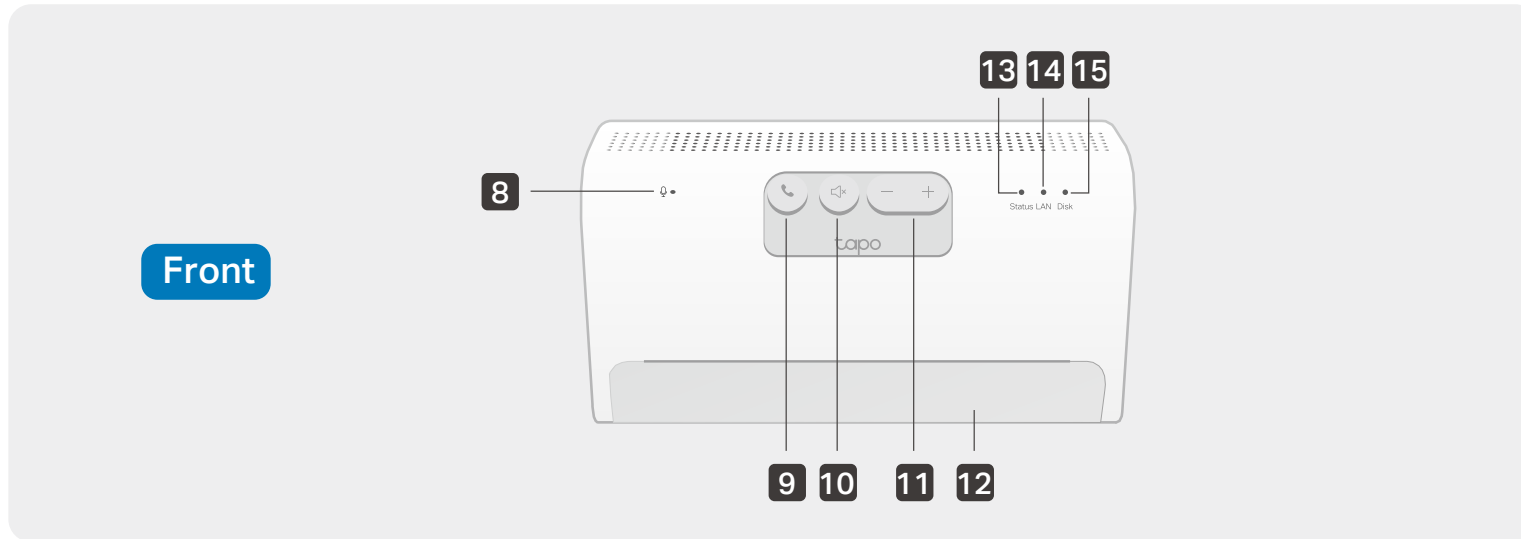

8 Microphone

9 Answer/SYNC Button

Press once: Answer the video call.
Press and hold for 3 seconds: Enter pairing mode.

10 Decline/Mute Button

Decline the video call, or silence the alarm.

11 Volume Button

Volume up or down.

9 + 11

Switch to the **previous** or **next** channel when using HDMI output.

12 Pad Holder

Easily place your pad here.

13 Status LED

14 LAN LED

15 Disk LED

Status LED Indications

Solid red	Starting up
Blinking red slowly	Ready for setup
Blinking red and green	Connecting to Wi-Fi
Blinking green slowly	Connected to Wi-Fi (Wireless) Connected to router (Ethernet)
Solid green	Connected to the cloud
Blinking amber slowly	Disconnected from router
Blinking red quickly	HomeBase resetting
Blinking green quickly	HomeBase updating Pairing
Off	HomeBase powered off

LAN LED Indications

On	Ethernet network working properly
Off	Ethernet cable not connected

Disk LED Indications

Solid green	Hard drive working properly
Solid red	Hard drive malfunction
Off	No hard drive connected

Install Hard Drive

Install an extra HDD/SSD drive (2.5") to expand local storage.

Note:

1. Back up all the data on your hard drive before installation as Tapo may need to format your hard drive.
2. The HomeBase must be powered off when you install or remove a hard drive.

1. Push down the cover to remove it. The  sign shows the place where you should press.

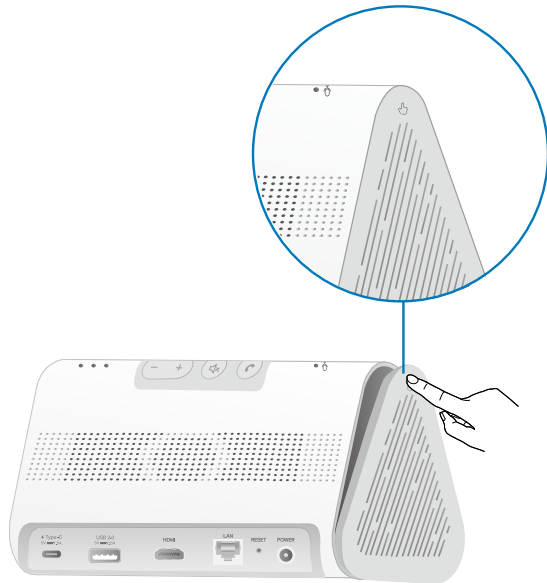

2. Loosen the screw and pull out the hard drive bracket.

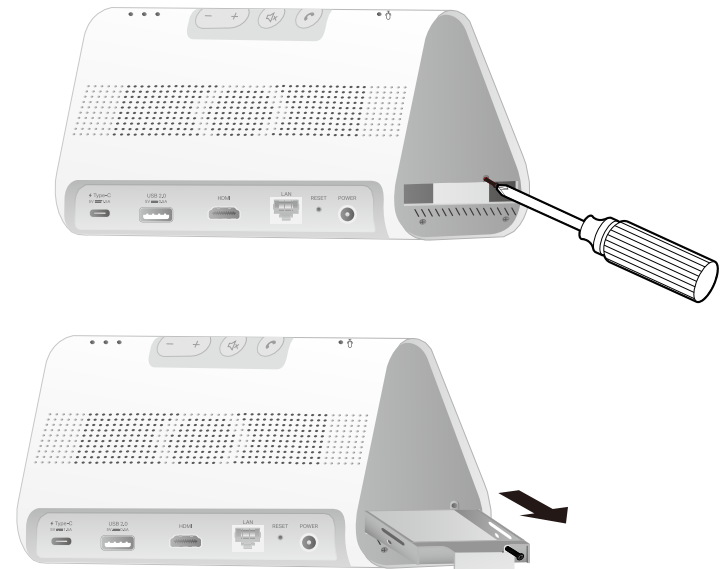

3. Put in your hard drive and secure it with the provided screws.

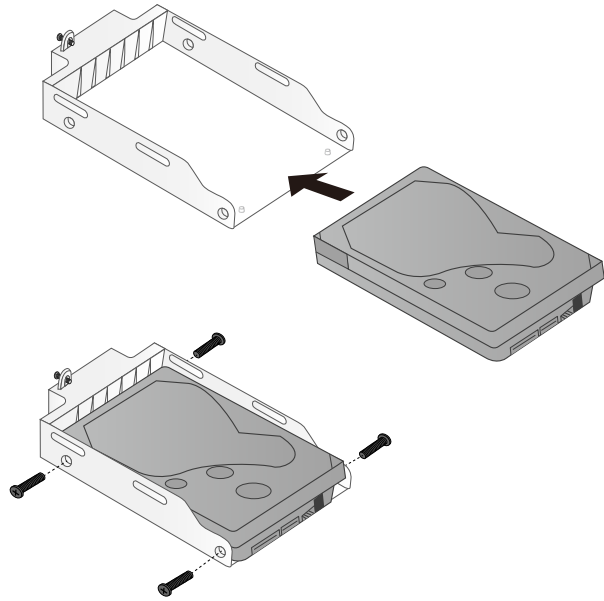

4. Insert the bracket back into the HomeBase. Secure it with the screw. Then replace the cover.

Note: Initialize the hard drive in the Tapo app.

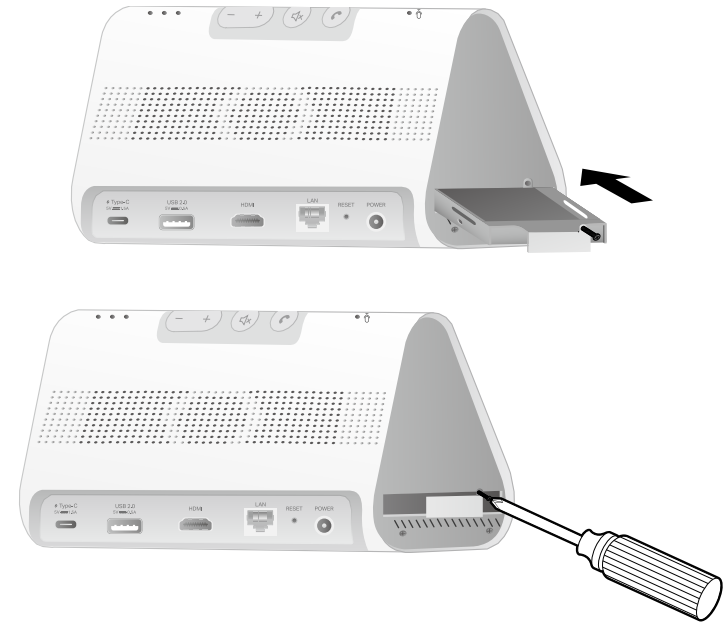

Set Up Your HomeBase

Follow the steps below to set up your HomeBase.

Step 1. Download Tapo App

Get the [Tapo](#) app from the App Store or Google Play, or by scanning the QR code below.



Step 2. Log In

Open the app, and log in with your TP-Link ID. If you don't have an account, create one first.

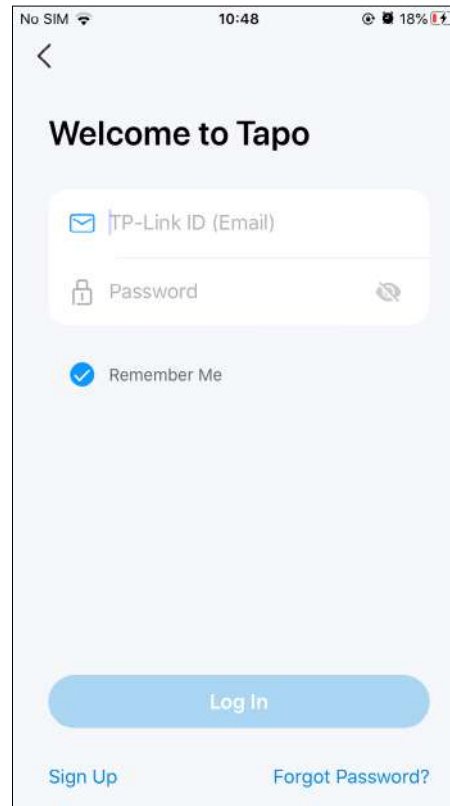

Step 3. Add Your HomeBase

Tap the ⊕ button in the app, select [Hubs/HomeBase](#) and then your model. Follow the app instructions to set up your HomeBase and add accessories to it.

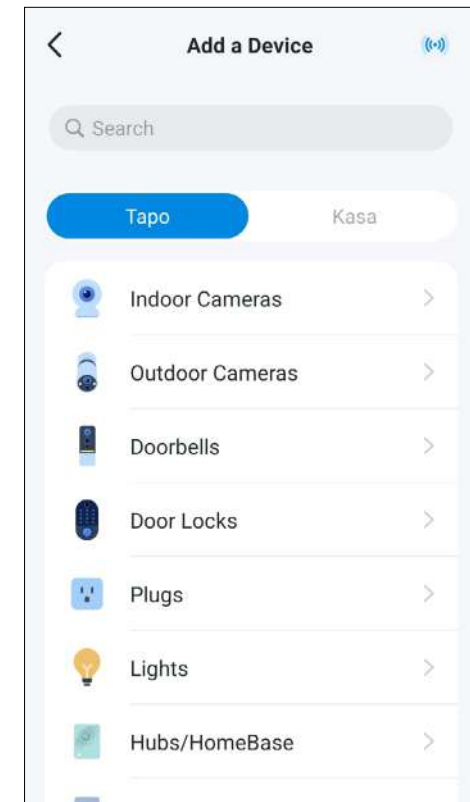

Use Your HomeBase

After setup, your device will be listed on the Home page. You can tap your device to manage it.

1. Home Page

You can check your battery, favorite/unfavorite, and remove your device on the Home page.

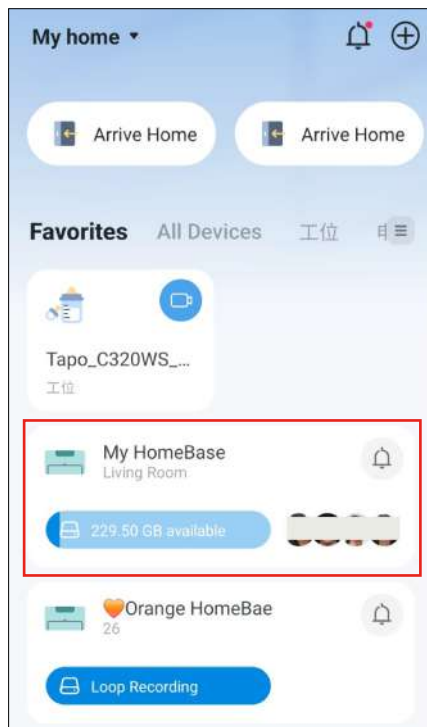

2. Status Page

Check/manage connected devices, check facial recognition report, have access to the storage, AI Empowerment, USB access, screen mirror, camera playback, and ring log. You can also play the ringtone on this page.

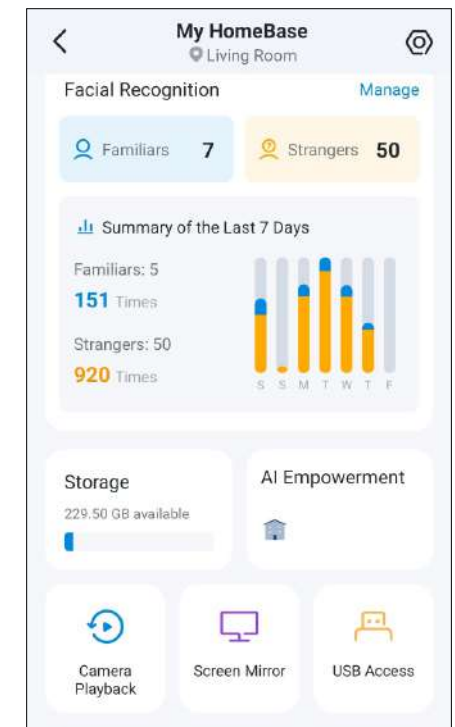
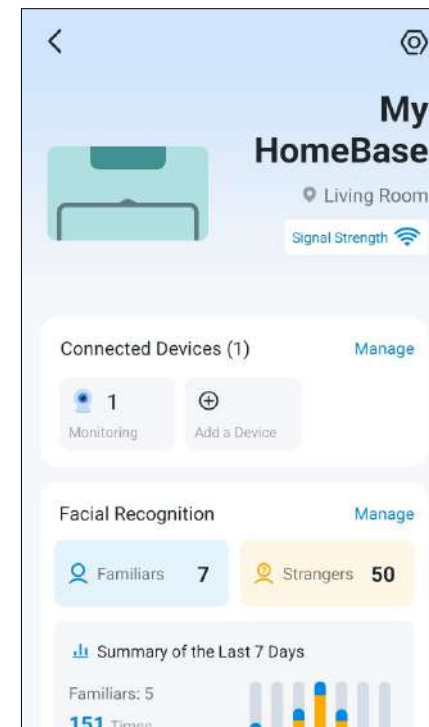

Check/Manage Connected Devices

Check/manage what devices are connected to your HomeBase.

1. Check Connected Devices

Tap the [Connected Devices](#) card. The connected devices are categorized into two types: paired devices and accessible devices.

Paired Devices: Sub-G devices like sensors and cameras/doorbells that need to be bridged through the HomeBase to connect to the Wi-Fi network.

Accessible Devices: Cameras/doorbells that only utilize the storage or the hotspot of your HomeBase. They can be AI empowered by the HomeBase to enhance their AI capabilities.

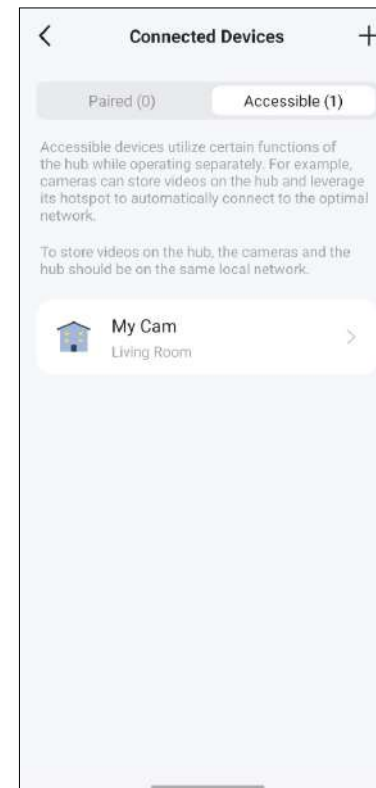
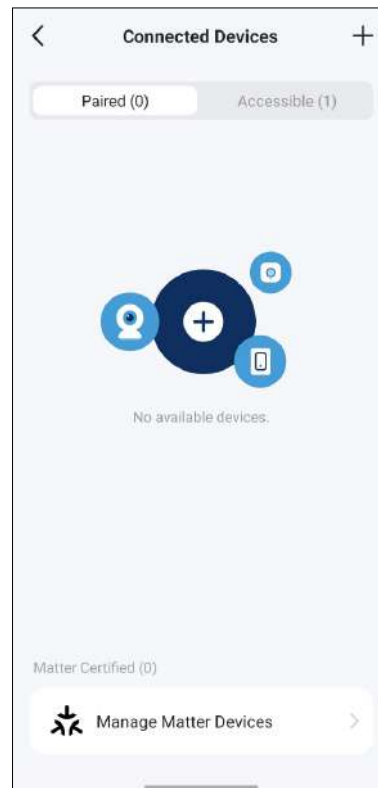
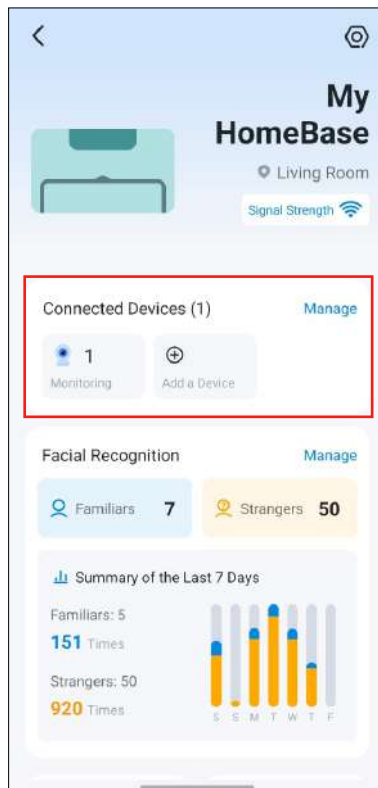

2. Add Connected Devices

Tap the + icon. Choose what devices you want to add to the HomeBase.

[Set Up a New Device](#): Set up a new Tapo or third-party Matter device.

[Connect Existing Devices](#): Bind your existing camera/doorbell to the HomeBase for the HomeBase storage and AI Empowerment.

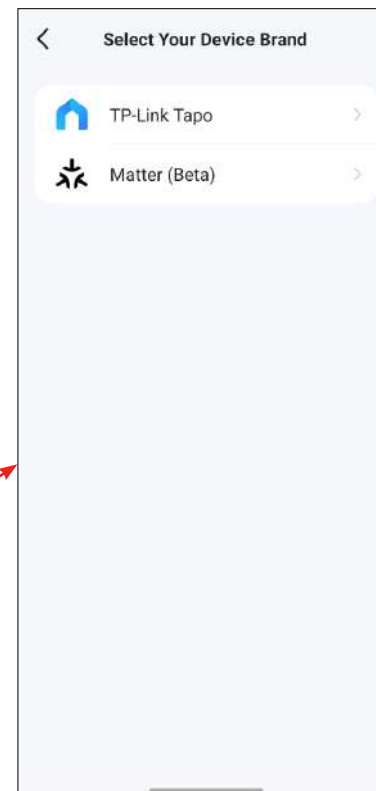
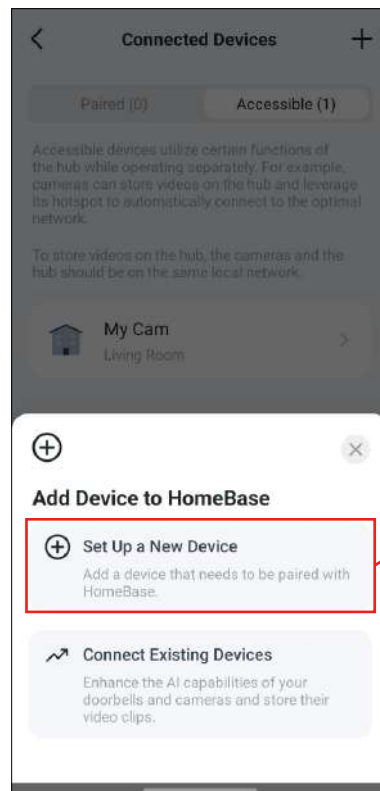
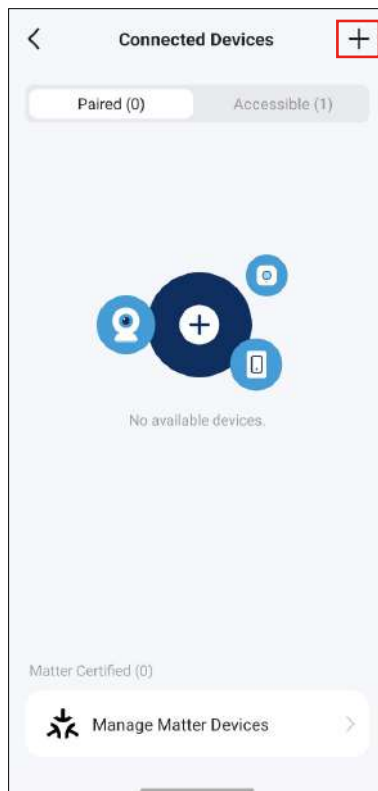

3. Manage Matter Devices

Tap [Manage Matter Devices](#) at the bottom. You can manage your third-party Matter devices that have been added to Tapo.

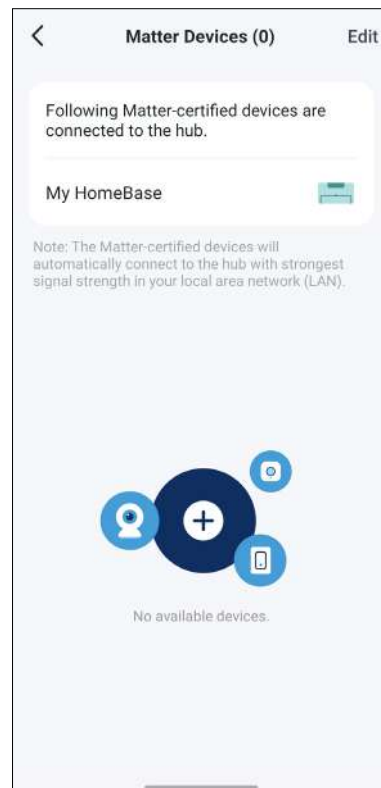
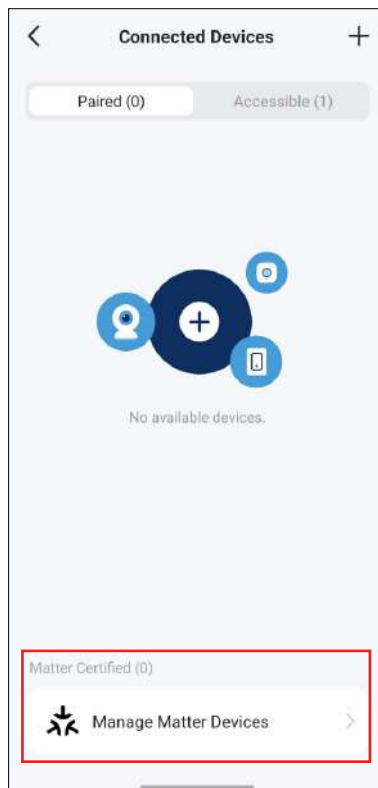

Facial Recognition

The HomeBase can recognize faces captured by the connected cameras and track their activities.

1. Manage Familiars and Strangers

Tap the [Facial Recognition](#) card. You can add or delete familiars, delete strangers in batch, and check their activities.

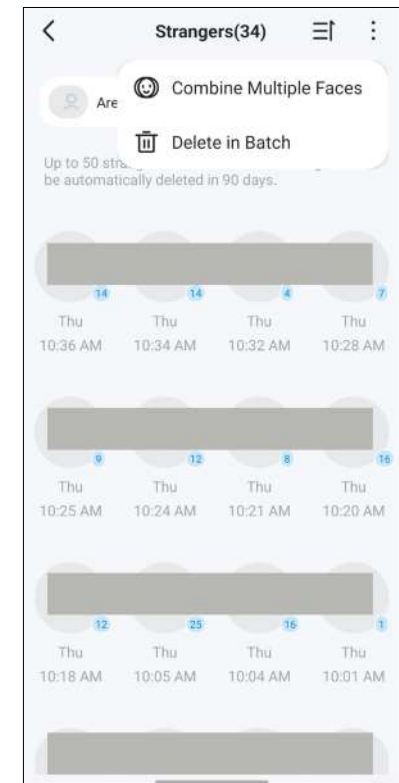
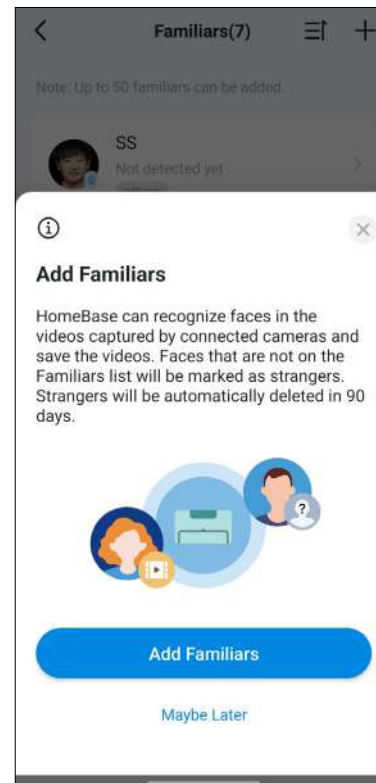
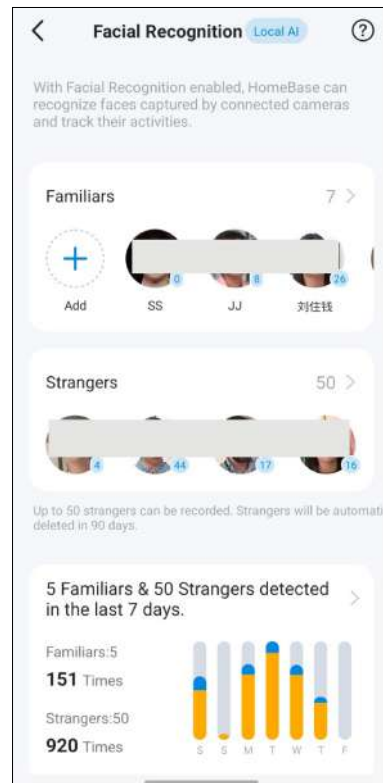
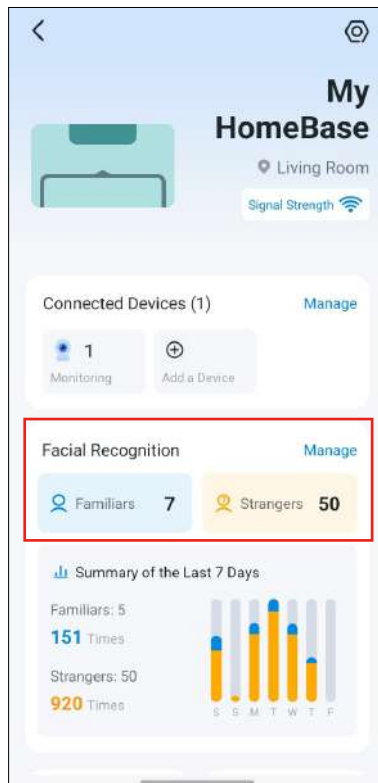

2. Check Facial Recognition Report

You can check the daily/weekly/monthly activities detected of the familiars and strangers. You can set whether to receive the facial recognition report notifications and the notifications frequency.

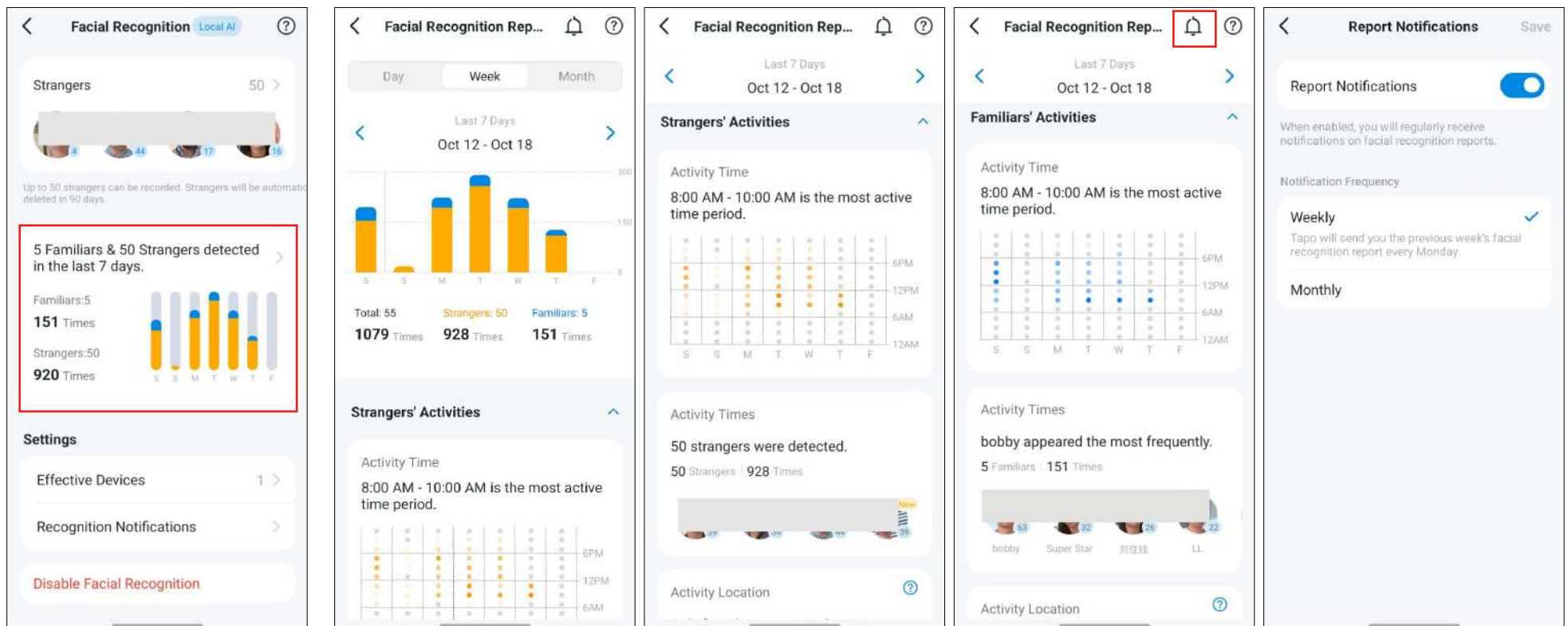

3. Check Devices with Facial Recognition Enabled

Tap [Effective Devices](#) and then you can see the cameras/doorbells with Facial Recognition enabled. These devices are AI empowered to support Facial Recognition.

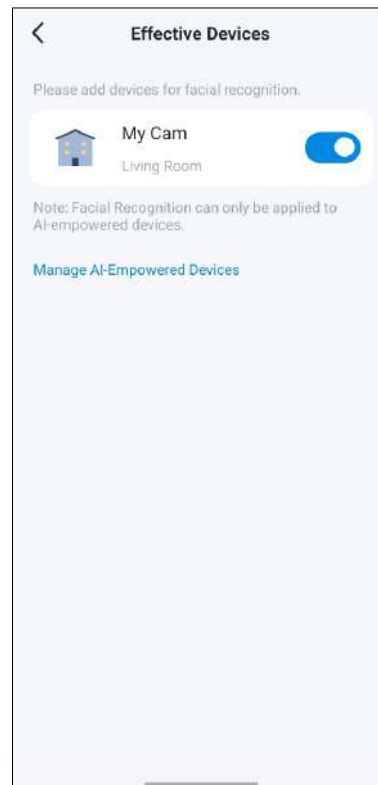

4. Facial Recognition Notifications Settings

Tap [Recognition Notifications](#) and then you can see the cameras/doorbells with Facial Recognition enabled. There devices are AI empowered to support Facial Recognition.

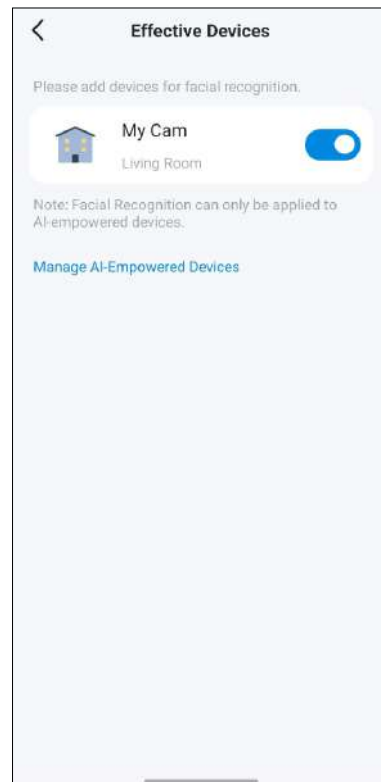

Storage Settings

The connected cameras/doorbells can leverage the HomeBase's storage to store recorded videos.

Manage HomeBase Storage

Tap the [Storage](#) card. Check how much storage space is used, information of the hard drive, and what devices are using HomeBase's storage. You can also enable [Loop Recording](#) to let new recordings overwrite previous recordings.

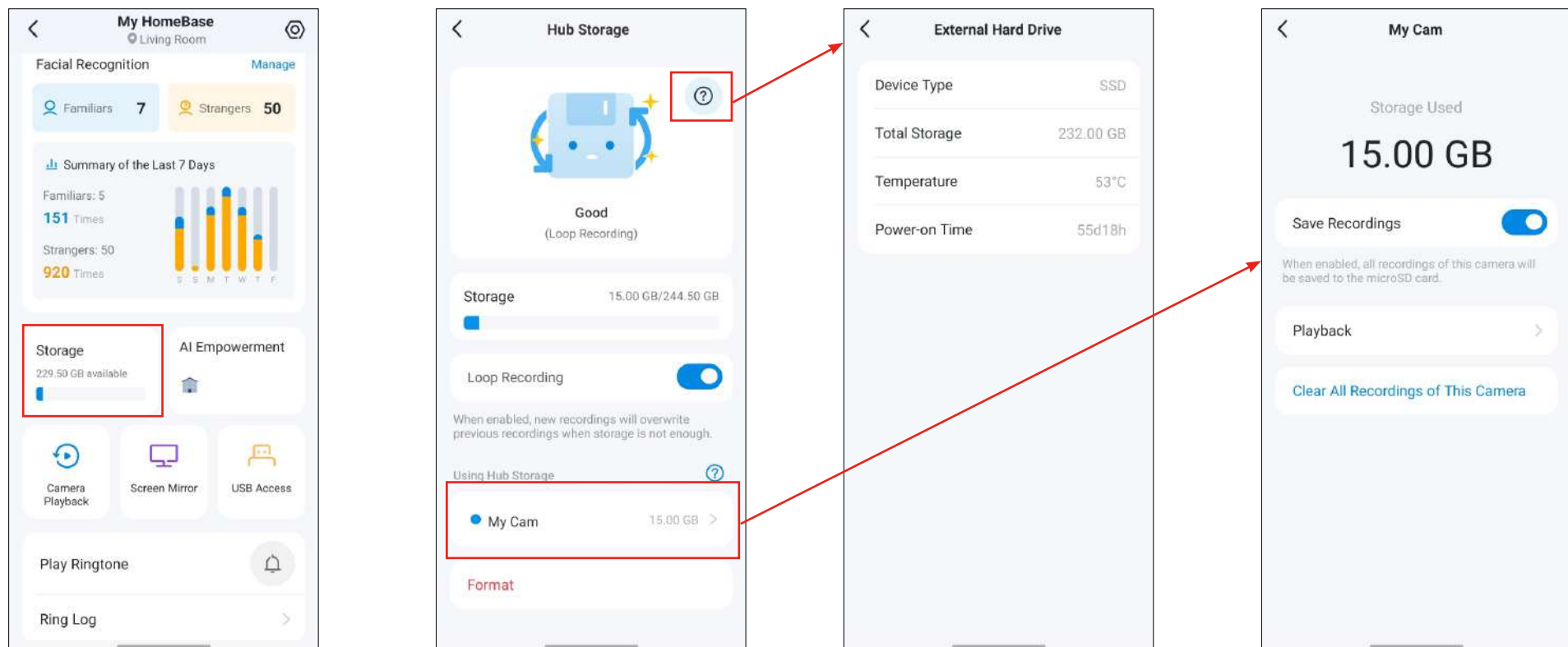

AI Empowerment

Enhance the AI capabilities of the connected cameras/doorbells with AI Empowerment.

Enhance Your Cameras/Doorbells

Tap [Add Devices](#) and select the cameras/doorbells to be enhanced.

Tap your AI-empowered devices to select the empowered detection types.

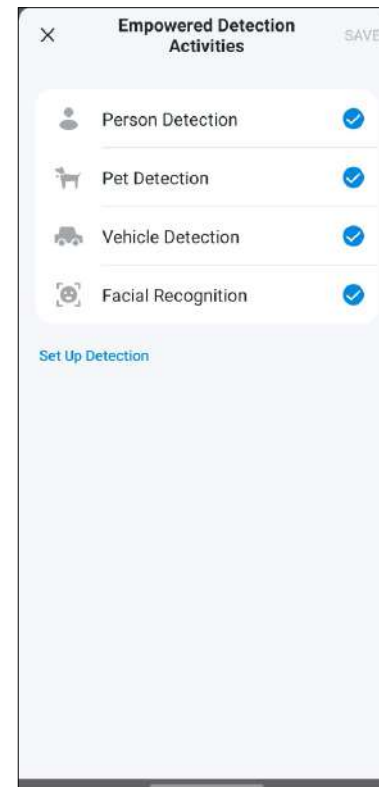
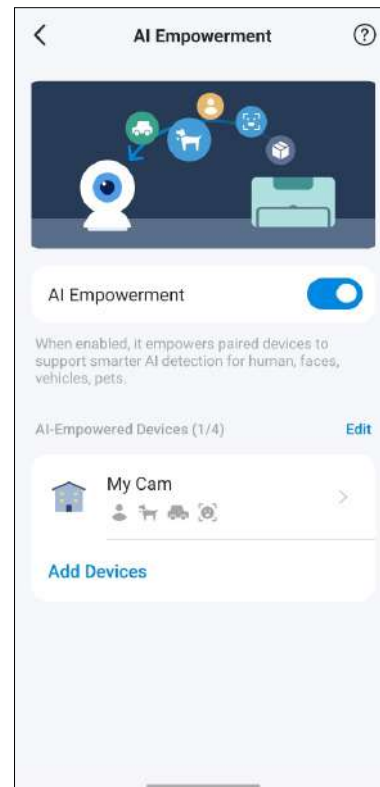
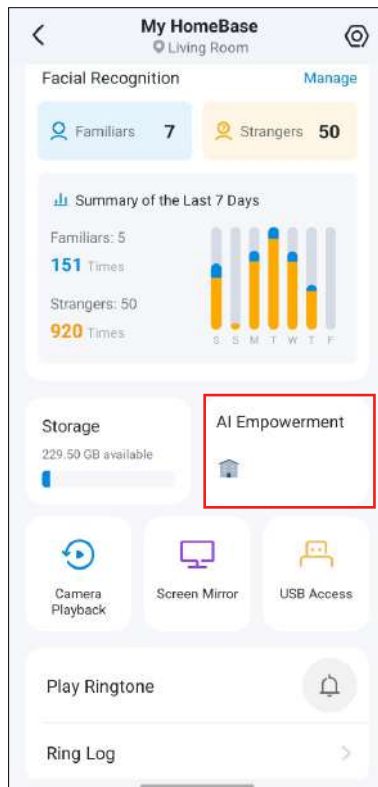

Camera Playback

Play back videos recorded by the connected cameras.

Check Camera Playback

Select your cameras and play back the recordings.

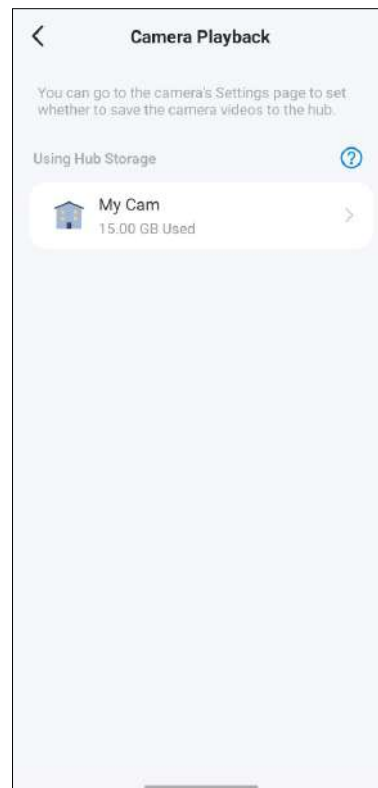
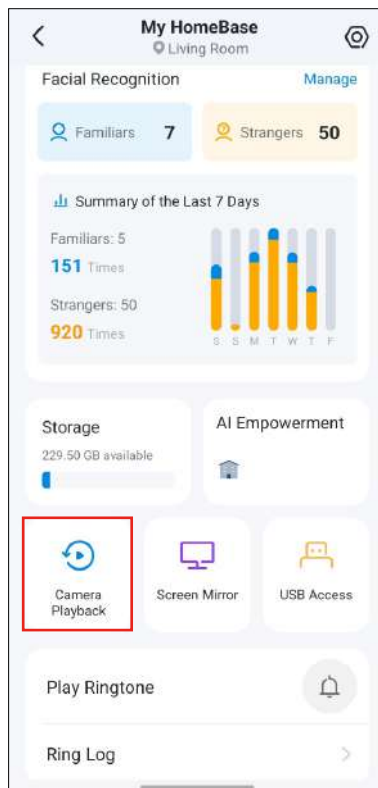

Screen Mirror

Cast your cameras to a TV or monitor and create dashboards to for easier management.

Explore Screen Mirroring Capabilities

Cast your cameras to a TV or monitor for streamlined management via dashboards.

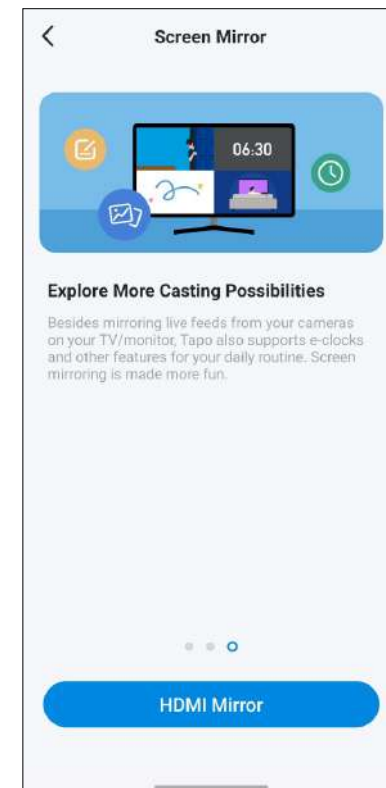
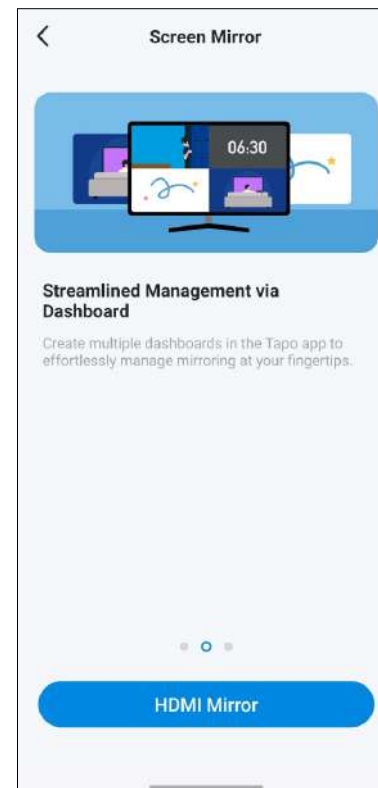
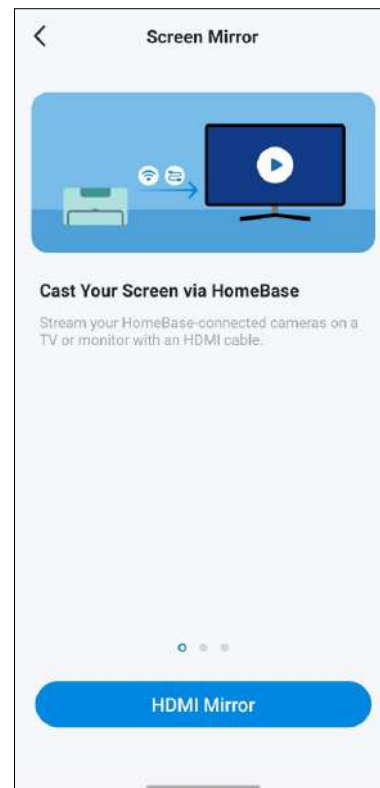
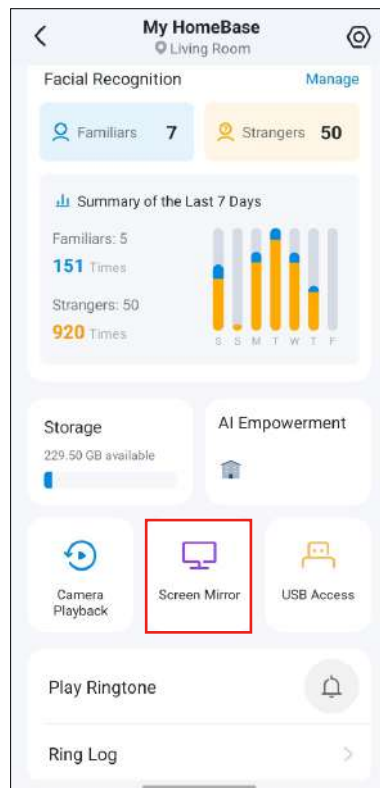

Start HDMI Screen Mirroring

Use an HDMI cable to connect your HomeBase to your streaming device like a TV or monitor. Make sure you have selected the HDMI input on your streaming device. Then tap HDMI Mirror and follow app instructions to start mirroring your cameras.

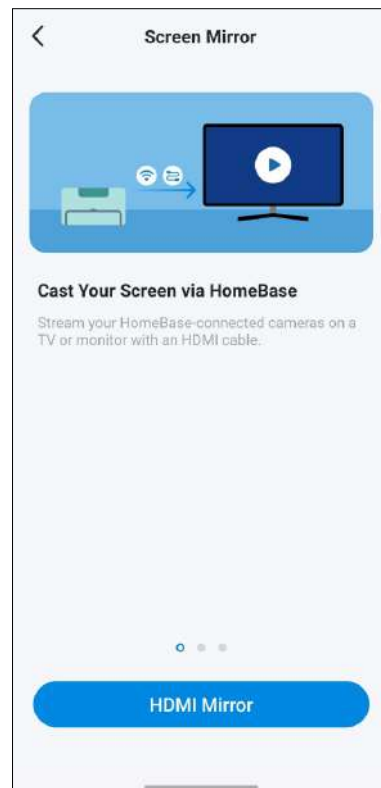
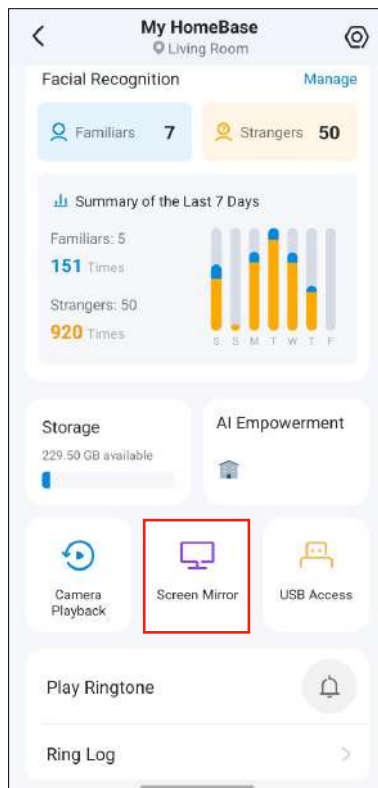

USB Access

Connect a USB device to back up or share the recorded videos.

Back Up & Share Videos

Tap [Start a New Backup](#). Select your camera to be backed up, what types of videos within what time range will be backed up.

Tap [Share Now](#) to share videos of a USB device to others on the internet.

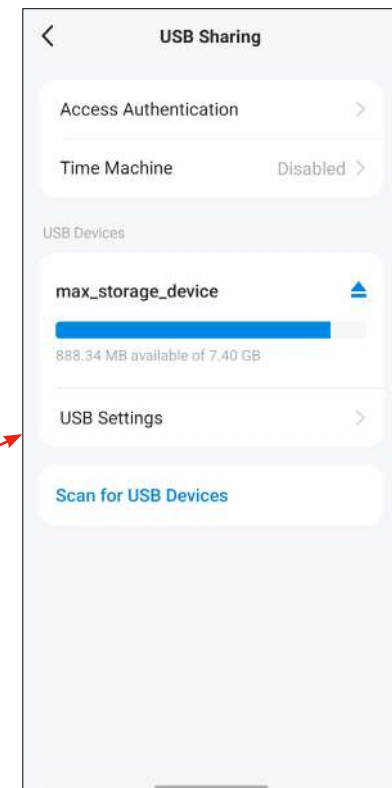
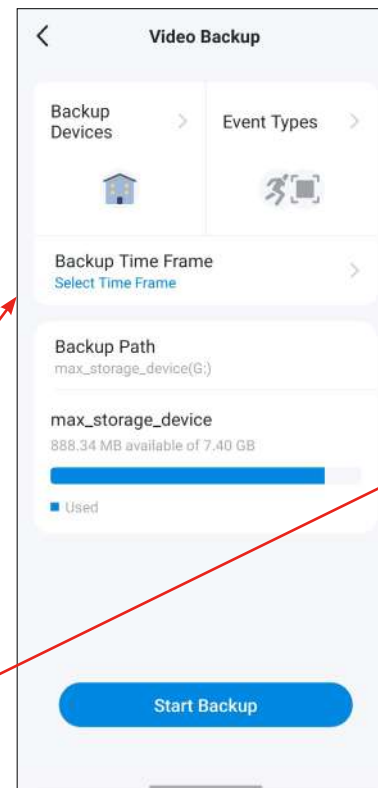
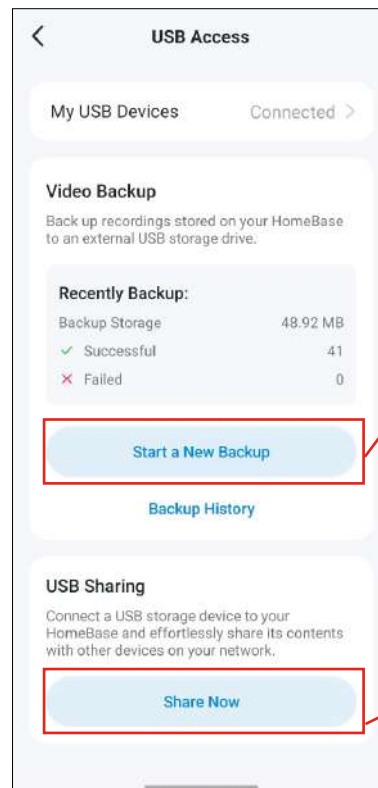
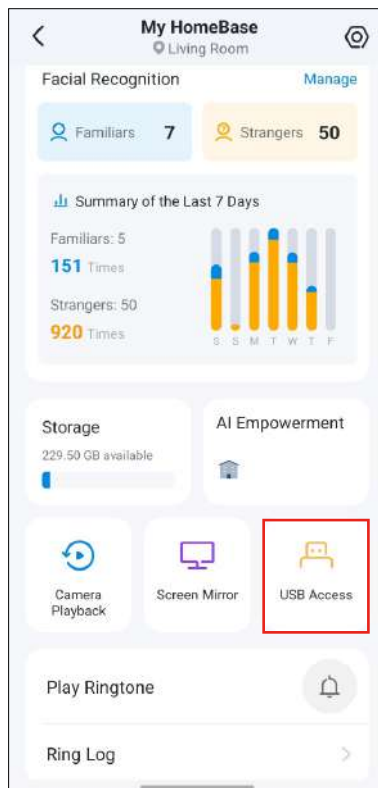

Manage Device Settings

Go to the Device Settings page and configure the settings as you need.

1. Set Ringtones

Set the ringtone and its playing duration.

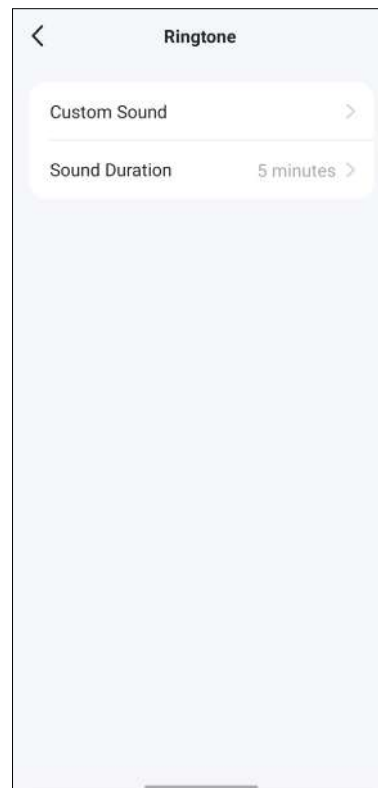
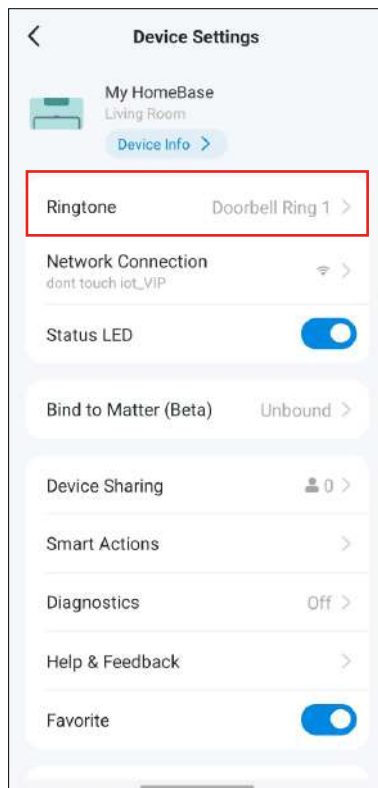

2. Check Network Connection

Check whether your HomeBase is connected to a Wi-Fi network or to your router via an Ethernet cable. You can also test Wi-Fi signal and switch to another Wi-Fi network.

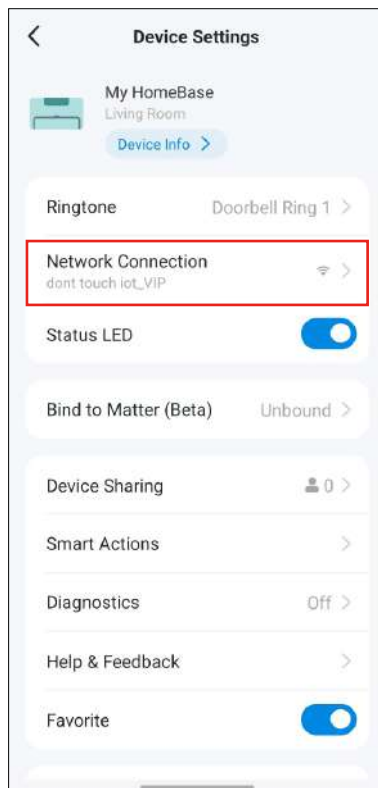

3. Bind to Matter

Add your HomeBase and its connected devices to other Matter-compatible ecosystems via a setup code. Please complete pairing before the countdown ends. If timed out, revisit this page and then try again.

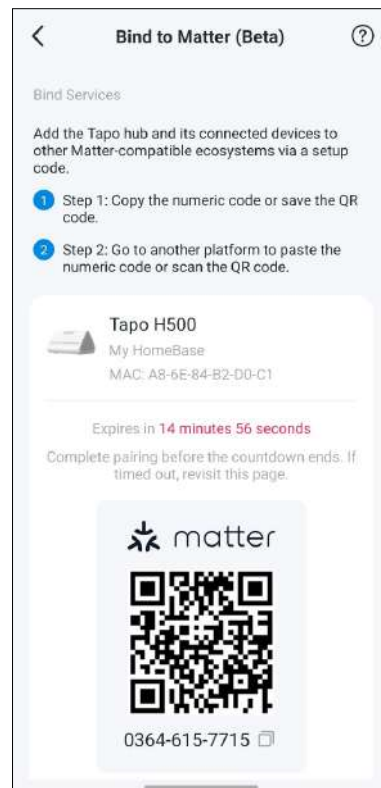
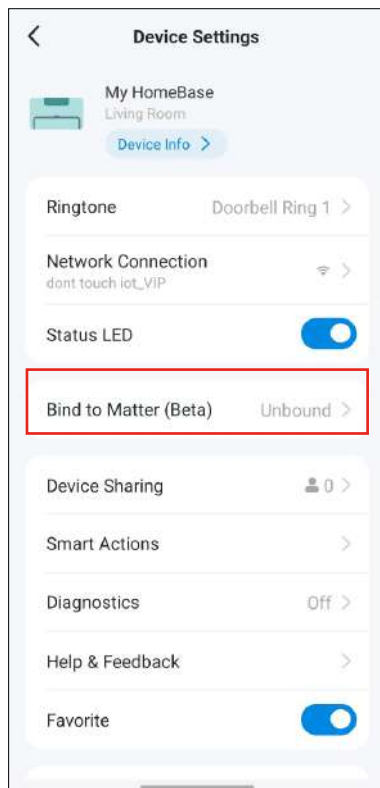

4. Smart Actions

Tapo provides recommended Automation templates for your HomeBase to simplify your daily routine. You can also check the already configured smart actions that your HomeBase is involved in.

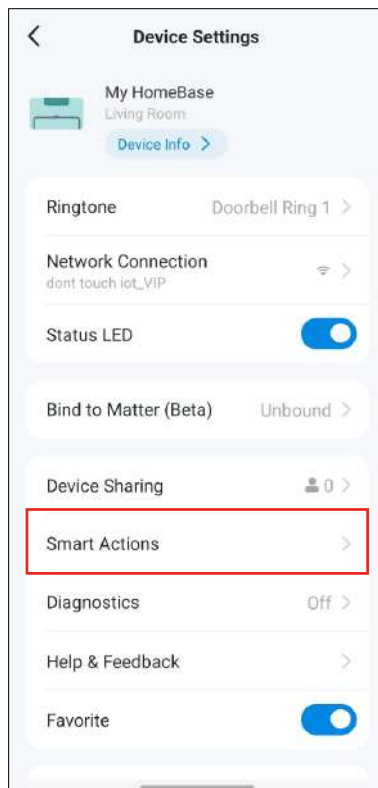

5. Auto Reboot

When enabled, your HomeBase will reboot automatically at your specified time.

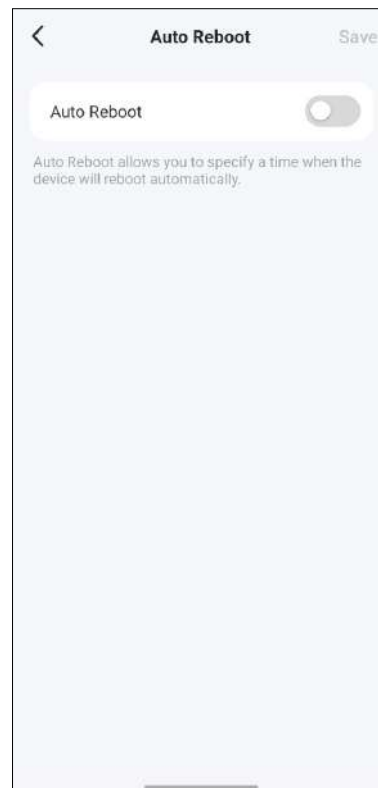
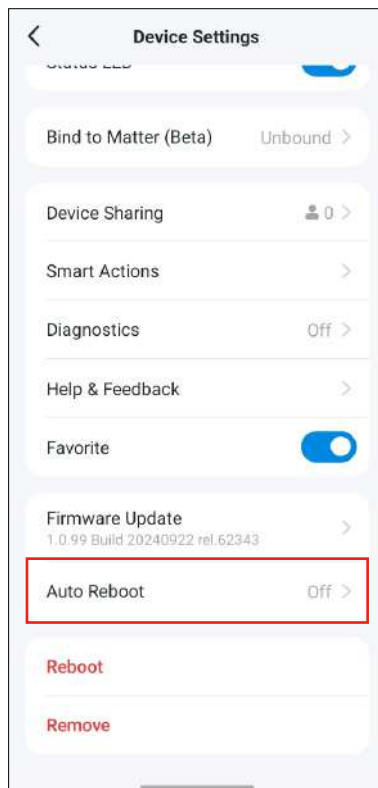

Reset Your HomeBase

There are three ways to reset your HomeBase.

Method 1. Remove Device on the Device Settings Page

Go to the [Device Settings](#) page. Tap [Remove](#) down below.

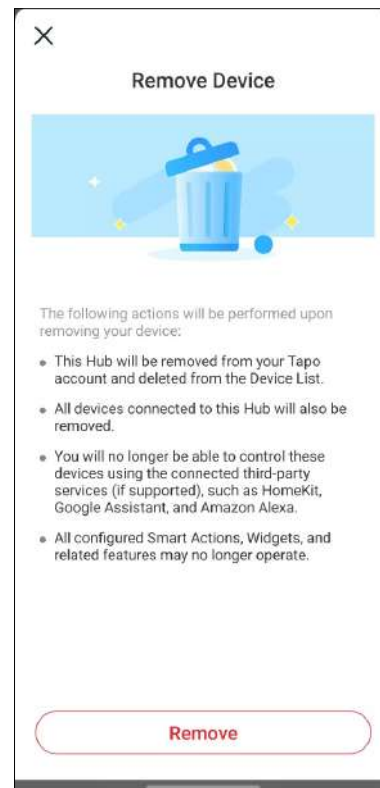
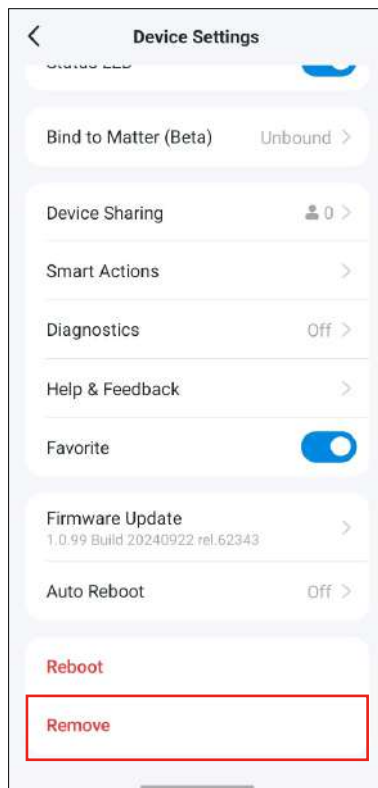

Method 2. Remove Device on the Home Page

Go to the [Home](#) page. Long press your device card and then tap .

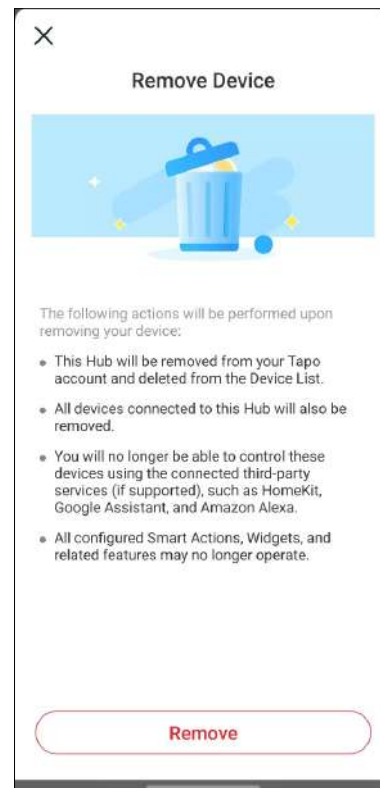
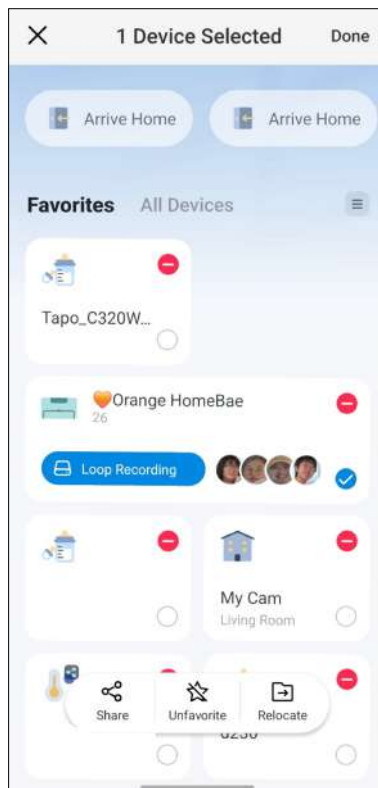

Method 3. Press the Reset Button on the HomeBase

Locate the Reset button at the back panel of your HomeBase. Use a pin to press and hold the [Reset](#) button for 10 seconds to restore factory default settings.

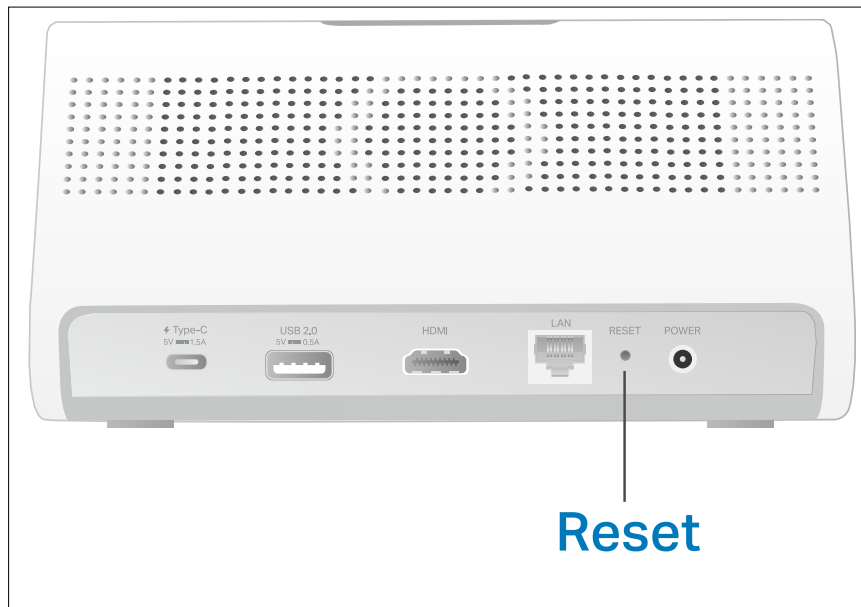

Authentication

FCC compliance information statement



Product Name: Smart HomeBase

Model Number: Tapo H500

Component Name	Model
I.T.E. Power	T120200-2B4

Responsible Party:

TP-Link Systems Inc.

Address: 10 Mauchly, Irvine, CA 92618

Website: <http://www.tp-link.com/us/>

Tel: +1 626 333 0234

Fax: +1 909 527 6804

E-mail: sales.usa@tp-link.com

This equipment has been tested and found to comply with the limits for a Class B digital device, pursuant to part 15 of the FCC Rules. These limits are designed to provide reasonable protection against harmful interference in a residential installation. This equipment generates, uses and can radiate radio frequency energy and, if not installed and used in accordance with the instructions, may cause harmful interference to radio communications. However, there is no guarantee that interference will not occur in a particular installation. If this equipment does cause harmful interference to radio or television reception, which can be determined by turning the equipment off and on, the user is encouraged to try to correct the interference by one or more of the following measures:

- Reorient or relocate the receiving antenna.
- Increase the separation between the equipment and receiver.
- Connect the equipment into an outlet on a circuit different from that to which the receiver is connected.
- Consult the dealer or an experienced radio/ TV technician for help.

This device complies with part 15 of the FCC Rules. Operation is subject to the following two conditions:

1. This device may not cause harmful interference.
2. This device must accept any interference received, including interference that may cause undesired operation.

Any changes or modifications not expressly approved by the party responsible for compliance could void the user's authority to operate the equipment.

Note: The manufacturer is not responsible for any radio or TV interference caused by unauthorized modifications to this equipment. Such modifications could void the user's authority to operate the equipment.

FCC RF Radiation Exposure Statement

This equipment complies with FCC RF radiation exposure limits set forth for an uncontrolled environment. This device and its antenna must not be co-located or operating in conjunction with any other antenna or transmitter.

"To comply with FCC RF exposure compliance requirements, this grant is applicable to only Mobile Configurations. The antennas used for this transmitter must be installed to provide a separation distance of at least 20 cm from all persons and must not be co-located or operating in conjunction with any other antenna or transmitter."

We, **TP-Link Systems Inc.**, has determined that the equipment shown as above has been shown to comply with the applicable technical standards, FCC part 15. There is no unauthorized change is made in the equipment and the equipment is properly maintained and operated.

Issue Date: 2024-10-28

FCC compliance information statement

Product Name: I.T.E. Power

Model Number: T120200-2B4

Responsible Party:

TP-Link Systems Inc.

Address: 10 Mauchly, Irvine, CA 92618

Website: <http://www.tp-link.com/us/>

Tel: +1 626 333 0234

Fax: +1 909 527 6804

E-mail: sales.usa@tp-link.com

This equipment has been tested and found to comply with the limits for a Class B digital device, pursuant to part 15 of the FCC Rules. These limits are designed to provide reasonable protection against harmful interference in a residential installation. This equipment generates, uses and can radiate radio frequency energy and, if not installed and used in accordance with the instructions, may cause harmful interference to radio communications. However, there is no guarantee that interference will not occur in a particular installation. If this equipment does cause harmful interference to radio or television reception, which can be determined by turning the equipment off and on, the user is encouraged to try to correct the interference by one or more of the following measures:

- Reorient or relocate the receiving antenna.
- Increase the separation between the equipment and receiver.
- Connect the equipment into an outlet on a circuit different from that to which the receiver is connected.
- Consult the dealer or an experienced radio/ TV technician for help.

This device complies with part 15 of the FCC Rules. Operation is subject to the following two conditions:

1. This device may not cause harmful interference.
2. This device must accept any interference received, including interference that may cause undesired operation.

Any changes or modifications not expressly approved by the party responsible for compliance could void the user's authority to operate the equipment.

Note: The manufacturer is not responsible for any radio or TV interference caused by unauthorized modifications to this equipment. Such modifications could void the user's authority to operate the equipment.

FCC RF Radiation Exposure Statement

This equipment complies with FCC RF radiation exposure limits set forth for an uncontrolled environment. This device and its antenna must not be co-located or operating in conjunction with any other antenna or transmitter.

“To comply with FCC RF exposure compliance requirements, this grant is applicable to only Mobile Configurations. The antennas used for this transmitter must be installed to provide a separation distance of at least 20 cm from all persons and must not be co-located or operating in conjunction with any other antenna or transmitter.”

We, **TP-Link Systems Inc.**, has determined that the equipment shown as above has been shown to comply with the applicable technical standards, FCC part 15. There is no unauthorized change is made in the equipment and the equipment is properly maintained and operated.

Issue Date: 2024-10-28

CE Mark Warning



This is a class B product. In a domestic environment, this product may cause radio interference, in which case the user may be required to take adequate measures.

OPERATING FREQUENCY (the maximum transmitted power)

2400MHz~2483.5MHz / 20dBm

5150 MHz -5250 MHz / 23dBm

5250 MHz -5350 MHz / 23dBm

5470 MHz -5725 MHz / 23dBm

EU Declaration of Conformity

TP-Link hereby declares that the device is in compliance with the essential requirements and other relevant provisions of directives 2014/53/EU, 2009/125/EC, 2011/65/EU and (EU)2015/863.

The original EU Declaration of Conformity may be found at <https://www.tapo.com/en/support/ce/>.

RF Exposure Information

This device meets the EU requirements (2014/53/EU Article 3.1a) on the limitation of exposure of the general public to electromagnetic fields by way of health protection.

The device complies with RF specifications when the device used at 20 cm from your body.

Frequency band: 5150 - 5250 MHz:

Indoor use: Inside buildings only. Installations and use inside road vehicles and train carriages are not permitted. Limited outdoor use: If used outdoors, equipment shall not be attached to a fixed installation or to the external body of road vehicles, a fixed infrastructure or a fixed outdoor antenna. Use by unmanned aircraft systems (UAS) is limited to within the 5170 - 5250 MHz band.

Frequency band: 5250 - 5350 MHz:

Indoor use: Inside buildings only. Installations and use in road vehicles, trains and aircraft are not permitted. Outdoor use is not permitted.

Frequency band: 5470 - 5725 MHz:

Installations and use in road vehicles, trains and aircraft and use for unmanned aircraft systems (UAS) are not permitted.

	AT	BE	BG	CH	CY	CZ	DE	DK
	EE	EL	ES	FI	FR	HR	HU	IE
	IS	IT	LI	LT	LU	LV	MT	NL
	NO	PL	PT	RO	SE	SI	SK	UK(NI)

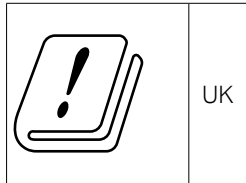

Attention: This device may only be used indoors in Great Britain.

UKCA Mark



UK Declaration of Conformity

TP-Link hereby declares that the device is in compliance with the essential requirements and other relevant provisions of the Radio Equipment Regulations 2017.

The original UK Declaration of Conformity may be found at <https://www.tapo.com/support/ukca/>.

Canadian Compliance Statement

This device contains licence-exempt transmitter(s)/receiver(s) that comply with Innovation, Science and Economic Development Canada's licence-exempt RSS(s). Operation is subject to the following two conditions:

1. This device may not cause interference.
2. This device must accept any interference, including interference that may cause undesired operation of the device.

L'émetteur/récepteur exempt de licence contenu dans le présent appareil est conforme aux CNR d'Innovation, Sciences et Développement économique Canada applicables aux appareils radio exempts de licence. L'exploitation est autorisée aux deux conditions suivantes :

1. l'appareil ne doit pas produire de brouillage;
2. l'utilisateur de l'appareil doit accepter tout brouillage radioélectrique subi, même si le brouillage est susceptible d'en compromettre le fonctionnement

Caution: The device for operation in the band 5150–5250 MHz is only for indoor use to reduce the potential for harmful interference to co-channel mobile satellite systems;

Avertissement: Le dispositif fonctionnant dans la bande 5150-5250 MHz est réservé uniquement pour une utilisation à l'intérieur afin de réduire les risques de brouillage préjudiciable aux systèmes de satellites mobiles utilisant les mêmes canaux;

Radiation Exposure Statement:

This equipment complies with IC radiation exposure limits set forth for an uncontrolled environment. This equipment should be installed and operated with minimum distance 20cm between the radiator & your body.

Déclaration d'exposition aux radiations:

Cet équipement est conforme aux limites d'exposition aux rayonnements IC établies pour un environnement non contrôlé. Cet équipement doit être installé et utilisé avec un minimum de 20 cm de distance entre la source de rayonnement et votre corps.

Industry Canada Statement

CAN ICES-3 (B)/NMB-3(B)

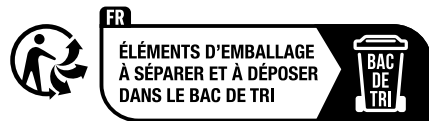

Korea Warning Statements:

당해 무선설비는 운용중 전파혼신 가능성이 있음.

NCC Notice & BSMI Notice

注意!

取得審驗證明之低功率射頻器材，非經核准，公司、商號或使用者均不得擅自變更頻率、加大功率或變更原設計之特性及功能。

低功率射頻器材之使用不得影響飛航安全及干擾合法通信；經發現有干擾現象時，應立即停用，並改善至無干擾時方得繼續使用。

前述合法通信，指依電信管理法規定作業之無線電通信。

低功率射頻器材須忍受合法通信或工業、科學及醫療用電波輻射性電機設備之干擾。

應避免影響附近雷達系統之操作。

安全諮詢及注意事項

- 請使用原裝電源供應器或只能按照本產品注明的電源類型使用本產品。
- 清潔本產品之前請先拔掉電源線。請勿使用液體、噴霧清潔劑或濕布進行清潔。
- 注意防潮，請勿將水或其他液體潑灑到本產品上。
- 插槽與開口供通風使用，以確保本產品的操作可靠並防止過熱，請勿堵塞或覆蓋開口。
- 請勿將本產品置放於靠近熱源的地方。除非有正常的通風，否則不可放在密閉位置中。
- 不要私自拆開機殼或自行維修，如產品有故障請與原廠或代理商聯繫。

限用物質含有情況標示聲明書

設備名稱：Tapo 智慧網關		型號（型式）： Tapo H500				
Equipment name		Type designation (Type)				
單元 Unit	限用物質及其化學符號 Restricted substances and its chemical symbols					
	鉛 Lead (Pb)	汞 Mercury (Hg)	鎘 Cadmium (Cd)	六價鉻 Hexavalent chromium (Cr ⁺⁶)	多溴聯苯 Polybrominated biphenyls (PBB)	多溴二苯醚 Polybrominated diphenyl ethers (PBDE)
PCB	○	○	○	○	○	○
外殼	○	○	○	○	○	○

電源供應器	—	○	○	○	○	○
其他及其配件	—	○	○	○	○	○

備考 1. “超出 0.1 wt %” 及 “超出 0.01 wt %” 係指限用物質之百分比含量超出百分比含量基準值

Note 1: “Exceeding 0.1 wt %” and “exceeding 0.01 wt %” indicate that the percentage content of the restricted substance exceeds the reference percentage value of presence condition.

備考 2. “○” 係指該項限用物質之百分比含量未超出百分比含量基準值。

Note 2: “○” indicates that the percentage content of the restricted substance does not exceed the percentage of reference value of presence.

備考 3. “—” 係指該項限用物質為排除項目。

Note 3: The “—” indicates that the restricted substance corresponds to the exemption.



Продукт сертифіковано згідно с правилами системи УкрСЕПРО на відповідність вимогам нормативних документів та вимогам, що передбачені чинними законодавчими актами України.

EAC

Safety Information

- Never touch the product with wet hands.
- Do not disassemble, repair or modify the product.
- Do not use the device where wireless devices are not allowed.
- Do not use the product if the casing has been broken. Danger of electric shock.
- Keep the device away from water, fire, humidity or hot environments.
- Do not use damaged charger or USB cable to charge the device.
- Do not use any other chargers than those recommended.
- Do not use the device where wireless devices are not allowed.
- Adapter shall be installed near the equipment and shall be easily accessible.
- Do not place near automatically controlled devices such as fire alarms. Radio waves emitted from this product may cause such devices to malfunction resulting in an accident.
- Observe restrictions on using wireless products in fuel depots, chemical plants or when blasting operations are in progress.
- Do not use liquid to clean the product. Only use a dry cloth.
- Never put metal objects inside the product. If a metal object enters the product turn off the circuit breaker and contact an authorised electrician.
- This product is not intended to be used when providing medical care. Consult the manufacturer of any personal medical devices, such as pacemakers or hearing aids to determine if they are adequately shielded from external RF (radio frequency) energy.
- Do not use this product in health care facilities. Hospitals or health care facilities may be using equipment that could be sensitive to external RF energy.
- Do not use this product near water for example near a bath tub, wash bowl, kitchen sink or laundry tub, in a wet basement or near a swimming pool.
- The product should be kept free from excessive smoke, dust or high temperature and vibration.
- This product should not be exposed to direct sunlight
- Do not place heavy objects on top of the product.
- This product may interfere with other electronic products such as TV, radios, personal computers, phones or other wireless devices.
- This equipment shall be installed at a height of fewer than 2 meters when sticking to a clean wall.

- a) Remove and immediately recycle or dispose of used batteries according to local regulations and keep away from children. Do NOT dispose of batteries in household trash or incinerate.
- b) Even used batteries may cause severe injury or death.
- c) Call a local poison control center for treatment information.
- d) This product includes button/coin cell batteries of type CR1220.
- e) The nominal voltage of the button/coin cell batteries is 3.0 V.
- f) Non-rechargeable batteries are not to be recharged.
- g) Do not force discharge, recharge, disassemble, heat above (manufacturer's specified temperature rating) or incinerate. Doing so may result in injury due to venting, leakage or explosion resulting in chemical burns.

This product contains non-replaceable button/coin cell batteries. In order to avoid unnecessary danger, please do not attempt to remove and replace the button/coin cell batteries.











Doorbell Operating Temperature: -20 °C ~ 45°C (-4°F ~ 113°F)











Chime Operating Temperature: 0 °C ~ 40°C (32°F ~ 104°F)



Please read and follow the above safety information when operating the device. We cannot guarantee that no accidents or damage will occur due to improper use of the device. Please use this product with care and operate at your own risk.

Explanation of the symbols on the product label

Note: The product label is on the bottom of the product. Symbols may vary from products.

Symbol	Explanation
	Class II equipment
	Class II equipment with functional earthing
	Alternating current
	DC voltage
	Polarity of output terminals
	Indoor use only
	Dangerous voltage
	Caution, risk of electric shock
	Energy efficiency Marking
	Protective earth
	Earth

Symbol	Explanation
	Frame or chassis
	Functional earthing
	Caution, hot surface
	Caution
	Operator's manual
	Stand-by
	"ON"/"OFF" (push-push)
	Fuse
	Fuse is used in neutral N
	<p>RECYCLING</p> <p>This product bears the selective sorting symbol for Waste electrical and electronic equipment (WEEE). This means that this product must be handled pursuant to European directive 2012/19/EU in order to be recycled or dismantled to minimize its impact on the environment.</p> <p>User has the choice to give his product to a competent recycling organization or to the retailer when he buys a new electrical or electronic equipment.</p>

Symbol	Explanation
	Caution, avoid listening at high volume levels for long periods
	Disconnection, all power plugs
m	Switch of mini-gap construction
μ	Switch of micro-gap construction (for US version) Switch of micro-gap / micro-disconnection construction (for other versions except US)
ε	Switch without contact gap (Semiconductor switching device)

Other ManualsLib Projects



www.manualslib.com



www.manualslib.de



www.manualslib.es



www.manualslib.fr



www.manualslib.nl



www.manualslib.mx



www.manualslib.tech 30+ Languages