

EST 2015

ZULAY
KITCHEN

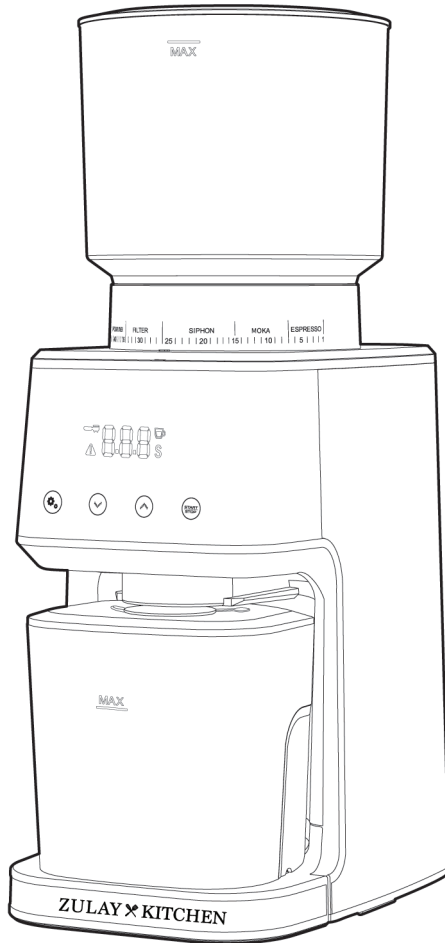

COFFEE GRINDER

INSTRUCTION MANUAL

Thank You for Your Purchase

Thank you for choosing our Coffee Grinder for your home brewing needs. We truly appreciate your purchase and the trust you have placed in our product.

Our Coffee Grinder is designed to deliver exceptional grinding performance, allowing you to enjoy the freshest and most flavorful coffee experience. With its advanced features and durable construction, we are confident that it will meet and exceed your expectations.

We have put great care into creating a grinder that not only delivers consistent and precise grinding results but also provides ease of use and cleaning. The high-quality materials used in its construction ensure long-lasting performance, allowing you to enjoy freshly ground coffee for years to come.

Should you have any questions, concerns, or need any assistance with your new Coffee Grinder, our dedicated customer support team is here to help. We take pride in providing exceptional customer service and will gladly assist you with any inquiries you may have.

Once again, we extend our heartfelt gratitude for choosing our Coffee Grinder. We hope it brings you many delightful moments and enhances your coffee brewing experience. Your satisfaction is our utmost priority, and we are committed to delivering excellence in every aspect of our product and service.

Thank you for being a valued customer. We look forward to serving you again in the future.

CONTENTS

SAFETY INFORMATION	01-02
TECHNICAL SPECIFICATIONS	02
PARTS OF THE GRINDER	03
HOW TO ASSEMBLE AND DISASSEMBLE THE BEAN HOPPER	04
HOW TO ATTACH PORTAFILTER CRADLE & PORTAFILTER	05
HOW TO USE THE COFFEE GRINDER	06-07
GRIND SIZE SETTINGS RECOMMENDATION	07
CONTROL PANEL OPERATION INSTRUCTIONS	08-09
MAKING BETTER QUALITY COFFEE	10
CLEANING	11-12
TROUBLESHOOTING	13-14
WARRANTY AND CONTACT INFORMATION	15

SAFETY INFORMATION

When using electrical appliances, basic safety precautions should always be followed:

- Carefully read all instructions before operating the appliance for the first time and save for future reference.
- When the machine is not in use, before handling or cleaning its parts, always remember to unplug it. To unplug, firmly grasp the plug and pull it out from the electrical outlet. Avoid pulling on the cord itself.
- To protect against fire, electric shock, and injury to persons, do not immerse the cord, plugs, or the machine in water.
- To minimize the risk of severe injury or damage to the appliance, ensure that hands and other objects are kept away from the coffee bean hopper during the grinding process.
- If the grinder has a damaged cord or plug, or if it malfunctions, or if it is dropped or damaged in any way, do not continue operating it. For assistance, please contact our customer service team.
- The use of attachments that are not recommended or sold by the manufacturer can potentially result in fire, electric shock, or injuries.
- This product is intended for indoor use only.
- Avoid allowing the cord to hang over the edge of the counter or come into contact with hot surfaces.
- Do not allow foreign objects to enter the coffee bean hopper.
- Ensure that the lid is securely in place when operating the burr grinder.
- Avoid placing the appliance on or near a hot gas or electric burner, or inside a heated oven.
- This product is intended for household use only. Any commercial use, improper use, or failure to follow the instructions will result in the voiding of the manufacturer's warranty.
- This appliance is only intended for use of roasted coffee beans. Do not use the appliance for any other purpose or with ingredients such as hard seeds, spices, nuts, etc.

SAFETY INFORMATION

- This appliance is not intended for use by persons (including children) with reduced physical, sensory or mental capabilities or lack of experience and knowledge, unless they have been given supervision or instruction concerning use of the appliance by a person responsible for their safety.
- The appliance is not intended for use by children.
- Always disconnect the appliance from the power supply if it will be left unattended or before assembling, disassembling, or cleaning.
- When disposing of electronic equipment, it is advisable to use certified electronics recyclers or authorized recycling facilities. These facilities are equipped to handle electronic waste properly, ensuring that hazardous materials are managed appropriately.
- Be careful when handling burrs as they are sharp. Never touch them with your fingers!

TECHNICAL SPECIFICATIONS

Model	BD-CG018
Rated Power	165W
Rated Voltage	120V
Bean Hopper Capacity	12.5oz
Ground Coffee Container Capacity	5.3oz
Dimensions	4.5 x 7 x 13.5 inches

If you have any questions about the unit or its operation, please call or email customer service.

☎ +1(727) 386-9117 ⌚ Mon-Fri 9:00 AM - 5:00 PM (EST) ✉ support@zulay.net

PARTS OF THE GRINDER

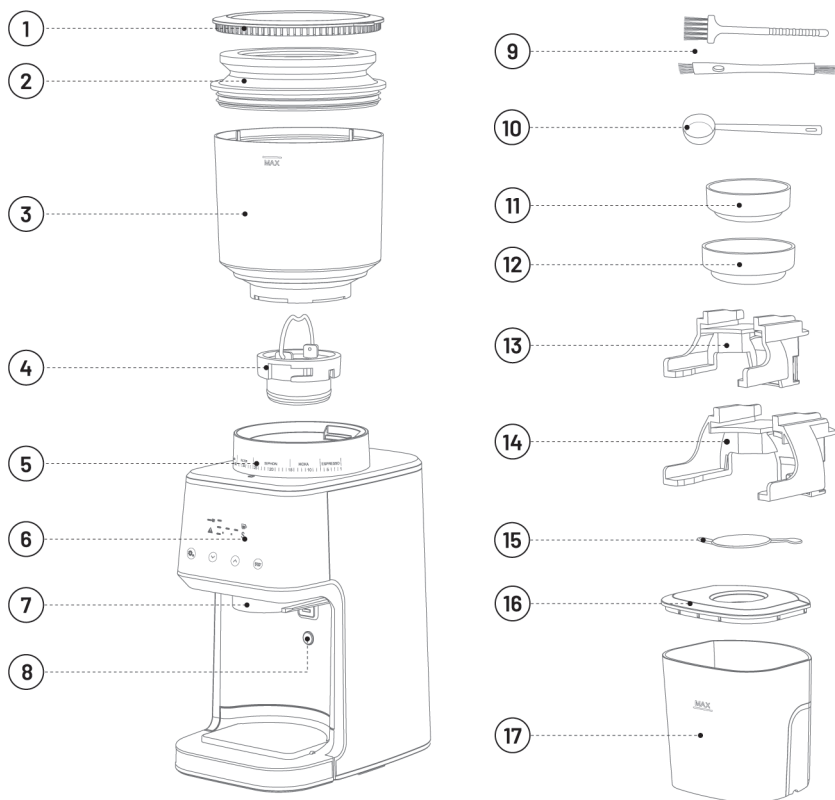

- ① Bean Hopper Lid
- ② Coffee Grounds Residual Cleaner
- ③ Bean Hopper
- ④ Stainless Steel Conical Burrs
- ⑤ Grind Size Control
- ⑥ Control Panel
- ⑦ Ground Coffee Chute
- ⑧ Portafilter Activation Switch
- ⑨ Cleaning Brushes
- ⑩ Scoop
- ⑪ Coffee Dosing Ring Compatible with 53mm Portafilter
- ⑫ Coffee Dosing Ring Compatible with 58mm Portafilter
- ⑬ Portafilter Cradle 53mm
- ⑭ Portafilter Cradle 58mm
- ⑮ Silicone Cover
- ⑯ Ground Coffee Container Lid
- ⑰ Ground Coffee Container

HOW TO ASSEMBLE AND DISASSEMBLE THE BEAN HOPPER

How to assemble the Bean Hopper:

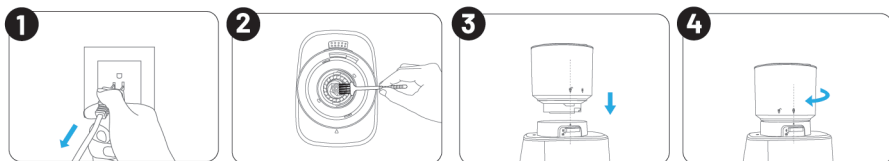

1. Make sure the coffee grinder is unplugged.
2. Please ensure that the top part of the conical burr is clean. If it's not, use the brush provided to clean it.
3. Align the unlock icon (🔓) on the Bean Hopper with the arrow (▲) on the base.
4. Hold the Grind Size Control with one hand and turn the Bean Hopper clockwise with the other hand until the lock icon (🔒) is aligned with the arrow (▲).

NOTE:

If Bean Hopper has not been locked into position, the "E1" message will be displayed on the control panel disabling the operation of the grinder for safety.

How to disassemble the Bean Hopper:

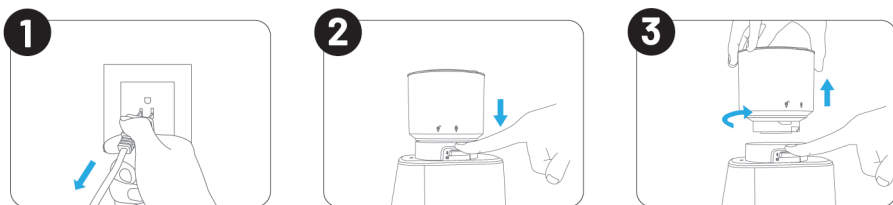

1. Make sure the coffee grinder is unplugged.
2. To release the Bean Hopper, press the Bean Hopper release lever located in the back of the Grind Size Control.
3. The Bean Hopper will turn counterclockwise, and you can now lift it up.

HOW TO ATTACH PORTAFILTER CRADLE & PORTAFILTER

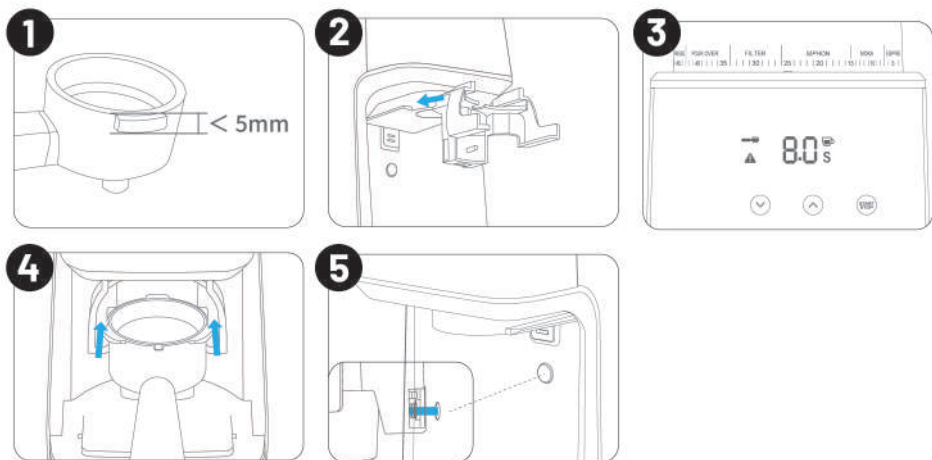

1. Ensure that the Portafilter you are using has ribs that are not thicker than 5mm.

2. Attach the Portafilter Cradle as shown in the above image until you hear the click.

3. Once the cradle is properly installed, the espresso mode will activate, causing the espresso icon to illuminate and three buttons to light up. At this point, you can adjust the grinding time by pressing the arrow buttons. The minimum time is 5 seconds and the maximum is 15 seconds.

4. To properly attach the portafilter, align it with the corresponding slot on the lower end of the Portafilter Cradle, and slide it horizontally into position.

5. After setting the grinding time, simply push the Portafilter forward, ensuring that it makes contact with the Portafilter Activation Switch. Once the designated time has elapsed, the grinding will stop automatically. If you wish to stop grinding before the designated time, push on the Portafilter again.

HOW TO USE THE COFFEE GRINDER

Before using the Coffee Grinder for the first time and before plugging it in, wash accessories such as the Bean Hopper, Cradles, Ground Coffee Container, and Ground Coffee Container Lid in warm, soapy water, and air-dry them fully. Additionally, wipe the exterior of the base with a soft, slightly damp cloth, and ensure it is fully dry before plugging it in.

Important: Do not immerse the base into water!

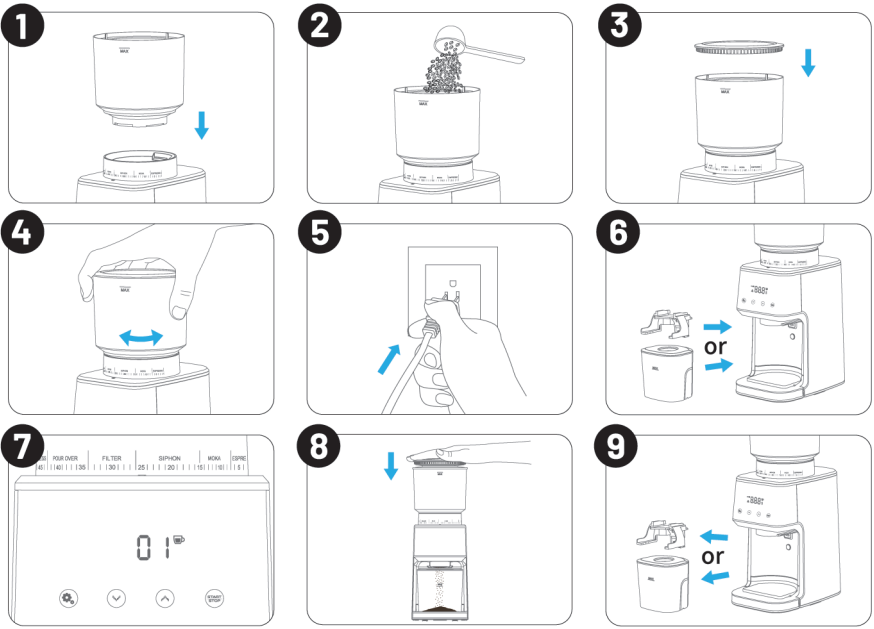

1. Assemble the Bean Hopper by following the instructions provided on page 4.

2. Fill the Bean Hopper with coffee beans.

3. Close the lid.

4. Select grind size.

The coffee grinder offers 51 grind size options. To adjust the grind size, simply rotate the Bean Hopper from fine to coarse based on your desired coffee type. For recommended grind size settings, please refer to page 7 of the user manual.

5. Plug the coffee grinder into a power outlet.

After powering on the system, the buzzer will emit a single beep, and the screen will display "888".







HOW TO USE THE COFFEE GRINDER

- Place the Ground Coffee Container or attach the Cradle to your grinder.
- If you have placed the Ground Coffee Container, the screen will display "01 cup" with four buttons lighting up. To switch from adjusting the number of cups to the time, simply double-click the "Settings" button. The screen will show 10 seconds for the grinding time, and you can now increase or decrease it by pressing the arrow buttons. Press the "Start/Stop" button to begin the grinding process.
If you have placed the Cradle, the screen will display 8 seconds with 3 lights on for grinding beans for the espresso. Adjust the grinding time by pressing arrow buttons, and then place the Portafilter. To start grinding, simply push the Portafilter forward, and the Portafilter Activation Switch will engage. Once the designated time has elapsed, the grinding will stop automatically. If you wish to stop grinding before the designated time, simply push on the Portafilter again.
- After grinding, utilize the Coffee Grounds Residual Cleaner to remove any remaining coffee residue from the product. Simply replace the Bean Hopper Lid with the Coffee Grounds Residual Cleaner. Push down to effectively remove any remaining ground coffee from the chute.
- Remove the Ground Coffee Container or Portafilter.

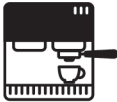
Using the Dosing Ring

Place the included Dosing Ring on your Portafilter when grinding directly into it, and hold the Portafilter under the chute. Press Start/Stop button to start grinding.

GRIND SIZE SETTINGS RECOMMENDATION

	Espresso	Moka Pot	Siphon	Drip Coffee Machine	Pour Over	French Press
Coffee Type						
Grind Size	Fine	Medium Fine	Medium	Lightly Coarse	Medium Coarse	Coarse
Grind Setting	1-7	8-15	16-26	27-34	35-43	44-51

CONTROL PANEL OPERATION INSTRUCTIONS

The Coffee Grinder has 4 buttons:

 The Settings button allows you to navigate between adjusting the number of cups, the grinding time, and setting up defaults for a single cup.

 Time/Cup Decrease

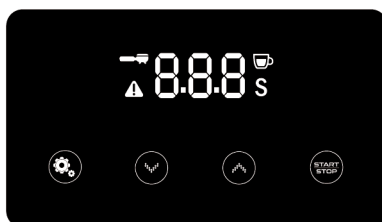

 Time/Cup Increase

 Start/Stop button /Pulse mode



Select the method you prefer to control the grinding process. It can be either the number of cups or seconds, and even fractions of seconds for very precise grinding. Additionally, you have the option to set the default for a single cup and save it.

SETTING UP THE NUMBER OF CUPS

To set the desired number of cups for grinding, ensure that the Ground Coffee Container is in place and all four lights are illuminated. By default, the screen will display "01 cup" with a grinding time of 4 seconds per cup. To increase the number of cups, simply press the () button. Each press will add one cup, starting from 1 and going up to 12. Conversely, to decrease the number of cups, press the () button.

CHANGING DEFAULT SETTINGS FOR A SINGLE CUP

The current default setting is 4 seconds per cup. To set up the time and save it as the default for 1 cup, place the Ground Coffee Container, ensure the screen displays 0.1 cup, press and hold the Settings button for 3 seconds to enter the single cup working time selection, use the arrow buttons to choose between 3 and 5 seconds of grinding per cup, and briefly press the Settings button to save the settings. The settings will be saved even if you unplug the device.

SETTING UP GRINDING TIME

To switch from selecting the number of cups to adjusting the grinding time, simply double click the () button. The default time is set to 10 seconds, and you can choose a time between 1 second and 60 seconds.

CONTROL PANEL OPERATION INSTRUCTIONS

When selecting a time between 1 and 15 seconds, each short press of the (⬆️) button will increase the time by 0.1 seconds. For example, it will go from 1.1 seconds to 1.2 seconds, and so on, up to 14.9 seconds. If you need to increase the time more rapidly, you can long press the (⬆️) button. On the other hand, when the time reaches 1 second, both short presses and long presses of the (⬇️) button will have the same effect.

Once you have set the desired time or number of cups, you can start grinding the beans by pressing the "Start/Stop" button. If you would like to stop the grinding process prior to completion, simply press the "Start/Stop" button.

GRINDING INTO THE PORTAFILTER

1. Insert the 53mm or 58mm Portafilter Cradle following the instructions on page 5. The default Portafilter grinding setting is 8 seconds. Press the arrow button to choose the grinding time, ranging from 5 to 15 seconds. A long press will increase the speed.

2. After setting the grinding time, simply push the Portafilter forward, ensuring that it makes contact with the Portafilter Activation Switch. Once the designated time has elapsed, the grinding will stop automatically. If you wish to stop grinding before the designated time, push on the Portafilter again.

PULSE MODE

By pressing and holding the "Start/Stop" button, the machine will enter the pulse working mode, and the screen will display the working time as 8.1, 8.2, 8.3, and so on. Release "Start/Stop" button to stop grinding. The maximum grinding time allowed in this mode is 20 seconds.

Note: The pulse mode will only work when the Portafilter Cradle is attached.

SOUND ON/OFF

To turn the sound on or off, simply press the two arrow buttons (⬆️)(⬇️) simultaneously.

ENERGY SAVING FEATURE

The grinder will automatically turn off if it remains unused for 3 minutes. To reactivate the machine while in POWER SAVING/SLEEP MODE, simply press "Start/Stop" button.

MAKING BETTER QUALITY COFFEE

- **Freshness is key:** To achieve a mellow and delicious cup of coffee, it is crucial to use fresh coffee beans. Adjust the coffee flavor and concentration according to your personal preferences by changing the type, amount, and grinding fineness of the coffee beans.
- **Opt for fresh coffee beans:** Look for coffee beans marked with the baking date to ensure maximum freshness. Store the beans in a dark, cool, and dry environment. If possible, consider vacuum packaging to preserve their flavor and aroma.
- **Buy in small quantities:** To minimize storage time, purchase coffee beans in small quantities. It is recommended to store them for no more than one week at a time to maintain their freshness.
- **Grind just before brewing:** Coffee beans lose their aromatic flavor quickly once ground into coffee powder. For the best brewing results, grind the beans immediately before brewing your coffee.
- **Avoid prolonged storage in the Bean Hopper:** It is not advisable to store coffee beans in the Bean Hopper for an extended period. Instead, use the grinder to grind the remaining coffee beans and clean the machine before storing it.
- **Regular cleaning:** Keep your Coffee Bean Grinder in optimal condition by cleaning the Bean Hopper and Ground Coffee Container regularly. This helps maintain the quality of the grounds and prevents any residue buildup that may affect the flavor of your coffee.

By following these tips, you can ensure a consistently enjoyable coffee experience with your Coffee Bean Grinder. Experiment with different beans, brewing methods, and grind sizes to discover your ideal taste. Enjoy your freshly brewed cup of coffee!

CLEANING





Regular cleaning is essential for ensuring consistent grinding results, especially for the burrs. It is important to clean the grinder at least once a month to prevent any coffee bean oil from getting stuck inside the grinding mechanism or on the surfaces, which can affect the performance and flavor of the ground coffee.



Be careful when handling burrs as they are sharp. Never touch them with your fingers!

1. Unplug the Coffee Grinder.
2. To unlock the Bean Hopper, simply press the lever located at the back of the Bean Hopper.
3. Remove the beans.
4. Securely lock the Bean Hopper in place.

CLEANING

5. Plug in the Coffee Grinder and run it until it is empty.
6. Unplug the grinder.
7. Replace the Bean Hopper Lid with the Coffee Grounds Residual Cleaner, and press it down. The air will expel any remaining ground coffee from the chute, effectively removing any leftover grounds. Please refer to image on page 11.
8. Remove the Bean Hopper.
9. Turn the Upper Burr counterclockwise and gently pull it upward using the metal handle to remove it.
10. Use the cleaning brush to clean the Upper Burr.
11. Clean the Lower Burr using the cleaning brush.
12. Brush the grinder outlet.
13. Hold the metal handle of the Upper Burr and align it with the "Unlock" position.
14. Lock the Upper Burr securely by turning it clockwise using the metal handle. Place the handle in a flat position.
15. Align the unlock icon () on the Bean Hopper with the arrow () on the base.
16. Turn the Bean Hopper clockwise until the lock icon () is aligned with the arrow () on the base.

Cleaning tips:

- Always unplug the Coffee Grinder from the power outlet before cleaning.
- To clean the grinder of any remaining ground coffee, please use the Coffee Grounds Residual Cleaner after each use. Please refer to step 7 in the Cleaning section.
- To preserve the aroma of your coffee and prevent the degradation of the ground coffee, empty the Ground Coffee Container after each use.
- Never place the grinder, power supply cord, or plug in water or under running water.
- Do not use strong detergents or abrasive pads to clean the appliance.
- Clean the accessories in warm, soapy water.

Important: Never immerse the base in water!

The parts of the Coffee Grinder are not dishwasher safe!

TROUBLESHOOTING

Issue	Reason	Solution
<p>E1 (on Control Panel)</p>	<p>1. No Bean Hopper. 2. The Bean Hopper is not connected properly.</p>	<p>Assemble the Bean Hopper or ensure that it is securely in place. Tighten the Bean Hopper until the microswitch is closed. Once the Bean Hopper is properly closed, the error code E1 should disappear.</p>
	<p>The motor's overheating protection, known as PTC (Positive Temperature Coefficient), activates in abnormal situations such as power blockage.</p>	<p>Unplug the power, clean the machine, and allow it to cool down before proceeding.</p>
<p>E2 (on Control Panel)</p>	<p>The unit is designed to operate continuously for four cycles, after which it will automatically power off to ensure protection and safety.</p>	<p>Unplug the power, allow the machine to cool down for 10 minutes, then restart.</p>
<p>The Coffee Grinder suddenly stops working.</p>	<p>Coffee bean debris or oil is stuck in the grinder.</p>	<p>Follow the cleaning instructions on page 11. If the problem persists even after cleaning, use Cleaning Tablets specifically designed for professional coffee grinders and follow the provided instructions precisely.</p>

TROUBLESHOOTING

Issue	Reason	Solution
My coffee is not flavorful.	<ol style="list-style-type: none"><li data-bbox="298 279 639 367">1. The grinding size isn't applicable for the brewing method.<li data-bbox="298 399 639 486">2. The coffee beans roasting date exceeds 3 weeks.	<ol style="list-style-type: none"><li data-bbox="639 279 978 367">1. Follow the Grind Size Recommendation Chart on page 7.<li data-bbox="639 399 978 678">2. It's recommended to use high quality, freshly roasted coffee beans. Consuming your coffee beans anywhere between 7-21 days after the stated roast date will give you the best-tasting coffee.

If your problem is not listed, then you can call us at **(727) 386-9117**
Mon-Fri 9:00 AM - 5:00 PM (EST),
or you can message us at **www.zulaykitchen.com/contact-us**