

EST  2015

ZULAY  
KITCHEN

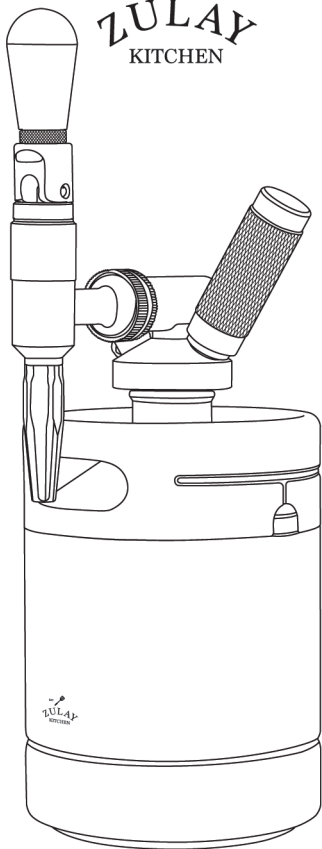

64oz Nitro Cold Brew Coffee Maker  
Instruction Manual

# CONTENTS

**01** SAFETY INFORMATION

**02** PRODUCT ORIENTATION

**03** SETTING UP THE UNIT

**07** CARTRIDGES

**08** CLEANING AND MAINTENANCE

**09** TROUBLESHOOTING

**11** RECIPES



# SAFETY INFORMATION

Please read this manual before using the unit and keep it for future reference. Operate the coffee maker as directed.

- When charging the Nitro Cold Brew keg, do not use more than one 8-gram N2O cartridge or two 2-gram N2 cartridges per keg.
- Nitrous oxide cartridges are to be used only for the purpose of making coffee. Do not inhale the contents of the cartridge, as misuse of nitrous oxide can be dangerous to your health.
- It is advised that children do not operate this appliance.
- Please ensure that the unit and its components are kept out of reach of children.
- Please refrain from using this unit for hot liquids or non-food items.
- Ensure that the cap is not placed on the keg until it is entirely dry.
- It is critical that you do not use the unit if the keg is dented or damaged. Please contact our customer service team immediately for assistance.
- Under no circumstances should you place the appliance on or near a hot gas or electric burner, in a heated oven, microwave, or freezer. Doing so may result in damage to the appliance and could pose a serious safety hazard.

# PRODUCT ORIENTATION



- ❶ Drip Mat
- ❷ Stainless Steel 64oz Keg
- ❸ Collapsible Funnel
- ❹ Stainless Steel Stout Faucet
- ❺ Black Tap Handle
- ❻ Stainless Steel Spear with Pressure Relieving Valve rated for 75PSI
- ❼ Cartridge/Capsule Holder
- ❽ Universal Wrench
- ❾ Faucet Cap
- ❿ Coffee Tubes
- ⓫ Faucet Cleaning Brush
- ⓬ Keg Brush

# SETTING UP THE UNIT

**1.** Clean all the parts of the unit with warm water and dish soap before use.

**2.** Pour a maximum of 48 ounces of store-bought or homemade cold brew coffee that has been filtered of coffee grounds. Please note that the recommended quantity should not exceed 48 ounces to prevent overfilling the 64-ounce keg, allowing room for expansion when adding nitro gas. In case the cold brew concentrate purchased is too strong, we advise to dilute it as per your preferred drinking ratio.

**Important Note:** Avoid adding dairy/non-dairy beverages or creamers, sugar, or sweeteners directly into the keg, as it may lead to blockage of the tap head. We recommend adding these elements to your glass before dispensing the coffee to prevent any operational difficulties.

**3.** Attach the coffee tube to the fitting of the coffee spear.

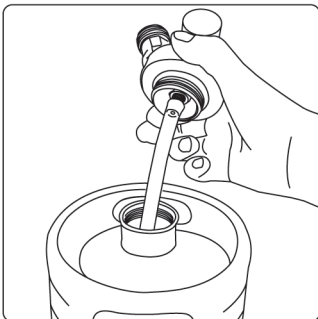
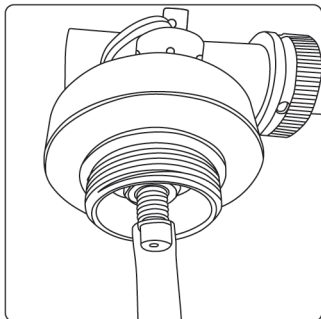

**4.** Install the faucet into the coffee spear and ensure that the connection is proper and tight.

**Note:** Incorrect combinations may cause coffee to leak.

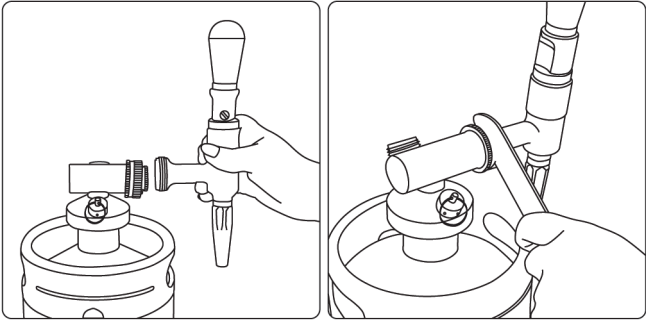

**5.** Insert one non-threaded 8g N2O cartridge or one 2g N2 cartridge into the cartridge holder, ensuring that the round edge of the cartridge is placed first into the cartridge holder. Please refer to the image on page 5.

**6.** Screw the cartridge holder onto the cartridge valve until you hear a "whoosh" sound. This indicates that the cartridge has been pierced and the gas has been injected into the keg.

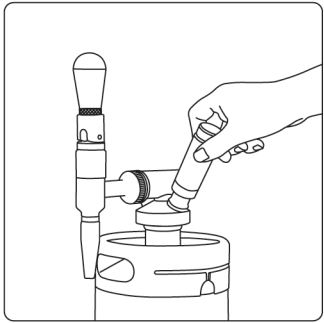
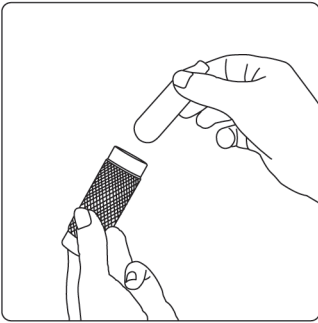

**Note:** It is normal to hear a slight amount of gas escaping and observe a few drops of coffee near the pressure release valve.

**7.** Unscrew the cartridge holder and discard the cartridge.

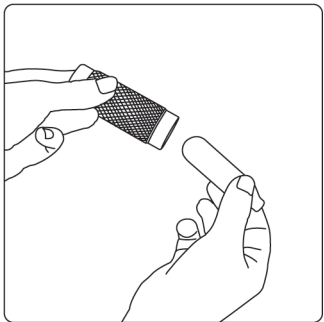
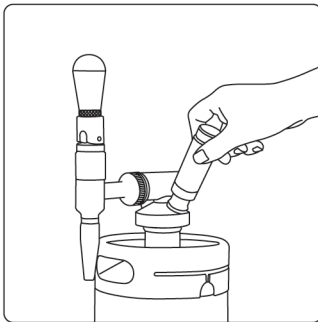

**8.** Shake the keg from side to side and up and down for 15 seconds.

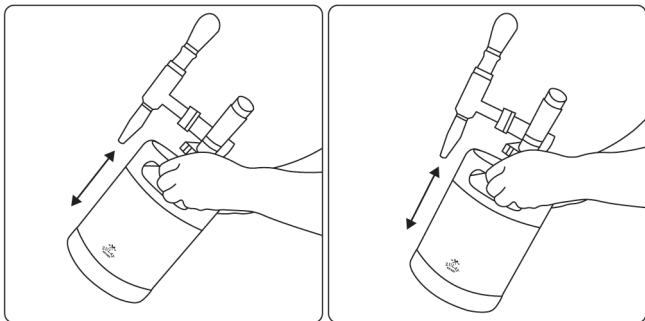

**9.** If you are using pure nitrogen (N<sub>2</sub>) cartridges with a capacity of 2 g, please allow the keg to rest for 20 minutes before charging it with the second N<sub>2</sub> cartridge.

**10.** Place the keg in the refrigerator and allow it to rest for at least one hour.

**11.** Remove the keg from the refrigerator and shake it for 15 seconds.

**12.** Position a glass under the spout and pull the tap handle forward to dispense the coffee.

**13.** Indulge in the rich, velvety texture and robust flavor of your perfectly crafted nitro coffee!

# CARTRIDGES

The Nitro Brew Coffee Maker is only compatible with two types of cartridges. Please ensure that you use cartridges that are 18mm in diameter and 65mm in length.

## **Nitrous Oxide (N<sub>2</sub>O) 8 g.**

When making nitro brew, a single nitrous oxide cartridge can be added to a 64 oz keg to infuse the coffee with nitrous oxide, resulting in a creamy, velvety texture that enhances the coffee's natural sweetness without adding any additional sugar. This cartridge provides thick foam.

## **Nitrogen (N<sub>2</sub>) 2g.**

Using two nitrogen (N<sub>2</sub>) cartridges per batch for a 64 oz keg will provide a classic stout flavor with smaller and fewer bubbles, resulting in a smooth and velvety mouthfeel that is highly desirable in Nitro Cold Brew. Follow the instructions on using the N<sub>2</sub> cartridges on page 6.

# CLEANING AND MAINTENANCE

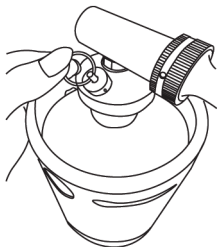

- To release any remaining gas in the keg, simply pull up on the pressure release valve.

- Unscrew both the faucet and spear top from the keg, and pour out any remaining coffee.

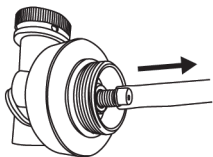
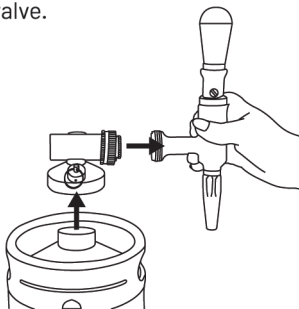

- Pull the coffee tube off the bottom of the spear fitting.

- Wash the keg, the tube, the spear top, and the faucet in warm water (dish soap can be used if necessary). Use the included brushes to thoroughly clean the inside of the keg and the faucet spout. Rinse thoroughly. Let it dry fully before attaching the cap or tap assembly.

**IMPORTANT:** The keg and other parts are not dishwasher safe. Always clean them manually.

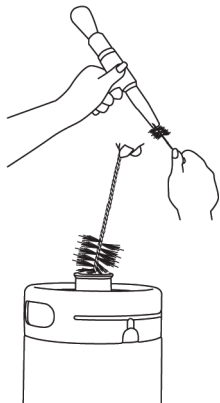

# TROUBLESHOOTING

## 1. Faucet leakage:

Solution: The fitting that connects the stainless steel spear to the stout faucet has four holes, which allows you to tighten the connection as needed. Use the included wrench or a standard wrench to tighten the connection until satisfied. Tightening by hand is also acceptable.

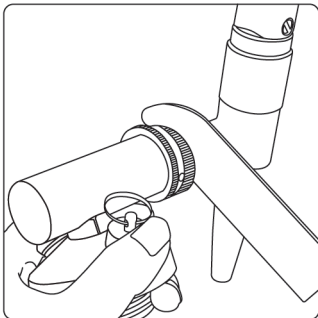
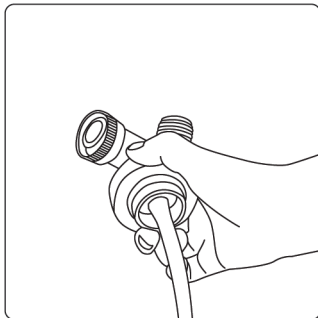

## 2. Spear Cross-Bar leakage

Solution: There is a screw located under the spear body that can become loose over time, and it can be tightened using the included wrench. Please refer to the images below.

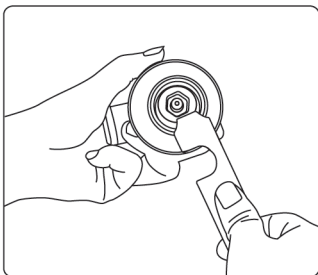
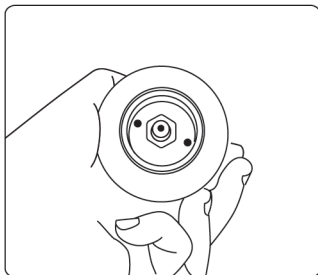

### 3. No foaming head, no cascading.

**Solution:** The coffee may have lost some of its foam due to a decrease in gas during storage or use. Try charging it with another cartridge.

### 4. Gas leakage when rotating cartridge holder.

Normally, some gas may escape through the hole in the bottom of the cartridge holder. To prevent gas leakage, quickly screw the cartridge holder on and ensure that it is screwed on all the way when adding a gas cartridge.

**Note:** When you have finished your Nitro Cold Brew and wish to remove the stainless steel spearhead, pull down on the black tap handle to allow the remaining Nitro Cold Brew and gas to drain out of the keg. This will release the pressure and make it easier to unscrew and remove the stainless steel spearhead for cleaning.

### 5. No "whoosh" sound heard when attaching the cartridge holder to the cartridge valve.

**Solution 1:** Reposition the cartridge holder as it may not be positioned correctly. Ensure that the holder is securely attached to the valve.

**Solution 2:** The cartridge holder may not be screwed on far enough. Turn the holder until you hear a "whoosh" sound, indicating that the cartridge has been punctured.

**Solution 3:** The cartridge may have been used or defective. Try using a new cartridge.

**Solution 4:** Ensure that you are using the correct cartridge size with a diameter of 18mm and a length of 65mm. The length of the neck is especially important. Using a cartridge with incorrect dimensions can cause issues with puncturing and pressure release.

# RECIPES

## Classic Nitro Cold Brew



This recipe includes the procedure for making Cold Brew coffee using a Cold Brew Coffee Maker. If you do not have a Cold Brew Coffee Maker, you can also purchase it pre-made.

### **Ingredients:**

- Coarsely ground coffee
- Water

### **Steps:**

1. Add coarsely ground coffee to the filter of your Cold Brew Maker, filling it about  $\frac{3}{4}$  full or following the manufacturer's instructions. You can always adjust the amount of coffee grounds for your next batch to make your cold brew stronger by adding more coffee grounds.

2. Place the filter into the Cold Brew Coffee Maker, taking care not to spill any coffee grounds out of the top of the maker. It is important to ensure that the coffee grounds stay contained in the filter to prevent grounds from ending up in your cold brew once it is made.
3. Pour filtered water (cold or room temperature) through the filter into the cold brew maker. Fill until about an inch from the top, or less if you want a stronger batch. Then twist the lid in place.
4. Allow to steep for 12-24 hours. If brewing in your fridge, brewing time takes longer towards the 24 hours. If brewing at room temperature, it will be less - but be sure to immediately refrigerate as soon as the brewing is complete.
5. Store your cold brew in the fridge until you are ready to make the Nitro Cold Brew. It usually lasts from 7 to 10 days when refrigerated.
6. Follow the instructions for using the Nitro Brew Keg, which can be found on page 3.
7. Serve the Classic Nitro Cold Brew straight from the dispenser, ideally in a glass that's been chilled in the freezer. Enjoy the smooth and creamy texture of Classic Nitro Cold Brew!

**Note:** You can adjust the ratio of coffee to water to suit your taste preferences.

## Vanilla Sweet Cream Nitro Brew



### **Ingredients:**

- 1/4 cup cold heavy cream
- 1 tablespoon vanilla syrup
- A pinch of salt
- 2-3 pumps of vanilla syrup
- 8-10 ounces of Nitro Cold Brew
- 2 tablespoons half and half (optional, if the sweet cream is too thick)

**Note:** The amounts can be adjusted to personal taste preferences.

### **Steps:**

1. Combine cold heavy cream, vanilla syrup and salt in a blender or use a handheld mixer/frother. Mix for 30 seconds or until the mixture slightly thickens.
2. Add 2-3 pumps of vanilla syrup to your glass.
3. Dispense your Nitro Cold Brew into the glass and top with the vanilla sweet cream.

**Note:** If the vanilla sweet cream is too thick to pour, add a couple of tablespoons of half and half.

## Nitro Cold Brew with Lemon and Cinnamon



### **Ingredients:**

- 1 cinnamon stick
- 1 slice of lemon

### **Steps:**

1. Chill your glass in the freezer for a while.
2. Add a stick of cinnamon and a slice of lemon to your glass.
3. Dispense your Nitro Cold Brew into the glass and enjoy the unique and refreshing combination of lemon and cinnamon flavors in your Nitro Cold Brew!

## Nitro Cold Brew Float



### **Ingredients:**

- 1 scoop of vanilla ice cream
- 8-10 ounces of Nitro Cold Brew

### **Steps:**

1. Scoop one scoop of vanilla ice cream into a glass.
2. Pour the Nitro Cold Brew over the ice cream.
3. Enjoy your delicious and creamy Nitro Cold Brew Float with a spoon and a straw.

**Note:** You can adjust the amount of ice cream or Nitro Cold Brew according to your personal taste preference. You can also use other flavors of ice cream to create your own unique flavor combinations.

## Nitro Cold Brew Mocha



### **Ingredients:**

- 8-10 ounces of Nitro Cold Brew
- 1 tablespoon chocolate syrup or cocoa powder
- 1 tablespoon sugar or sweetener of your choice
- 1/4 cup milk
- whipped cream (optional)

### **Steps:**

1. In a small saucepan, gently heat the milk on low heat until it begins to steam. Be careful not to let the milk boil.
2. Add chocolate syrup or cocoa powder to the hot milk and whisk until it's fully combined. Add sugar or sweetener if desired.
3. Pour the chocolate milk mixture into a glass, then add the Nitro Cold Brew Coffee to the same glass.
4. If desired, add ice to the glass.

5. Top with whipped cream (optional).
6. Enjoy your delicious Nitro Cold Brew Mocha!

**Note:** You can adjust the amount of chocolate syrup or cocoa powder, sugar or sweetener, and milk according to your personal taste preference. You can also use other flavors of syrup or add-ins to create your own unique flavor combinations.